

HAWORTH

UniGroup Too, UniGroup & PLACES

North America Price List – February 2024



Electronic Update Page – UniGroup Too Price Book

- The table below lists all of the updates and addendums added to this price list since the original version was created.
- All **Update** pages will replace the existing pages within the document.
- All **New** pages will be placed at the back of the document.

Link	Date	Page	Description
Click Here	March 2024	104, 105, 118-121, 130, 240	Update – The following products have been obsoleted: <ul style="list-style-type: none"> – PLACES Swing Door with Steel Top Cap Single Door Glazed – PLACES Tack Strip Monolithic High-Performance Acoustical Panels, – PLACES Tackboard Monolithic High-Performance Acoustical Panels – UniGroup Swing Doors with Steel Top Cap Single Door with ADA Lever and Kick Plate - Laminate – UniGroup Swing Doors with Steel Top Cap Single Door - Glazed – PLACES High-Performance Monolithic Fabric Panel with Steel Top Cap - No Power Fabric – PLACES High-Performance Monolithic Fabric Panel with Steel Top Cap - No Power Fabric – PLACES High-Performance Monolithic Fabric Panel with Steel Top Cap - Powered Fabric
Click Here	April 2024	28-32, 88-91	Update – The following products have been obsoleted: <ul style="list-style-type: none"> – UniGroup Too – Laminate Monolithic Panel – No Power – UniGroup Too – Laminate Monolithic Panel – Powered – UniGroup – Laminate Monolithic Panel with Steel Top Cap – No Power – UniGroup – Laminate Monolithic Panel with Steel Top Cap – Powered



This Haworth North American price book contains US list prices.

Canadian customers can convert the US list price into their Canadian equivalent by going to www.Haworth.com/Canada to find the current Canadian multipliers. These multiplier factors allow you to convert the US list price into a Canadian list price.

Price List Overview

The following overview explains how information is organized within the UniGroup® Too, UniGroup® and PLACES® price list.

- 1 Front Cover**
 - Includes the price book title and pricing effectivity date.
- 2 Canadian Conversion / Update Page**
 - Pricing conversion information for converting US pricing into the equivalent Canadian pricing is located on the footer of this page.
 - All Price Book updates will be listed on this page including the date, page number and description of the update.
- 3 Price List Table of Contents**
 - Price List table of contents with page numbers.
- 4 Statement of Line**
 - Provides a pictorial outline of the entire product offering.
- 5 Price List**

Each price list page contains the following:

 - Product Illustration
 - Catalog Number
 - To Order Specify – sequencing for ordering product options and finishes
 - List Prices
 - Product Specification Dimensions
 - Features
 - Specification Tips
 - Class, Discount Group Number (used for discounting) and GSA information
- 6 Finishes, Fabrics and COM**
 - Lists information for material finishes and availability.
 - Provides COM information and requirements (if applicable).
- 7 Index**
 - Products are listed alphabetically by alpha-numeric catalog numbers with price list page number.
- 8 Warranty Policy and Terms of Sale**
 - Provides information about the Haworth policy for non-obsolescence, warranty and Terms-of-Sale.

Additional Information and Resources

Prices are subject to change without notice or approval. Haworth dealers should always submit proposals through Lynx before presenting to customers. See North American Terms of Sale for more information.

Online Resources

haworth.com

- Haworth's corporate website provides access to price books and a variety of other resources and publications.

surfaces.haworth.com

- Website provides access to the most current fabrics and finishes offered across Haworth's various product lines.

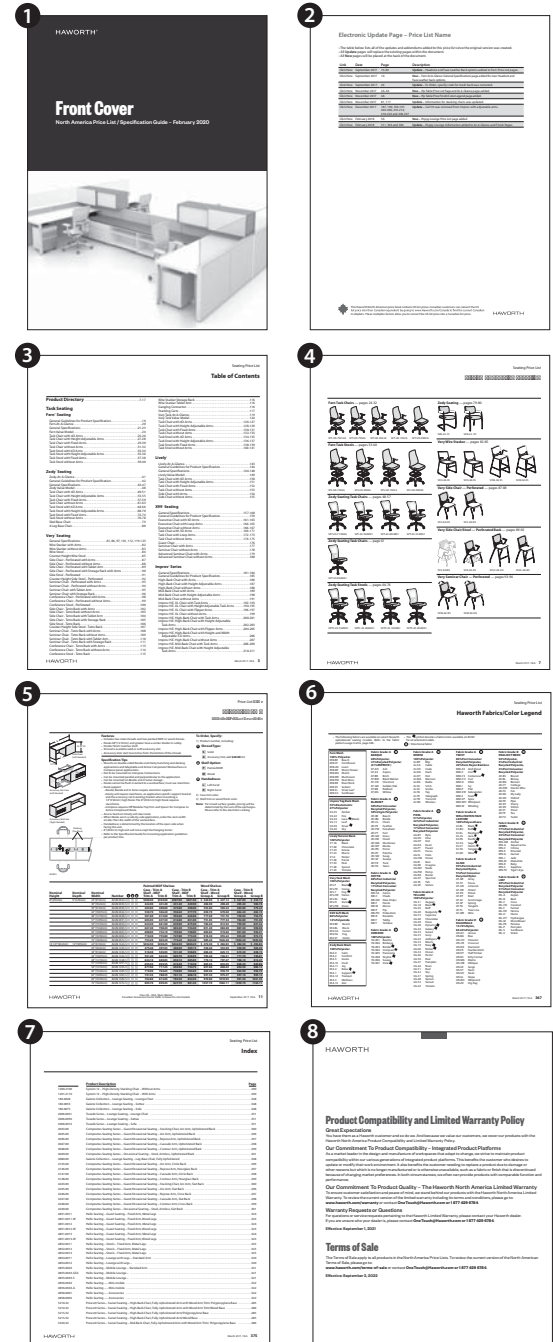

Table of Contents

Statement of Line	9-20
--------------------------------	------

UniGroup Too Panels

Basic Monolithic Panel — No Power	21
Basic Monolithic Panel — Powered	25
Laminate Monolithic Panel — No Power	28
Laminate Monolithic Panel — Powered	30
Fabric Monolithic Panel — No Power	33
Fabric Monolithic Panel — Powered	37
Monolithic Panel with Full-Height Inserts — No Power	41
Monolithic Panel with Full-Height Inserts — Powered	45
Monolithic Panel with Segmented Inserts — No Power	49
Monolithic Panel with Segmented Inserts — Powered	53
Monolithic Panel Core without Insert(s) — No Power	56
Monolithic Panel Core without Insert(s) — Powered	58
Glazed Monolithic Panel — No Power	60
Glazed Monolithic Panel — Powered	62
Base Insert	64
Upper Inserts	65
Fabric Add-On Panel	66
Glazed Add-On Panel	67

Panel Accessories

Sliding Door	68
Filler Post - Sliding Door	68

Swing Door

Single Door — Laminate	69
------------------------------	----

Panel Accessories

90° Full-Height Finish Post — Square Painted Top Cap	70
90° Variable-Height Finish Post — Square Painted Top Cap	70
90° Power Connector Cover — Square Profile	70
120° Full-Height Finish Post — Square Painted Top Cap	71
120° Variable-Height Finish Post — Square Painted Top Cap	71
120° Power Connector Cover	71
180° Full-Height Finish Post — Square Painted Top Cap	72
180° Variable-Height Finish Post — Square Painted Top Cap	72
180° Power Connector Cover	73
180° Vertical Cover only, (no top cap or base raceway cover)	73
90° Square Painted Top Cap for 2-Way, 3-Way, 4-Way	74
120° Square Painted Top Cap for 2-Way or 3-Way	74
UniGroup Too Top Cap Aligner	75
UniGroup Too Top Cap End Plug	75
Base Raceway End Cap	75
Full Height Side Trim Rail	76
Side Trim Rail	76
Hinges	77
Wall Track	77
Wall Mount Kit	77
T-Mount Kits	78
All-Purpose Hook	78
Seismic Anchoring Bracket	78
Friction Pad	78

UniGroup Panels

Monolithic Panel with Steel Top Cap — No Power	80
Monolithic Panel with Steel Top Cap — Powered	82
Basic Monolithic Panel with Steel Top Cap — No Power	84
Basic Monolithic Panel with Steel Top Cap — Powered	86
Laminate Monolithic Panel with Steel Top Cap — No Power	88
Laminate Monolithic Panel with Steel Top Cap — Powered	90
Open Frame Panel with Steel Top Cap — No Power	92
Open Frame Panel with Steel Top Cap — Powered	94
Glazed Monolithic Panel with Steel Top Cap — No Power	96
Glazed Monolithic Panel with Steel Top Cap — Powered	98
Fabric Add-On Panel	100
Glazed Add-On Panel	102

Swing Doors with Steel Top Cap

Single Door — Laminate	104
Single Door with ADA Lever and Kick Plate — Laminate	104
Single Door — Glazed	105

Panel Accessories

90° Finish Post — for Steel Top Cap — Painted Surface	106
90° Power Connector Cover	106
180° Power Connector Cover — Radius Profile	106
180° Finish Post — for Steel Top Cap — Painted Surface	106
Steel Top Cap for 3-Way and 4-Way	106
Full-Height Side Trim Rails — for use with Add-On Panels	107
Side Trim Rail	107
Hinges	107
Wall Track	108
Wall Mount Kit	108
T-Mount Kit — Center and End Conditions	108
All-Purpose Hook	109
Seismic Anchoring Bracket	109
Friction Pad	109

PLACES Fabrics

Monolithic Fabric Panel with Steel Top Cap — No Power	110
Monolithic Fabric Panel with Steel Top Cap — Powered	112
Basic Monolithic Fabric Panel with Steel Top Cap — No Power	114
Basic Monolithic Fabric Panel with Steel Top Cap — Powered	116
High-Performance Monolithic Fabric Panel with Steel Top Cap — No Power	118
High-Performance Monolithic Fabric Panel with Steel Top Cap — Powered	120
Glazed Monolithic Panels with Steel Top Cap — No Power	122
Glazed Monolithic Panels with Steel Top Cap — Powered	124
Fabric Add-On Panel	126
Glazed Add-On Panel	128

Swing Doors with Steel Top Cap

Single Door — Laminate	130
Single Door — Glazed	130

Table of Contents

Panel Accessories

90° Finish Post — for Steel Top Cap — Painted Surface	131
90° Power Connector Cover — Radius Profile	131
180° Finish Post — for Steel Top Cap — Painted Surface	131
180° Power Connector Cover	132
Steel Top Cap for 3-Way and 4-Way	132
Side Trim Rail With Notch	132
Panel Bridge	132
Full Height Side Trim Rail – for use with Add-On Panels	133
Hinges	133
Wall Track	134
Wall Mount Kit	134
All-Purpose Hook	135
Seismic Anchoring Bracket	135
Friction Pad	135

Panel Accessories – Retrofit Kits

Square Painted Top Caps	136
Trim Strip for UniGroup Fabric and Glazed Add-On Panels	136
90° Full-Height Finish Post — Square Painted Top Cap	137
90° Variable-Height Finish Post — Square Painted Top Cap	137
120° Full-Height Finish Post — Square Painted Top Cap	138
120° Variable-Height Finish Post — Square Painted Top Cap	138
180° Full-Height Finish Post — Square Painted Top Cap	139
180° Variable-Height Finish Post — Square Painted Top Cap	139
Square Painted Top Caps	140
90° Full-Height Finish Post — Square Painted Top Cap	140
90° Variable-Height Finish Post — Square Painted Top Cap	140
180° Full-Height Finish Post — Square Painted Top Cap	141
180° Variable-Height Finish Post — Square Painted Top Cap	141

Clerestory Kits

Straight Track Kit	144
2-Way Connector Kit	144
3-Way Connector Kit	144
4-Way Connector Kit	144
End Kit	144

Electrical Components

Base Feed Module – Hardwire Connection	145
Single Circuit Base Feed Module – Receptacle Connection with Power Cord	145
Base Feed Module — Concealed Hardwire Connection	147
Raised Floor Base Feed Module	147
Internal Power Base AI Feed	148
Wall Feed Field Wired 1 Port	148
Infeed Harness	149
Top Feed Module — UniGroup Too Only	150
Top Feed Module — UniGroup Only	151
Top Feed Module — PLACES Only	152
Plastic Liner — PLACES Only	152
Flexible Power Connector — Panel-to-Panel	153
Flexible Power Connector — Straight Span	154
Connector Assembly – 12” Pass-Through	154
Duplex Receptacle – 15 Amp	155
Raceway Retrofit Kit	156
Duplex Receptacle – 20 Amp	157
Raceway Cover – 20 Amp	157
Ported Raceway Covers	158

Electrical and Cable Management Accessories

Base Raceway End Cap	159
Cable Management Pole — One Channel – UniGroup Too and UniGroup Only	160
Cable Management Pole — Two Channels – UniGroup Too and UniGroup Only	160
Cable Management Pole – Panel Height – PLACES Only	161
Cable Management Pole – for 10’(3048mm)-High Ceiling – PLACES Only	161
Cable Management Pole – for 12’(3658mm)-High Ceiling – PLACES Only	162
Cable Management Post – Variable Height – PLACES Only	163
Cable Management Post – Variable Height – Two-Way 90° – PLACES Only	163
Cable Management Post – Variable Height — In-Line – PLACES Only	163
Cable Management Post – Variable Height – Three-Way 90° – PLACES Only	164
Power Breaker Marker	164
Expanded Top Cap Raceway – UniGroup Only	165
Expanded Top Finish Cap – UniGroup Only	165

Electrical Components — Hardwire

Base Feed Kit	167
Dual Power Access Raceway Kit — 4”-High Base Raceway	167
Blank Cover Plate	167
Raceway Covers	167

Table of Contents

Electrical Components — Hardwire / International

Top Feed Module – Hardwire / International – UniGroup Too Only	168
Top Feed Module – Hardwire / International – UniGroup Only	168
Top Feed Module – Hardwire / International – PLACES Only	169
Plastic Liner	169
International Power Components	170

Adaptable Worksurfaces

Rectangular	171
Rectangular Worksurface	174
Rectangular Adjustable Split Top	174
Rectangular Key	175
Rectangular Swell	176
Rectangular Inverse Swell	177
Rectangular Transition	178
Wedge	179
Sharp Wedge	181
Rectangular Radius End	182
Corner, 90° Straight Front	183
Corner, 90° Wrap-Around	184
Corner, 90° Notched	185
Corner, 90° Angled	186
Corner 90° Worksurface	187
Corner 90° Adjustable Split Top	187
Corner, 90° Wrap-Around Transitional	188
Corner, 90° Notched Transitional	189
Corner, 90° Angled – Transitional	190
Corner, 90° Wrap-Around Extended	192
Corner, 90° Notched Extended	194
Corner, 90° Wrap-Around Transitional Extended	197
90° Merger	200
Corner, 120° Wrap-Around	201
D-Shaped Convergent	202
Rectangular Convergent	203
D-Shaped Convergent, Wrap-Around	204
D-Shaped Ender	206
Bent	207
Countertop	208
Conference End	209
Key Conference End	210
120° Link	211

Worksurface Supports

Standard Cantilever Bracket	212
Standard Mini Cantilever Bracket	212
Standard Link Cantilever Bracket	212
Standard Snap-n-Fit Cantilever Bracket for Rectangular Worksurfaces	213
Standard Snap-n-Fit Mini Cantilever Bracket for Rectangular Worksurfaces	213
Standard Snap-n-Fit Cantilever Bracket for Corner Worksurface	214
Standard Snap-n-Fit Mini Cantilever Bracket for Corner Worksurface	214
Anti Dislodgement Bracket for use with Worksurface Support Panels	214
Side Bracket	215
Convergent Mount Bracket	215
Flush Mount Plate	215
Rear-Corner Bracket	215
Counter Top Brackets	215

Adaptable Worksurface Supports

Pedestal-to-Panel Bracket	216
Worksurface Support Panels	217

Worksurface Supports

Straight Leg Basic	218
Support Column	218
Double Support Leg	219
Single Support Leg	219
Support Post	219

Worksurface Accessories

Make-A-Corner	220
---------------	-----

Adaptable Upper Storage

Straight Mini Shelf, Standard Mount	221
Corner Mini Shelf, Standard Mount	221

Mini Shelves with Loop Bracket

Straight Mini-Shelf, with Loop Bracket	222
Corner Mini-Shelf, with Loop Bracket	222

Adaptable Upper Storage

Open Shelf, Standard Mount	223
Overhead Storage Unit / Shelf Gang Clip	223
Overhead Storage Unit, Standard Mount – Painted Door	224
Overhead Storage Unit, Standard Mount – Translucent Door	225
Overhead Storage Unit, Standard Mount – Wood Door	226
Overhead Storage Unit, Standard Mount – Laminate Door	227
Overhead Storage Unit, Up Mount – Painted Door	228
Overhead Storage Unit, Up Mount – Translucent Door	229
Overhead Storage Unit, Up Mount – Wood Door	230
Overhead Storage Unit, Up Mount – Laminate Door	231

Wall Mount Components

Overhead Storage Unit, Wall Mount – Painted Door	232
Overhead Storage Unit, Wall Mount – Translucent Door	233
Overhead Storage Unit, Wall Mount – Wood Door	234
Overhead Storage Unit, Wall Mount – Laminate Door	235

Shelf Accessories

Adaptable Shelf Dividers	236
Wall Track	236

Wall Mount Components

Back for Wall Mounted Overhead Storage Unit	237
Worksurface Wall Bracket	237
Tackboard, Wall Mount	238
Markerboard, Wall Mount	238
Slat, Wall Mount	238

Tack Strips/Tackboards

Tack Strip	239
Tackboard	239
Tack Strip — Monolithic High-Performance Acoustical Panels	240
Tackboard — Monolithic High-Performance Acoustical Panels	240

Table of Contents

Markerboards/Wall Accessory Slat Pad

Markerboard — Non-Magnetic Surface	241
Wall Accessory Slat Pad	241

Markerboard Accessories

Markerboard Accessories	242
-------------------------------	-----

Belong Work Tools Mounting Rails

Tool Rail — Worksurface Mount C-Clamp or Thru-Mount	243
Tool Rail — Single Post — C-Clamp or Thru-mount	244

Lighting — Task

Reed Premier™ Stand-Alone LED Task Light	245
Reed Premier™ Starter LED Task Light	245
Reed Premier™ Add-On LED Task Light — For Use with Reed Premier Starter LED Task Lights	246
Reed Premier™ Add-On Occupancy Sensor	246

Lighting — Haworth

Adaptable LED Task Light - Stand-Alone	247
Adaptable LED Task Light - Starter Kit	247
Adaptable LED Task Light - Add-On Kit	248

Finishes and Fabrics

Finish/Color Legend	249
Fabrics/Color Legend	250

COM Yardage Requirements

251-262

Index

263-270

Lifetime Product Warranty

Inside Back Cover

This page intentionally blank

Statement of Line

UniGroup Too Panels — pages 21-68



E2MN-B
Basic Monolithic Panel — No Power — Fabric

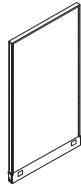

E2MP-B
E2MP-2
E2MP-4
Basic Monolithic Panel — Powered — Fabric



E2DN-B
Monolithic Panel — No Power — Laminate



E2DP-B
E2DP-2
E2DP-4
Monolithic Panel — Powered — Laminate

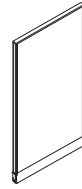

E2FN-B
Monolithic Panel — No Power — Fabric



E2FP-B
E2FP-2
E2FP-4
Monolithic Panel — Powered — Fabric

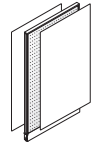

E2LN-B
Monolithic Panel with Full-Height Inserts — No Power — Fabric Inserts

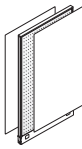

E2LP-B
E2LP-2
E2LP-4
Monolithic Panel with Full-Height Inserts — Powered — Fabric Inserts

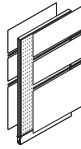

E2SN-B
Monolithic Panel with Segmented Inserts — No Power — Fabric Inserts

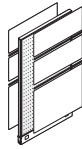

E2SP-B
E2SP-2
E2SP-4
Monolithic Panel with Segmented Inserts — Powered — Fabric Inserts



E2BN-B
Monolithic Panel Core without Insert(s) — No Power — Panel Core



E2BP-B
E2BP-2
E2BP-4
Monolithic Panel Core without Insert(s) — Powered — Panel Core



E2GN-B
Glazed Monolithic Panel — No Power — Glazed

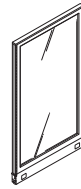

E2GP-B
E2GP-2
E2GP-4
Glazed Monolithic Panel — Powered — Glazed

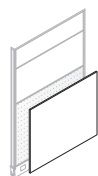
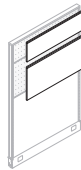

E2JF
Base Insert — Fabric

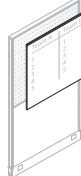

E2TF
E2TM
Upper Insert — Fabric or Markerboard

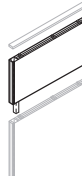

E2AM
Fabric Add-On Panel — Fabric

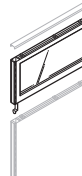

E2AG
Glazed Add-On Panel — Glazed

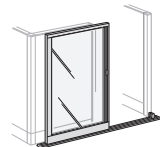

VUZF
Sliding Door

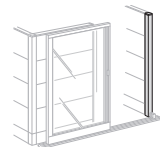

VEZP
Filler Post - Sliding Door

UniGroup Too Swing Door — page 69



E2DS
Single Door — Laminate

Statement of Line

UniGroup Too Panel Accessories — pages 70-78

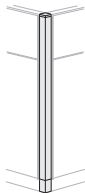

E2FC
E2PC
90° Full-Height Finish Post — Square Painted Top Cap

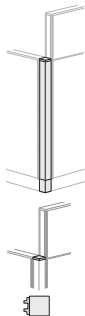

E2FC-V
E2PC-V
90° Variable-Height Finish Post — Square Painted Top Cap

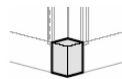

E2PC-90-B
90° Power Connector Cover — Square Profile

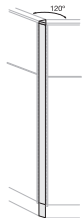

E2FA
E2PA
120° Full-Height Finish Post — Square Painted Top Cap

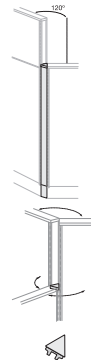

E2FA-V
E2PA-V
120° Variable-Height Finish Post — Square Painted Top Cap

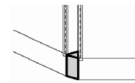

E2PC-120-B
120° Power Connector Cover



E2FS
E2PS
180° Full-Height Finish Post — Square Painted Top Cap



E2FS-V
E2PS-V
180° Variable-Height Finish Post — Square Painted Top Cap

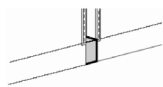

PPC-180-B
180° Power Connector Cover

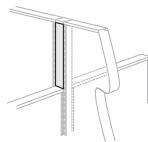

E2PS-N
E2FS-N
180° Vertical Cover only, (no top cap or base raceway cover)

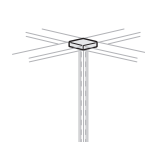

E2CC-90
90° Square Painted Top Cap for 2-Way, 3-Way, 4-Way

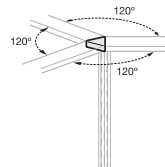

E2CA-120
120° Square Painted Top Cap for 2-Way or 3-Way

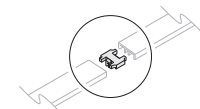

E2AL-1
UniGroup Too Top Cap Aligner



E2EC-1
UniGroup Too Top Cap End Plug



EC-10-B
Base Raceway End Cap

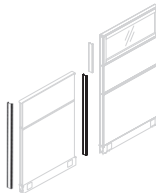

SREH
Full Height Side Trim Rail — for use with Add-On Panels



SRE
Side Trim Rail



HE
Hinges

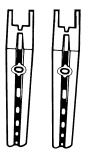

WT
Wall Track



WMK
Wall Mount Kit

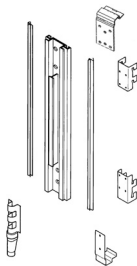

E2TK
T-Mount Kits

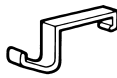

E2CH-8
All-Purpose Hook



HAB
Seismic Anchoring Bracket



7031-0501
Friction Pad

Statement of Line

UniGroup Panels — pages 80-103



EFN-B
Monolithic Panel with Steel Top Cap — No Power — Fabric



EFP-2
EFP-4
Monolithic Panel with Steel Top Cap — Powered — Fabric



EMN-B
Basic Monolithic Panel with Steel Top Cap — No Power — Fabric



EMP-2
EMP-4
Basic Monolithic Panel with Steel Top Cap — Powered — Fabric



EDN-B
Monolithic Panel with Steel Top Cap — No Power — Laminate



EDP-2
EDP-4
Monolithic Panel with Steel Top Cap — Powered — Laminate

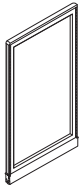

EON-B
Open Frame Panel with Steel Top Cap — No Power — Open-Frame



EOP-2
EOP-4
Open Frame Panel with Steel Top Cap — Powered — Open-Frame



EGN-B
Monolithic Panel with Steel Top Cap — No Power — Glazed

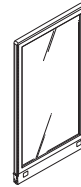

EGP-2
EGP-4
Monolithic Panel with Steel Top Cap — Powered — Glazed



EAF
Add-On Panel — Fabric



EAG
Add-On Panel — Glazed

UniGroup Swing Doors with Steel Top Cap — pages 104-105

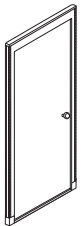

EDS-BKL
EDS-BHL
Single Door — Laminate

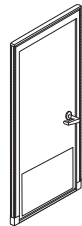

EAC-4280-BHL
Single Door with ADA Lever and Kick Plate — Laminate



EDG-BKL
EDG-BHL
Single Door — Glazed

UniGroup Panel Accessories — pages 106-0

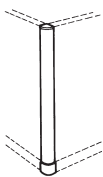

FPPC-B
90° Finish Post — for Steel Top Cap — Painted Surface



PCC-90-B
90° Power Connector Cover

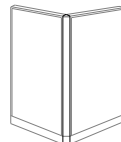

SPLA-1524
SPLB-2878
120° Finish Post — for Steel Top Cap — Fabric Surface

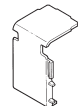

PCC-180-B
180° Power Connector Cover — Radius Profile

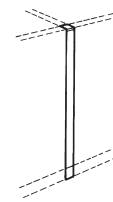

FPFS-B
180° Finish Post — for Steel Top Cap — Fabric Surface

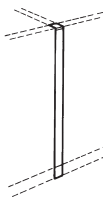

FPPS-B
180° Finish Post — for Steel Top Cap — Painted Surface



FPC-2
Steel Top Cap for 3-Way and 4-Way



SREH
Full-Height Side Trim Rails — for use with Add-On Panels



SRE
Side Trim Rail



HE
Hinges

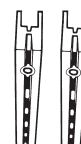

WT
Wall Track

Statement of Line

UniGroup Panel Accessories (cont'd) — pages 106-109



WMK
Wall Mount Kit

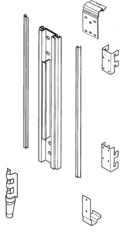

TMKT-B
T-Mount Kit — Center and End Conditions



CH-8
All-Purpose Hook



HAB
Seismic Anchoring Bracket



7031-0501
Friction Pad

PLACES Panels — pages 110-124



HFN
Monolithic Fabric Panel with Steel Top Cap — No Power — Fabric



HFP
HFP-A
HFP-D
Monolithic Fabric Panel with Steel Top Cap — Powered — Fabric



HMN
Basic Monolithic Fabric Panel with Steel Top Cap — No Power — Fabric

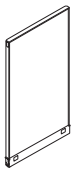

HMP
HMP-A
HMP-D
Basic Monolithic Fabric Panel with Steel Top Cap — Powered — Fabric



HFN-H
High-Performance Monolithic Fabric Panel with Steel Top Cap — No Power — Fabric



HFP-H
HFP-H2
HFP-H4
High-Performance Monolithic Fabric Panel with Steel Top Cap — Powered — Fabric

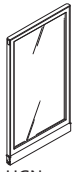

HGN
Monolithic Panels with Steel Top Cap — No Power — Glazed

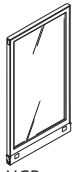

HGP
HGP-2
HGP-4
Monolithic Panels with Steel Top Cap — Power — Glazed

PLACES Add-On Panels — pages 126-129



HAF
Fabric



HAG
Glazed



HDS-L
Single Door — Laminate



HDG-L
HDG-R
Single Door — Glazed

PLACES Panel Accessories — pages 131-0

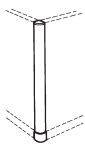

HDPC
90° Finish Post — for Steel Top Cap — Painted Surface



PCC-90-B
90° Power Connector Cover — Radius Profile

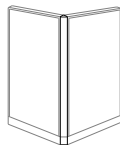

SPLA-1270
120° Finish Post — for Steel Top Cap — Fabric Surface



HDPS
180° Finish Post — for Steel Top Cap — Painted Surface

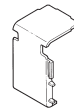

PCC-180-B
180° Power Connector Cover

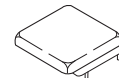

HTF-0004
Steel Top Cap for 3-Way and 4-Way



HRE
Side Trim Rail With Notch

Statement of Line

PLACES Panel Accessories (cont'd) — pages 131-135

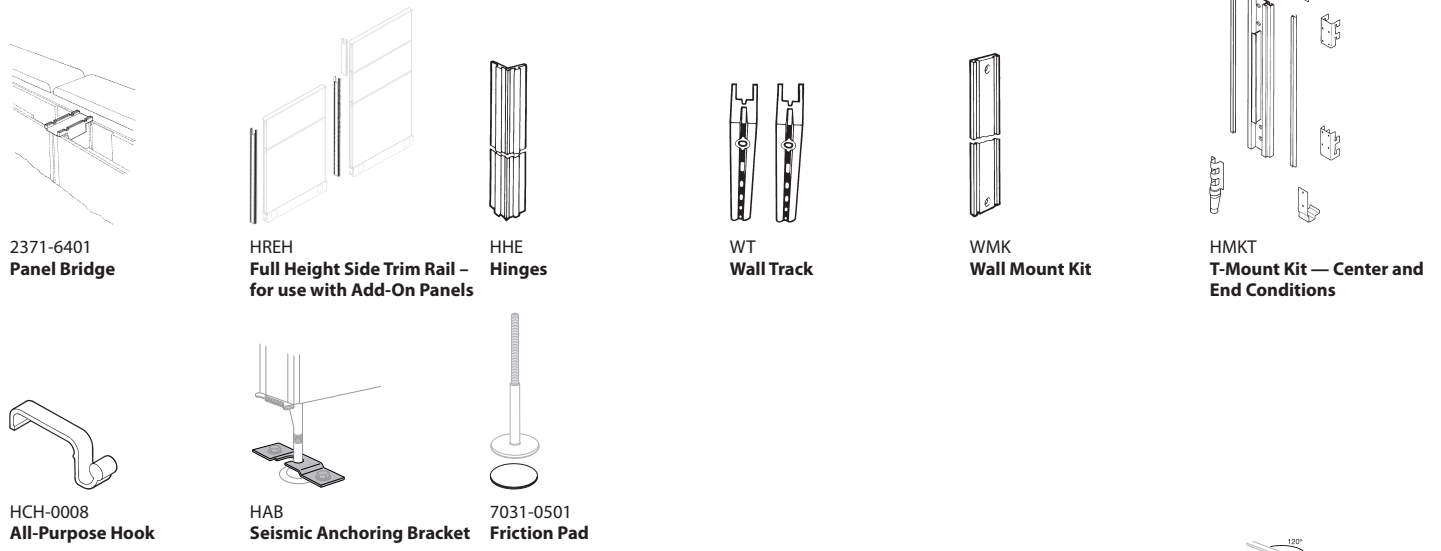

2371-6401
Panel Bridge

HREH
Full Height Side Trim Rail – for use with Add-On Panels

HHE
Hinges

WT
Wall Track

WMK
Wall Mount Kit

HMKT
T-Mount Kit — Center and End Conditions

HCH-0008
All-Purpose Hook

HAB
Seismic Anchoring Bracket

7031-0501
Friction Pad

Panel Accessories — Retrofit Kits — pages 136-141

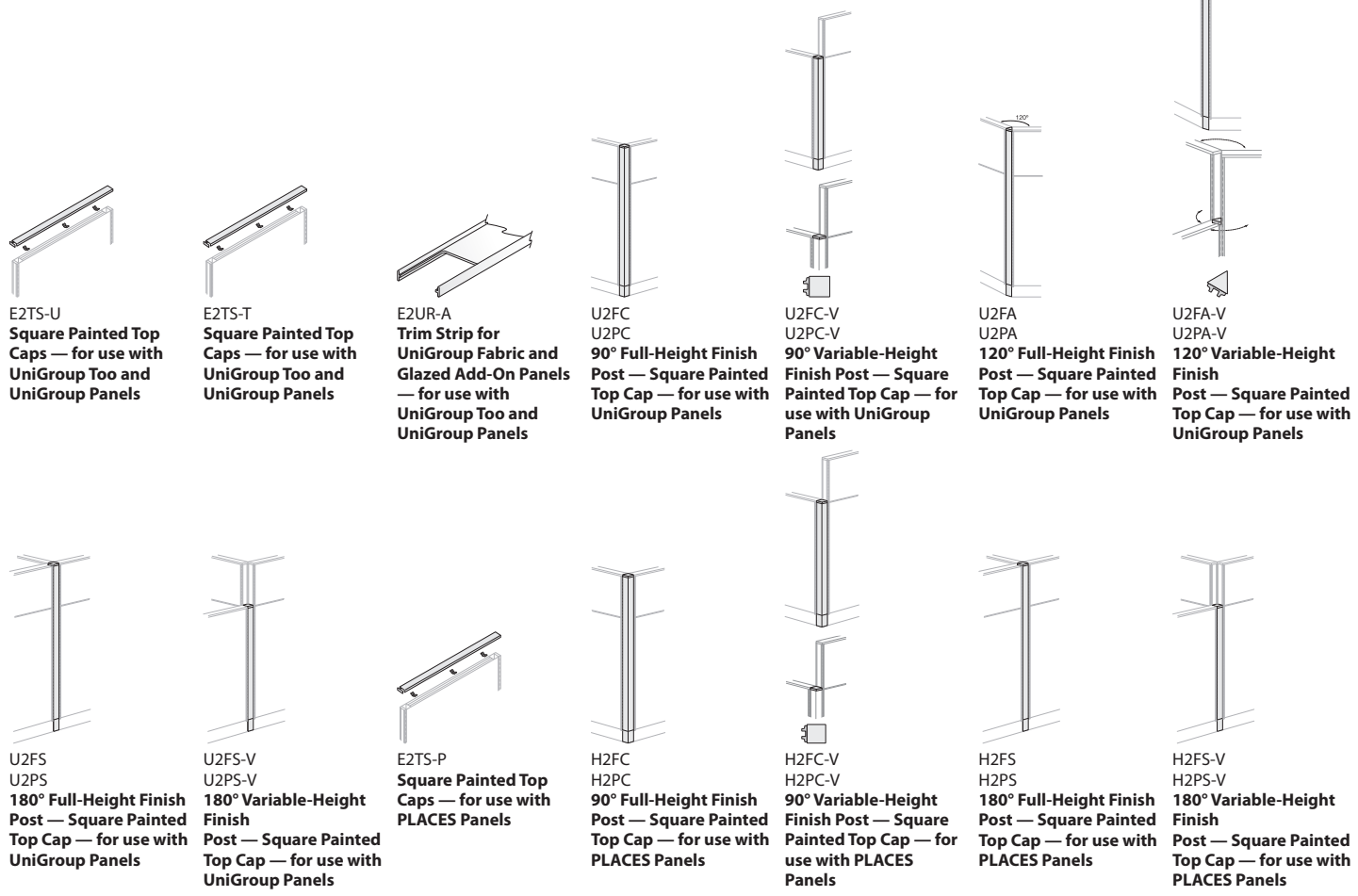

E2TS-U
Square Painted Top Caps — for use with UniGroup Too and UniGroup Panels

E2TS-T
Square Painted Top Caps — for use with UniGroup Too and UniGroup Panels

E2UR-A
Trim Strip for UniGroup Fabric and Glazed Add-On Panels — for use with UniGroup Too and UniGroup Panels

U2FC
U2PC
90° Full-Height Finish Post — Square Painted Top Cap — for use with UniGroup Panels

U2FC-V
U2PC-V
90° Variable-Height Finish Post — Square Painted Top Cap — for use with UniGroup Panels

U2FA
U2PA
120° Full-Height Finish Post — Square Painted Top Cap — for use with UniGroup Panels

U2FA-V
U2PA-V
120° Variable-Height Finish Post — Square Painted Top Cap — for use with UniGroup Panels

U2FS
U2PS
180° Full-Height Finish Post — Square Painted Top Cap — for use with UniGroup Panels

U2FS-V
U2PS-V
180° Variable-Height Finish Post — Square Painted Top Cap — for use with UniGroup Panels

E2TS-P
Square Painted Top Caps — for use with PLACES Panels

H2FC
H2PC
90° Full-Height Finish Post — Square Painted Top Cap — for use with PLACES Panels

H2FC-V
H2PC-V
90° Variable-Height Finish Post — Square Painted Top Cap — for use with PLACES Panels

H2FS
H2PS
180° Full-Height Finish Post — Square Painted Top Cap — for use with PLACES Panels

H2FS-V
H2PS-V
180° Variable-Height Finish Post — Square Painted Top Cap — for use with PLACES Panels

Statement of Line

Clerestory Kits — for use with UniGroup Too, UniGroup, PLACES — page 144

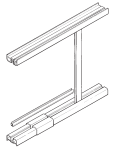

SPCL-1616
Straight Track Kit



SPCL-1613
2-Way Connector Kit

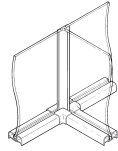

SPCL-1614
3-Way Connector Kit

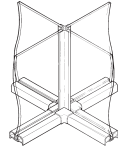

SPCL-1615
4-Way Connector Kit

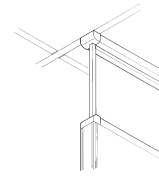

SPCL-1622
End Kit

Electrical Components — pages 145-159

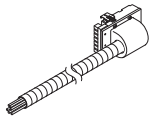

BFM-1-B
BFM-1-B2
BFM-1-B4
Base Feed Module —
Hardwire Connection —
UniGroup Too, UniGroup,
PLACES

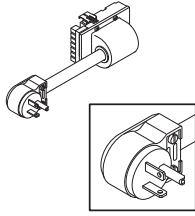

BFM-2-B
BFM-2-B2
BFM-2-B4
Single Circuit Base Feed
Module — Receptacle
Connection with Power
Cord — UniGroup Too,
UniGroup, PLACES

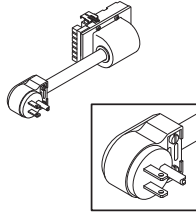

BFM-2-A
BFM-2-A2
BFM-2-A4
Single Circuit Base Feed
Module — Receptacle
Connection with Power
Cord — UniGroup Too,
UniGroup, PLACES

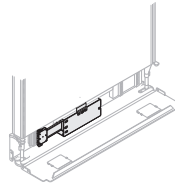

BFM-6-B
BFM-6-B2
BFM-6-B4
Base Feed Module —
Concealed Hardwire
Connection — UniGroup
Too, UniGroup, PLACES

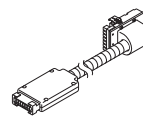

EBEJ-0072-3WF
EBEJ-0072-2WF
EBEJ-0072-4WF
Raised Floor Base Feed
Module — UniGroup Too,
UniGroup, PLACES

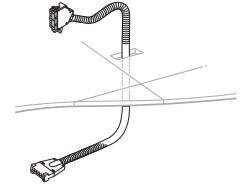

EUEJ-3WF
EUEJ-2WF
EUEJ-4WF
Internal Power Base AI
Feed — UniGroup Too,
UniGroup, PLACES

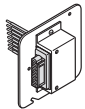

FBEW
Wall Feed Field
Wired 1 Port — UniGroup
Too, UniGroup, PLACES



VEEH-3
VEEH-2
VEEH-4
Infeed Harness —
UniGroup Too,
UniGroup, PLACES



E2FM
E2FM-2
E2FM-4
E2FM-X
Top Feed Module —
UniGroup Too Only —



TFM-B
TFM-B2
TFM-B4
TFM-X
Feed Module —
UniGroup Only



HTFM
HTFM-2
HTFM-4
HTFM-X
Top Feed Module —
PLACES Only

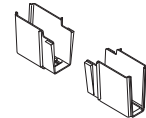

HCT-0000
Plastic Liner —
PLACES Only

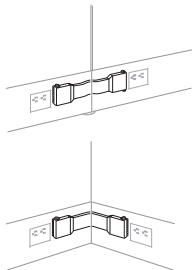

PCF-3-B
PCF-3-B2
PCF-3-B4
Flexible Power
Connector — Panel-to-
Panel — UniGroup Too,
UniGroup, PLACES

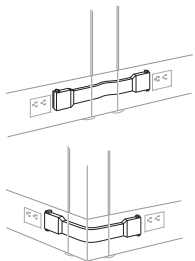

PCSS-3-B
PCSS-3-B2
PCSS-3-B4
Flexible Power
Connector — Straight
Span — UniGroup Too,
UniGroup, PLACES

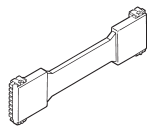

PCOF-1-B
PCOF-1-B2
PCOF-1-B4
Connector Assembly —
12" Pass-Through —
UniGroup Too, UniGroup,
PLACES

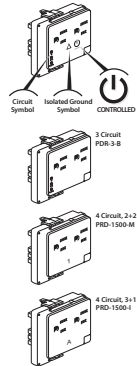

PRD-3-B
PRDI-5-B
PRD-1500-M
PRD-1500-I
Duplex Receptacles —
15 Amp — UniGroup Too,
UniGroup, PLACES

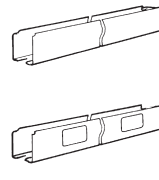

RKN-B
RKP-B2
RKP-B4
Raceway Retrofit Kit —
UniGroup Too, UniGroup,
PLACES

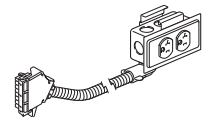

PRD-2000-M13
PRD-2000-M12
Duplex Receptacle —
20 Amp — UniGroup Too,
UniGroup, PLACES

Statement of Line

Electrical Components (cont'd) — pages 145-159

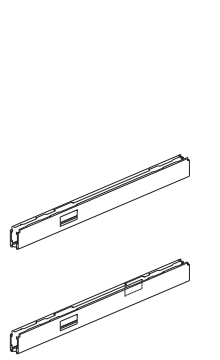

RKP-3-LS
RKP-3-LB
Raceway Cover – 20 Amp — UniGroup Too, UniGroup, PLACES

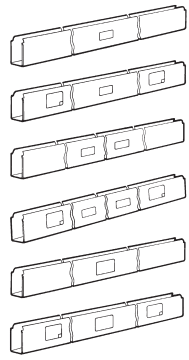

PRCN-B
PRCP-B
PRCN-B
PRCP-B
PRCN-B
PRCP-B
Ported Raceway Covers — UniGroup Too, UniGroup, PLACES



EC-10-B
Base Raceway End Cap — UniGroup Too, UniGroup, PLACES

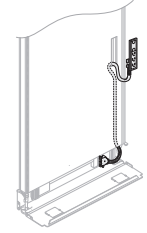

HPCA-3
HPCA-G3
HPCA-2
HPCA-G2
HPCA-4
HPCA-G4
Power/Communication Port Kit — UniGroup Too, UniGroup, PLACES

Electrical and Cable Management Accessories — pages 160-165

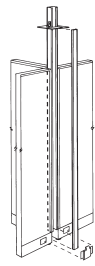

CMPF-1-BR
Cable Management Pole — One Channel – UniGroup Too and UniGroup Only



CMPT-1-B
Cable Management Pole — Two Channels – UniGroup Too and UniGroup Only

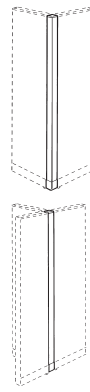

HCPA
HCPS
HCPE
Cable Management Pole – Panel Height – PLACES Only

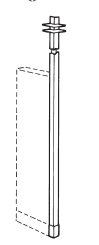
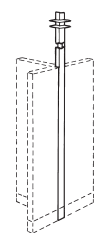
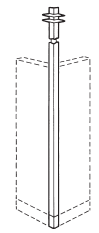

HCPA
HCPS
HCPE
Cable Management Pole – for 10'(3048mm)-High Ceiling — PLACES Only

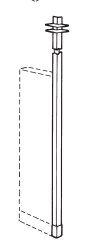
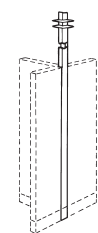
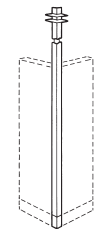

HCPA
HCPS
HCPE
Cable Management Pole – for 12'(3658mm)-High Ceiling – PLACES Only

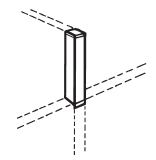

HSCP-F1
HSCP-V1
Cable Management Post – Variable Height – PLACES Only

Statement of Line

Electrical and Cable Management Accessories (cont'd) — pages 160-165

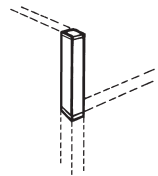

HSCP-F2
HSCP-V2
Cable Management Post – Variable Height – Two-Way 90° – PLACES Only

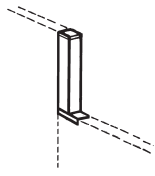

HSCP-F3
HSCP-V3
Cable Management Post – Variable Height – In-Line – PLACES Only

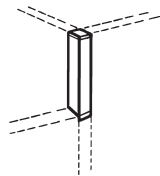

HCCP-F4
HCCP-V4
Cable Management Post – Variable Height – Three-Way 90° – PLACES Only

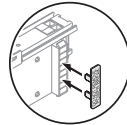

NEP-1
Power Breaker Marker – UniGroup Too, UniGroup, PLACES

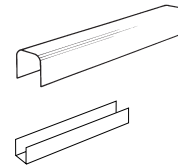

ETCR
Expanded Top Cap Raceway – UniGroup Only

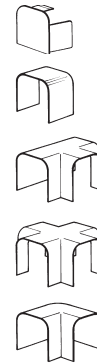

FC-1
FC-2
FC-3
FC-4
FC-90
Expanded Top Finish Cap – UniGroup Only

Electrical Components — Hardwire — UniGroup Too, UniGroup, PLACES — page 167

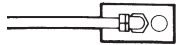

BFM-1-C
Base Feed Kit

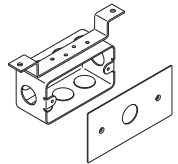

RKP-00-C
Dual Power Access Raceway Kit — 4"-High Base Raceway

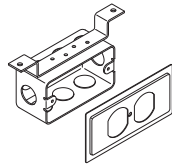

BPM-1-C
Blank Cover Plate

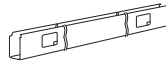

PRCP
Raceway Covers

Electrical Components — International — pages 168-170



E2FM-NT
Top Feed Module – Hardwire / International – UniGroup Too Only

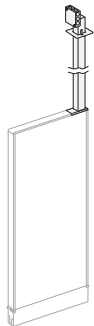

TFM-NT
Top Feed Module – Hardwire / International – UniGroup Only



HTFM
Top Feed Module – Hardwire / International – PLACES Only

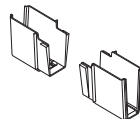

HCT-0000
Plastic Liner – PLACES Only



Power Entry Cord

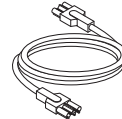

Cord

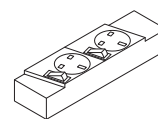











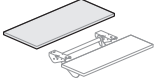
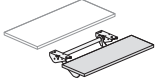





Receptacle

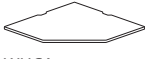

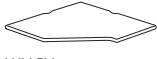

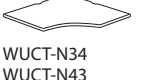
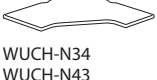
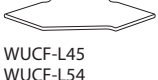
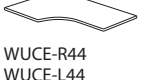
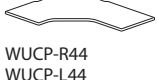
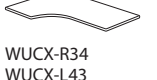
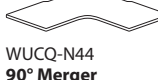

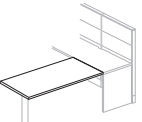
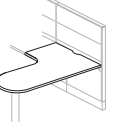
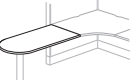

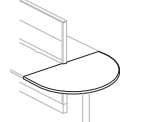
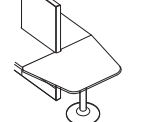
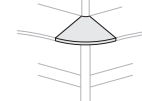

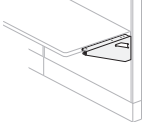

Splitter

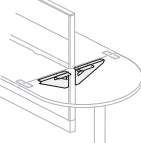
Statement of Line

Adaptable Worksurfaces — pages 171-211

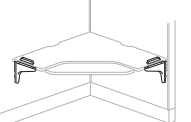
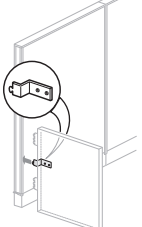
 WURA Rectangular	 WURA Rectangular	 WUKR Rectangular Adjustable Split Top	 WURY Rectangular Key	 WURS Rectangular Swell	 WURW Rectangular Inverse Swell	 WURT-N43 WURT-N34 Rectangular Transition	 WURE-N34 WURE-N43 Wedge	
 WURG-N34 WURG-N43 Sharp Wedge	 WURR Rectangular Radius Edge	 WUCA Corner, 90° Straight Front	 WUCR Corner, 90° Wrap- Around	 WUCN Corner, 90° Notched	 WUCU Corner, 90° Angled	 WUCN Corner 90° Worksurface	 WUKC Corner 90° Adjustable Split Top	
 WUCT-N34 WUCT-N43 Corner, 90° Wrap- Around Transitional	 WUCH-N34 WUCH-N43 Corner, 90° Notched Transitional	 WUCF-L45 WUCF-L54 Corner, 90° Angled - Transitional	 WUCE-R44 WUCE-L44 Corner, 90° Wrap- Around Extended	 WUCP-R44 WUCP-L44 Corner, 90° Notched Extended	 WUCX-R34 WUCX-L43 Corner, 90° Wrap- Around Transitional Extended	 WUCQ-N44 90° Merger	 WUCZ-N44 Corner, 120° Wrap-Around	
 WURD D-Shaped Convergent	 WURV Rectangular Convergent	 WUCD-L D-Shaped Convergent, Wrap-Around	 WUDD D-Shaped Ender	 WUCB-R45 WUCB-L54 Bent	 WUTS Countertop	 WUDC-3830 WUDC-5030 WUDC-6230 Conference End	 WURY-3830 WURY-5030 WURY-5036 WURY-6236 WURY-6242 WURY-6248 Key Conference End	 WUDZ 120° Link

Worksurface Supports — for use with UniGroup Too, UniGroup & PLACES — pages 212-216

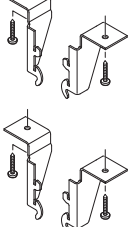
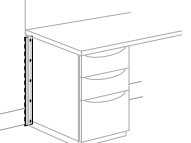
 ZEBD-1600 Standard Cantilever Bracket	 ZEBD-1000 Standard Mini Cantilever Bracket	 ZEBL-1600 Standard Link Cantilever Bracket	 ZESB-1900 Standard Snap-n-Fit Cantilever Bracket for Rectangular Worksurfaces	 ZESB-1200 Standard Snap-n-Fit Mini Cantilever Bracket for Rectangular Worksurfaces	 ZEBC-1900 Standard Snap-n-Fit Cantilever Bracket for Corner Worksurface	 ZEBC-1200 Standard Snap-n-Fit Mini Cantilever Bracket for Corner Worksurface
 ZEBF-0000-P Anti Dislodgement Bracket for use with Worksurface Support Panels	 ZEBB-0000 Side Bracket	 ZEBV-0000 Convergent Mount Bracket	 ZUBF-0000 Flush Mount Plate	 ZEBR-0000 Rear-Corner Bracket	 Z2BT-0000 ZEBT-0000 ZHBT-0000 Counter Top Brackets	 ZEBN-0000 Pedestal-to-Panel Bracket

Statement of Line

Worksurface Supports — pages 217-219

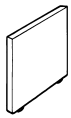

ZEFS
Worksurface
Support Panels



WUCL-0001
Straight Leg Basic

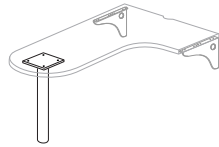

WUCC-0004
Support Column

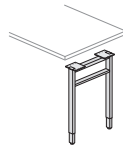

ZZFK
Double Support Leg

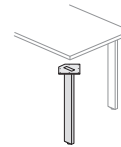

ZUFJ-0101-PNFG
Single Support Leg

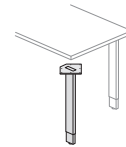

ZZFJ
Support Post

Worksurface Accessories — page 220

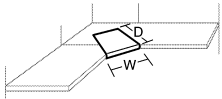

MAC-0001
Make-A-Corner

Adaptable Upper Storage — page 221

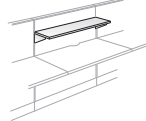

UESY-PM
Straight Mini Shelf,
Standard Mount —
for use with
UniGroup Too,
UniGroup, PLACES

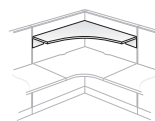

UESZ-PM
Corner Mini Shelf,
Standard Mount —
for use with
UniGroup Too,
UniGroup, PLACES

Mini Shelves with Loop Bracket — page 222



HMSS
Straight Mini-Shelf,
with Loop Bracket —
for use with
UniGroup Too,
UniGroup, PLACES

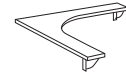

HMSC
Corner Mini-Shelf,
with Loop Bracket —
for use with
UniGroup Too,
UniGroup, PLACES

Adaptable Upper Storage — for use with UniGroup Too, UniGroup, PLACES — pages 223-231

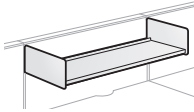

UESN-PM
Open Shelf,
Standard Mount



NUB-1
Overhead Storage
Unit / Shelf Gang Clip

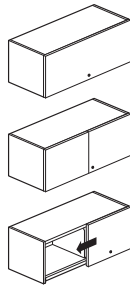

UEFS-PM
UEKS-PM
UEHS-PM
Overhead Storage Unit,
Standard Mount —
Painted Door

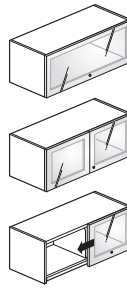

UEFF-QM
UEKF-QM
UEHF-QM
Overhead Storage Unit,
Standard Mount —
Translucent Door

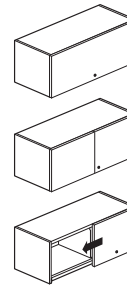

UEFS-WM
UEKS-WM
UEHS-WM
Overhead Storage Unit,
Standard Mount —
Wood Door

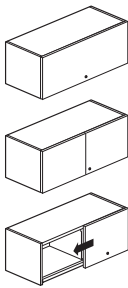

UEFS-LM
UEKS-LM
UEHS-LM
Overhead Storage Unit,
Standard Mount —
Laminate Door

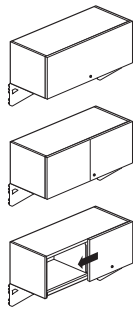

UEGS-PM
UELS-PM
UEJS-PM
Overhead Storage
Unit, Up Mount —
Painted Door

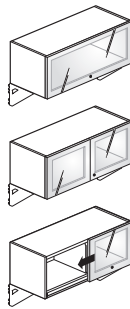

UEGF-QM
UELF-QM
UEJF-QM
Overhead Storage
Unit, Up Mount —
Translucent Door

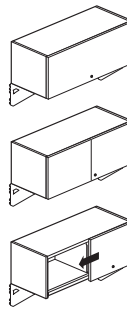

UEGS-WM
UELS-WM
UEJS-WM
Overhead Storage
Unit, Up Mount —
Wood Door

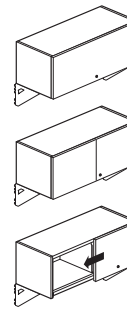

UEGS-LM
UELS-LM
UEJS-LM
Overhead Storage
Unit, Up Mount —
Laminate Door

Statement of Line

Wall Mount Components — for use with UniGroup Too, UniGroup, PLACES — pages 232-235

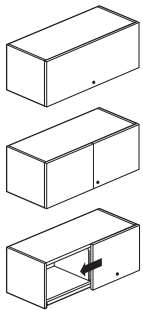

UUFS-PW
UUKS-PW
UUHS-PW
**Overhead Storage Unit,
Wall Mount – Painted Door**

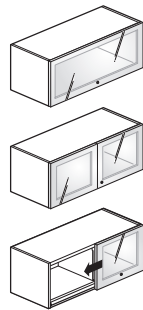

UUFF-QW
UUKF-QW
UUHF-QW
**Overhead Storage Unit,
Wall Mount – Translucent
Door**

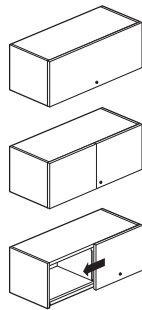

UUFS-WW
UUKS-WW
UUHS-WW
**Overhead Storage Unit,
Wall Mount – Wood Door**

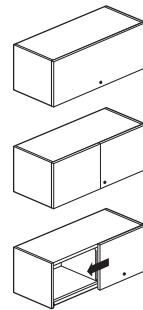

UUFS-LW
UUKS-LW
UUHS-LW
**Overhead Storage Unit,
Wall Mount – Laminate
Door**

Shelf Accessories — page 236

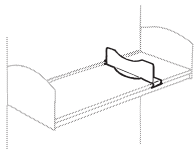

NADR-8
Adaptable Shelf Dividers

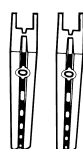

WT
Wall Track

Wall Mount Components — pages 237-238

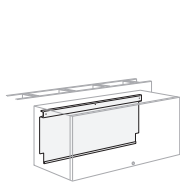

UUFB-P
**Back for Wall Mounted
Overhead Storage Unit**

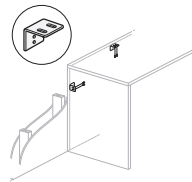

ZUBW-PN
**Worksurface
Wall Bracket**



KUAF
**Tackboard,
Wall Mount**



KUAM
**Markerboard,
Wall Mount**

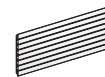

KUPY
**Slat,
Wall Mount**

Tack Strips/Tackboards — pages 239-240



HTB
Tack Strip



HTB
Tackboard



HTB-H
**Tack Strip — Monolithic
High- Performance
Acoustical Panels**



HTB-H
**Tackboard — Monolithic
High- Performance
Acoustical Panels**

Markerboards/Wall Accessory Slat Pad — for use with UniGroup Too, UniGroup, PLACES — page 241

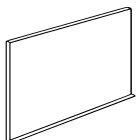

MEAM
HNAM
**Markerboard —
Non-Magnetic Surface**



HGRY
Wall Accessory Slat Pad

Statement of Line

Markerboards Accessories — page 242



7062-8001



7031-7002



7031-7001

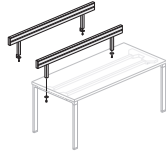

KUR1-1224-CSN
**Tool Rail — Worksurface Mount
C-Clamp or Thru-Mount**

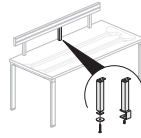

KUP1-0000-CSN
**Tool Rail — Single Post —
C-Clamp or Thru-mount**

Lighting — Task — pages 245-246

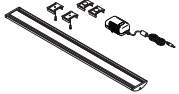

LUTS-0017-19ULD5
**Reed Premier™
Stand-Alone LED Task Light**

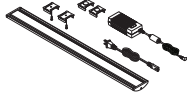

LUTS-0017-12ULD6
**Reed Premier™
Starter LED Task Light**



LUTD-0017-1NULDN
**Reed Premier™
Add-On LED Task Light —
For Use with Reed Premier
Starter LED Task Lights**

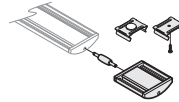

LUTS-0000
**Reed Premier™
Add-On Occupancy Sensor**

Lighting — Haworth — pages 247-248

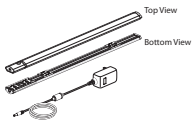

LUTN
**Adaptable LED Task
Light - Stand-Alone**

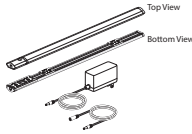

LUTT
**Adaptable LED Task
Light - Starter Kit**



LUTA
**Adaptable LED Task
Light - Add-On Kit**

Basic Monolithic Panel — No Power

UniGroup Too

Fabric

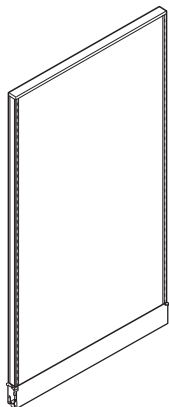

E2MN-B (Non-Powered)

NOTE:

This panel has fabric/colorway restrictions, see systems fabrics/ color legend.

Features

- Includes non-powered panel assembly, square top cap with aligner, with or without one-piece base raceway cover, 1.6 hinge kits, side trim rails, leveling glides and carpet gripper. .6 top cap end plugs and base raceway end caps are shipped with each panel. Order additional as necessary.
- Acoustical panel surfaces over 0.125"(3mm) thick fiber board.
- Panel surfaces may have the same fabric on both sides or a different fabric on each side.
- Panel thickness is 2"(51mm).
- Base raceway is 4"(102mm) high.
- Shipped with unassembled top cap, base raceway cover and side trim rails.

Specification Tips

- Panels will accept add-on panels up to a combined height of 80"(2032mm). For aesthetic consistency, specify UniGroup Too add-on panels.
- Raceway cover must be separately specified for option -BE (no raceway cover).
- If 90° top cap for four-way and 120° top cap for three-way are not specified, additional top cap end plugs will need to be ordered.
- Additional top cap end plugs and base raceway end caps will need to be specified if finish posts are not ordered.

To Order, Specify:

- 1) Product number, including:

① Options:

B With Raceway Cover

BE Without Raceway Cover, deduct **\$122.58** list

- 2) Fabric/colorway for panel side one.
- 3) Fabric/colorway for panel side two.
- 4) Trim color raceway cover, glide housings and end caps.
- 5) Trim color for top cap and side trim rails.

Note: Upcharge for mixed surface grades, refer to the electronic design and specification tools for pricing.

NOTES:

- Non-powered panels ship without receptacle ports in the base raceway cover.
- Some building codes may restrict the use of panel heights greater than 69"(1753mm). Consult your local code authority to assure that the furniture layout is compliant.
- For International Power, specify non-powered panels and use Power Logic components. See Specification Guide for more information on Power Logic.
- For Chicago power, specify non-powered panels without a base raceway cover and separately specify Chicago power retrofit kit.

Basic Monolithic Panel — No Power

UniGroup Too

Fabric	Actual Height	Width	Number ①	Trim A Fabric Grade					
				A	B	C	E	F	G
32"(813mm)	24"(610mm)	E2MN-230-	■ ■	\$ 886.33	\$1002.49	\$1130.33	\$1409.19	\$1595.07	\$1711.17
	30"(762mm)	E2MN-3030-	■ ■	944.11	1063.87	1198.91	1499.37	1699.65	1819.35
	36"(914mm)	E2MN-330-	■ ■	1001.89	1125.25	1267.49	1589.55	1804.23	1927.53
	42"(1067mm)	E2MN-4230-	■ ■	1059.67	1186.63	1336.07	1679.73	1908.81	2035.71
	48"(1219mm)	E2MN-430-	■ ■	1117.45	1248.01	1404.65	1769.91	2013.39	2143.89
	60"(1524mm)	E2MN-530-	■ ■	1233.01	1370.77	1541.81	1950.27	2222.55	2360.25
40"(1016mm)	24"(610mm)	E2MN-238-	■ ■	\$ 959.61	\$1079.61	\$1215.13	\$1517.03	\$1718.27	\$1838.21
	30"(762mm)	E2MN-3038-	■ ■	1030.83	1155.39	1300.03	1629.29	1848.77	1973.27
	36"(914mm)	E2MN-338-	■ ■	1102.05	1231.17	1384.93	1741.55	1979.27	2108.33
	42"(1067mm)	E2MN-4238-	■ ■	1173.27	1306.95	1469.83	1853.81	2109.77	2243.39
	48"(1219mm)	E2MN-438-	■ ■	1244.49	1382.73	1554.73	1966.07	2240.27	2378.45
	60"(1524mm)	E2MN-538-	■ ■	1386.93	1534.29	1724.53	2190.59	2501.27	2648.57
48"(1219mm)	24"(610mm)	E2MN-246-	■ ■	\$1032.89	\$1156.73	\$1299.93	\$1624.87	\$1841.47	\$1965.25
	30"(762mm)	E2MN-3046-	■ ■	1117.55	1246.91	1401.15	1759.21	1997.89	2127.19
	36"(914mm)	E2MN-346-	■ ■	1202.21	1337.09	1502.37	1893.55	2154.31	2289.13
	42"(1067mm)	E2MN-4246-	■ ■	1286.87	1427.27	1603.59	2027.89	2310.73	2451.07
	48"(1219mm)	E2MN-446-	■ ■	1371.53	1517.45	1704.81	2162.23	2467.15	2613.01
	60"(1524mm)	E2MN-546-	■ ■	1540.85	1697.81	1907.25	2430.91	2779.99	2936.89
56"(1422mm)	24"(610mm)	E2MN-254-	■ ■	\$1106.17	\$1233.85	\$1384.73	\$1732.71	\$1964.67	\$2092.29
	30"(762mm)	E2MN-3054-	■ ■	1204.27	1338.43	1502.27	1889.13	2147.01	2281.11
	36"(914mm)	E2MN-354-	■ ■	1302.37	1443.01	1619.81	2045.55	2329.35	2469.93
	42"(1067mm)	E2MN-4254-	■ ■	1400.47	1547.59	1737.35	2201.97	2511.69	2658.75
	48"(1219mm)	E2MN-454-	■ ■	1498.57	1652.17	1854.89	2358.39	2694.03	2847.57
	60"(1524mm)	E2MN-554-	■ ■	1694.77	1861.33	2089.97	2671.23	3058.71	3225.21
64"(1626mm)	24"(610mm)	E2MN-262-	■ ■	\$1179.45	\$1310.97	\$1469.53	\$1840.55	\$2087.87	\$2219.33
	30"(762mm)	E2MN-3062-	■ ■	1290.99	1429.95	1603.39	2019.05	2296.13	2435.03
	36"(914mm)	E2MN-362-	■ ■	1402.53	1548.93	1737.25	2197.55	2504.39	2650.73
	42"(1067mm)	E2MN-4262-	■ ■	1514.07	1667.91	1871.11	2376.05	2712.65	2866.43
	48"(1219mm)	E2MN-462-	■ ■	1625.61	1786.89	2004.97	2554.55	2920.91	3082.13
	60"(1524mm)	E2MN-562-	■ ■	1848.69	2024.85	2272.69	2911.55	3337.43	3513.53
72"(1829mm)	24"(610mm)	E2MN-270-	■ ■	\$1252.73	\$1388.09	\$1554.33	\$1948.39	\$2211.07	\$2346.37
	30"(762mm)	E2MN-3070-	■ ■	1377.71	1521.47	1704.51	2148.97	2445.25	2588.95
	36"(914mm)	E2MN-370-	■ ■	1502.69	1654.85	1854.69	2349.55	2679.43	2831.53
	42"(1067mm)	E2MN-4270-	■ ■	1627.67	1788.23	2004.87	2550.13	2913.61	3074.11
	48"(1219mm)	E2MN-470-	■ ■	1752.65	1921.61	2155.05	2750.71	3147.79	3316.69
	60"(1524mm)	E2MN-570-	■ ■	2002.61	2188.37	2455.41	3151.87	3616.15	3801.85
80"(2032mm)	24"(610mm)	E2MN-278-	■ ■	\$1326.01	\$1465.21	\$1639.13	\$2056.23	\$2334.27	\$2473.41
	30"(762mm)	E2MN-3078-	■ ■	1464.43	1612.99	1805.63	2278.89	2594.37	2742.87
	36"(914mm)	E2MN-378-	■ ■	1602.85	1760.77	1972.13	2501.55	2854.47	3012.33
	42"(1067mm)	E2MN-4278-	■ ■	1741.27	1908.55	2138.63	2724.21	3114.57	3281.79
	48"(1219mm)	E2MN-478-	■ ■	1879.69	2056.33	2305.13	2946.87	3374.67	3551.25
	60"(1524mm)	E2MN-578-	■ ■	2156.53	2351.89	2638.13	3392.19	3894.87	4090.17

Basic Monolithic Panel — No Power

UniGroup Too

Fabric	Actual Height	Width	Number ①	Trim B Fabric Grade		C	E	F	G
				A	B				
32"(813mm)	24"(610mm)	E2MN-230-	■ ■	\$ 919.19	\$1035.35	\$1163.19	\$1442.05	\$1627.93	\$1744.03
	30"(762mm)	E2MN-3030-	■ ■	978.05	1097.81	1232.85	1533.31	1733.59	1853.29
	36"(914mm)	E2MN-330-	■ ■	1036.91	1160.27	1302.51	1624.57	1839.25	1962.55
	42"(1067mm)	E2MN-4230-	■ ■	1095.77	1222.73	1372.17	1715.83	1944.91	2071.81
	48"(1219mm)	E2MN-430-	■ ■	1154.63	1285.19	1441.83	1807.09	2050.57	2181.07
	60"(1524mm)	E2MN-530-	■ ■	1272.35	1410.11	1581.15	1989.61	2261.89	2399.59
40"(1016mm)	24"(610mm)	E2MN-238-	■ ■	\$ 993.59	\$1113.59	\$1249.11	\$1551.01	\$1752.25	\$1872.19
	30"(762mm)	E2MN-3038-	■ ■	1065.89	1190.45	1335.09	1664.35	1883.83	2008.33
	36"(914mm)	E2MN-338-	■ ■	1138.19	1267.31	1421.07	1777.69	2015.41	2144.47
	42"(1067mm)	E2MN-4238-	■ ■	1210.49	1344.17	1507.05	1891.03	2146.99	2280.61
	48"(1219mm)	E2MN-438-	■ ■	1282.79	1421.03	1593.03	2004.37	2278.57	2416.75
	60"(1524mm)	E2MN-538-	■ ■	1427.39	1574.75	1764.99	2231.05	2541.73	2689.03
48"(1219mm)	24"(610mm)	E2MN-246-	■ ■	\$1067.99	\$1191.83	\$1335.03	\$1659.97	\$1876.57	\$2000.35
	30"(762mm)	E2MN-3046-	■ ■	1153.73	1283.09	1437.33	1795.39	2034.07	2163.37
	36"(914mm)	E2MN-346-	■ ■	1239.47	1374.35	1539.63	1930.81	2191.57	2326.39
	42"(1067mm)	E2MN-4246-	■ ■	1325.21	1465.61	1641.93	2066.23	2349.07	2489.41
	48"(1219mm)	E2MN-446-	■ ■	1410.95	1556.87	1744.23	2201.65	2506.57	2652.43
	60"(1524mm)	E2MN-546-	■ ■	1582.43	1739.39	1948.83	2472.49	2821.57	2978.47
56"(1422mm)	24"(610mm)	E2MN-254-	■ ■	\$1142.39	\$1270.07	\$1420.95	\$1768.93	\$2000.89	\$2128.51
	30"(762mm)	E2MN-3054-	■ ■	1241.57	1375.73	1539.57	1926.43	2184.31	2318.41
	36"(914mm)	E2MN-354-	■ ■	1340.75	1481.39	1658.19	2083.93	2367.73	2508.31
	42"(1067mm)	E2MN-4254-	■ ■	1439.93	1587.05	1776.81	2241.43	2551.15	2698.21
	48"(1219mm)	E2MN-454-	■ ■	1539.11	1692.71	1895.43	2398.93	2734.57	2888.11
	60"(1524mm)	E2MN-554-	■ ■	1737.47	1904.03	2132.67	2713.93	3101.41	3267.91
64"(1626mm)	24"(610mm)	E2MN-262-	■ ■	\$1216.79	\$1348.31	\$1506.87	\$1877.89	\$2125.21	\$2256.67
	30"(762mm)	E2MN-3062-	■ ■	1329.41	1468.37	1641.81	2057.47	2334.55	2473.45
	36"(914mm)	E2MN-362-	■ ■	1442.03	1588.43	1776.75	2237.05	2543.89	2690.23
	42"(1067mm)	E2MN-4262-	■ ■	1554.65	1708.49	1911.69	2416.63	2753.23	2907.01
	48"(1219mm)	E2MN-462-	■ ■	1667.27	1828.55	2046.63	2596.21	2962.57	3123.79
	60"(1524mm)	E2MN-562-	■ ■	1892.51	2068.67	2316.51	2955.37	3381.25	3557.35
72"(1829mm)	24"(610mm)	E2MN-270-	■ ■	\$1291.19	\$1426.55	\$1592.79	\$1986.85	\$2249.53	\$2384.83
	30"(762mm)	E2MN-3070-	■ ■	1417.25	1561.01	1744.05	2188.51	2484.79	2628.49
	36"(914mm)	E2MN-370-	■ ■	1543.31	1695.47	1895.31	2390.17	2720.05	2872.15
	42"(1067mm)	E2MN-4270-	■ ■	1669.37	1829.93	2046.57	2591.83	2955.31	3115.81
	48"(1219mm)	E2MN-470-	■ ■	1795.43	1964.39	2197.83	2793.49	3190.57	3359.47
	60"(1524mm)	E2MN-570-	■ ■	2047.55	2233.31	2500.35	3196.81	3661.09	3846.79
80"(2032mm)	24"(610mm)	E2MN-278-	■ ■	\$1365.59	\$1504.79	\$1678.71	\$2095.81	\$2373.85	\$2512.99
	30"(762mm)	E2MN-3078-	■ ■	1505.09	1653.65	1846.29	2319.55	2635.03	2783.53
	36"(914mm)	E2MN-378-	■ ■	1644.59	1802.51	2013.87	2543.29	2896.21	3054.07
	42"(1067mm)	E2MN-4278-	■ ■	1784.09	1951.37	2181.45	2767.03	3157.39	3324.61
	48"(1219mm)	E2MN-478-	■ ■	1923.59	2100.23	2349.03	2990.77	3418.57	3595.15
	60"(1524mm)	E2MN-578-	■ ■	2202.59	2397.95	2684.19	3438.25	3940.93	4136.23

This page intentionally blank

Basic Monolithic Panel — Powered

UniGroup Too

Fabric

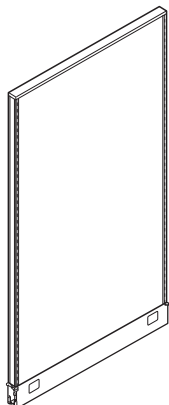

E2MP-B (3-circuit)
E2MP-2 (4-circuit, 2+2)
E2MP-4 (4-circuit, 3+1)



NOTE:

This panel has fabric/colorway restrictions, see systems fabrics/ color legend.

Features

- Includes powered panel assembly, square top cap with aligner, with or without one-piece base raceway cover, 1.6 hinge kits, side trim rails, leveling glides and carpet gripper; power distribution assembly/flex connector(s). .6 top cap end plugs and base raceway end caps are shipped with each panel. Order additional as necessary.
- Acoustical fabric surface over 0.125"(3mm) thick fiber board.
- Panel surfaces may have the same fabric on both sides or a different fabric on each side.
- Panel thickness is 2"(51mm).
- Base raceway is 4"(102mm) high.
- Powered raceway with or without raceway cover requires modified catalog number and list price.
- Powered panels are available for countries that utilize 120 volt 60 hertz electrical systems and U.S. configured plugs and outlets.
- Shipped with unassembled top cap, base raceway cover and side trim rails.

Specification Tips

- Panels will accept add-on panels up to a combined height of 80"(2032mm). For aesthetic consistency, specify UniGroup Too add-on panels.
- Flex connectors provided for powered monolithic panels accommodate straight in-line, inside 90°, and inside 120° conditions (if applicable).
- Receptacles for powered panels must be specified separately.
- Raceway cover must be separately specified for option -BE, BYE, 2E, 2YE, 4E or 4YE (no raceway cover).
- If 90° top cap for four-way and 120° top cap for three-way are not specified, additional top cap end plugs will need to be ordered.
- Additional top cap end plugs and base raceway end caps will need to be specified if finish posts are not ordered.

To Order, Specify:

- Product number, including:

1 3-Circuit

- B** With Raceway Cover
- BE** Without Raceway Cover, deduct **\$138.36** list
- BY** NYC with Raceway Cover
- BYE** NYC without Raceway Cover, deduct **\$138.36** list

4-Circuit, 2+2

- 2** With Raceway Cover, add **\$46.18** list
- 2E** Without Raceway Cover, deduct **\$92.18** list
- 2Y** NYC with Raceway Cover, add **\$46.18** list
- 2YE** NYC without Raceway Cover, deduct **\$92.18** list

4-Circuit, 3+1

- 4** With Raceway Cover, add **\$46.18** list
- 4E** Without Raceway Cover, deduct **\$92.18** list
- 4Y** NYC with Raceway Cover, add **\$46.18** list
- 4YE** NYC without Raceway Cover, deduct **\$92.18** list

- Fabric/colorway for panel side one.
- Fabric/colorway for panel side two.
- Trim color raceway cover, glide housings and end caps.
- Trim color for top cap and side trim rails.

Note: Upcharge for mixed surface grades, refer to the electronic design and specification tools for pricing.

NOTES:

- Powered panels with raceway covers ship with receptacle ports in the base raceway cover. Receptacle ports on the raceway cover measure 2.35"(60mm) top-to-bottom and 2.88"(73mm) side-to-side.
- Powered panels with Power Distribution Assemblies (PDA) but without raceway covers require separately specified base raceway covers for power and communication port locations other than the standard powered base raceway cover.
- New York City (NYC) electrical applications require field installation of PDA.
- New York Port Authority (NYPA) electrical applications require metal raceway covers. To order, specify NYC powered panels without raceway cover and separately specify metal covers through Haworth e-Parts.
- Some building codes may restrict the use of panel heights greater than 69"(1753mm). Consult your local code authority to assure that the furniture layout is compliant.
- For International Power, specify non-powered panels and use Power Logic components. See Specification Guide for more information on Power Logic.
- For Chicago power, specify non-powered panels without a base raceway cover and separately specify Chicago power retrofit kit.

Basic Monolithic Panel — Powered

UniGroup Too

Fabric	Actual Height	Width	Number ①	Trim A Fabric Grade					
				A	B	C	E	F	G
32"(813mm)	24"(610mm)	E2MP-230-		\$1337.37	\$1453.53	\$1581.37	\$1860.23	\$2046.11	\$2162.21
	30"(762mm)	E2MP-3030-		1395.15	1514.91	1649.95	1950.41	2150.69	2270.39
	36"(914mm)	E2MP-330-		1452.93	1576.29	1718.53	2040.59	2255.27	2378.57
	42"(1067mm)	E2MP-4230-		1510.71	1637.67	1787.11	2130.77	2359.85	2486.75
	48"(1219mm)	E2MP-430-		1568.49	1699.05	1855.69	2220.95	2464.43	2594.93
	60"(1524mm)	E2MP-530-		1684.05	1821.81	1992.85	2401.31	2673.59	2811.29
40"(1016mm)	24"(610mm)	E2MP-238-		\$1410.65	\$1530.65	\$1666.17	\$1968.07	\$2169.31	\$2289.25
	30"(762mm)	E2MP-3038-		1481.87	1606.43	1751.07	2080.33	2299.81	2424.31
	36"(914mm)	E2MP-338-		1553.09	1682.21	1835.97	2192.59	2430.31	2559.37
	42"(1067mm)	E2MP-4238-		1624.31	1757.99	1920.87	2304.85	2560.81	2694.43
	48"(1219mm)	E2MP-438-		1695.53	1833.77	2005.77	2417.11	2691.31	2829.49
	60"(1524mm)	E2MP-538-		1837.97	1985.33	2175.57	2641.63	2952.31	3099.61
48"(1219mm)	24"(610mm)	E2MP-246-		\$1483.93	\$1607.77	\$1750.97	\$2075.91	\$2292.51	\$2416.29
	30"(762mm)	E2MP-3046-		1568.59	1697.95	1852.19	2210.25	2448.93	2578.23
	36"(914mm)	E2MP-346-		1653.25	1788.13	1953.41	2344.59	2605.35	2740.17
	42"(1067mm)	E2MP-4246-		1737.91	1878.31	2054.63	2478.93	2761.77	2902.11
	48"(1219mm)	E2MP-446-		1822.57	1968.49	2155.85	2613.27	2918.19	3064.05
	60"(1524mm)	E2MP-546-		1991.89	2148.85	2358.29	2881.95	3231.03	3387.93
56"(1422mm)	24"(610mm)	E2MP-254-		\$1557.21	\$1684.89	\$1835.77	\$2183.75	\$2415.71	\$2543.33
	30"(762mm)	E2MP-3054-		1655.31	1789.47	1953.31	2340.17	2598.05	2732.15
	36"(914mm)	E2MP-354-		1753.41	1894.05	2070.85	2496.59	2780.39	2920.97
	42"(1067mm)	E2MP-4254-		1851.51	1998.63	2188.39	2653.01	2962.73	3109.79
	48"(1219mm)	E2MP-454-		1949.61	2103.21	2305.93	2809.43	3145.07	3298.61
	60"(1524mm)	E2MP-554-		2145.81	2312.37	2541.01	3122.27	3509.75	3676.25
64"(1626mm)	24"(610mm)	E2MP-262-		\$1630.49	\$1762.01	\$1920.57	\$2291.59	\$2538.91	\$2670.37
	30"(762mm)	E2MP-3062-		1742.03	1880.99	2054.43	2470.09	2747.17	2886.07
	36"(914mm)	E2MP-362-		1853.57	1999.97	2188.29	2648.59	2955.43	3101.77
	42"(1067mm)	E2MP-4262-		1965.11	2118.95	2322.15	2827.09	3163.69	3317.47
	48"(1219mm)	E2MP-462-		2076.65	2237.93	2456.01	3005.59	3371.95	3533.17
	60"(1524mm)	E2MP-562-		2299.73	2475.89	2723.73	3362.59	3788.47	3964.57
72"(1829mm)	24"(610mm)	E2MP-270-		\$1703.77	\$1839.13	\$2005.37	\$2399.43	\$2662.11	\$2797.41
	30"(762mm)	E2MP-3070-		1828.75	1972.51	2155.55	2600.01	2896.29	3039.99
	36"(914mm)	E2MP-370-		1953.73	2105.89	2305.73	2800.59	3130.47	3282.57
	42"(1067mm)	E2MP-4270-		2078.71	2239.27	2455.91	3001.17	3364.65	3525.15
	48"(1219mm)	E2MP-470-		2203.69	2372.65	2606.09	3201.75	3598.83	3767.73
	60"(1524mm)	E2MP-570-		2453.65	2639.41	2906.45	3602.91	4067.19	4252.89
80"(2032mm)	24"(610mm)	E2MP-278-		\$1777.05	\$1916.25	\$2090.17	\$2507.27	\$2785.31	\$2924.45
	30"(762mm)	E2MP-3078-		1915.47	2064.03	2256.67	2729.93	3045.41	3193.91
	36"(914mm)	E2MP-378-		2053.89	2211.81	2423.17	2952.59	3305.51	3463.37
	42"(1067mm)	E2MP-4278-		2192.31	2359.59	2589.67	3175.25	3565.61	3732.83
	48"(1219mm)	E2MP-478-		2330.73	2507.37	2756.17	3397.91	3825.71	4002.29
	60"(1524mm)	E2MP-578-		2607.57	2802.93	3089.17	3843.23	4345.91	4541.21

Basic Monolithic Panel — Powered

UniGroup Too

Fabric	Actual Height	Width	Number ①	Trim B		C	E	F	G
				Fabric Grade A	B				
32"(813mm)	24"(610mm)	E2MP-230-		\$1508.59	\$1624.75	\$1752.59	\$2031.45	\$2217.33	\$2333.43
	30"(762mm)	E2MP-3030-		1567.45	1687.21	1822.25	2122.71	2322.99	2442.69
	36"(914mm)	E2MP-330-		1626.31	1749.67	1891.91	2213.97	2428.65	2551.95
	42"(1067mm)	E2MP-4230-		1685.17	1812.13	1961.57	2305.23	2534.31	2661.21
	48"(1219mm)	E2MP-430-		1744.03	1874.59	2031.23	2396.49	2639.97	2770.47
	60"(1524mm)	E2MP-530-		1861.75	1999.51	2170.55	2579.01	2851.29	2988.99
40"(1016mm)	24"(610mm)	E2MP-238-		\$1582.99	\$1702.99	\$1838.51	\$2140.41	\$2341.65	\$2461.59
	30"(762mm)	E2MP-3038-		1655.29	1779.85	1924.49	2253.75	2473.23	2597.73
	36"(914mm)	E2MP-338-		1727.59	1856.71	2010.47	2367.09	2604.81	2733.87
	42"(1067mm)	E2MP-4238-		1799.89	1933.57	2096.45	2480.43	2736.39	2870.01
	48"(1219mm)	E2MP-438-		1872.19	2010.43	2182.43	2593.77	2867.97	3006.15
	60"(1524mm)	E2MP-538-		2016.79	2164.15	2354.39	2820.45	3131.13	3278.43
48"(1219mm)	24"(610mm)	E2MP-246-		\$1657.39	\$1781.23	\$1924.43	\$2249.37	\$2465.97	\$2589.75
	30"(762mm)	E2MP-3046-		1743.13	1872.49	2026.73	2384.79	2623.47	2752.77
	36"(914mm)	E2MP-346-		1828.87	1963.75	2129.03	2520.21	2780.97	2915.79
	42"(1067mm)	E2MP-4246-		1914.61	2055.01	2231.33	2655.63	2938.47	3078.81
	48"(1219mm)	E2MP-446-		2000.35	2146.27	2333.63	2791.05	3095.97	3241.83
	60"(1524mm)	E2MP-546-		2171.83	2328.79	2538.23	3061.89	3410.97	3567.87
56"(1422mm)	24"(610mm)	E2MP-254-		\$1731.79	\$1859.47	\$2010.35	\$2358.33	\$2590.29	\$2717.91
	30"(762mm)	E2MP-3054-		1830.97	1965.13	2128.97	2515.83	2773.71	2907.81
	36"(914mm)	E2MP-354-		1930.15	2070.79	2247.59	2673.33	2957.13	3097.71
	42"(1067mm)	E2MP-4254-		2029.33	2176.45	2366.21	2830.83	3140.55	3287.61
	48"(1219mm)	E2MP-454-		2128.51	2282.11	2484.83	2988.33	3323.97	3477.51
	60"(1524mm)	E2MP-554-		2326.87	2493.43	2722.07	3303.33	3690.81	3857.31
64"(1626mm)	24"(610mm)	E2MP-262-		\$1806.19	\$1937.71	\$2096.27	\$2467.29	\$2714.61	\$2846.07
	30"(762mm)	E2MP-3062-		1918.81	2057.77	2231.21	2646.87	2923.95	3062.85
	36"(914mm)	E2MP-362-		2031.43	2177.83	2366.15	2826.45	3133.29	3279.63
	42"(1067mm)	E2MP-4262-		2144.05	2297.89	2501.09	3006.03	3342.63	3496.41
	48"(1219mm)	E2MP-462-		2256.67	2417.95	2636.03	3185.61	3551.97	3713.19
	60"(1524mm)	E2MP-562-		2481.91	2658.07	2905.91	3544.77	3970.65	4146.75
72"(1829mm)	24"(610mm)	E2MP-270-		\$1880.59	\$2015.95	\$2182.19	\$2576.25	\$2838.93	\$2974.23
	30"(762mm)	E2MP-3070-		2006.65	2150.41	2333.45	2777.91	3074.19	3217.89
	36"(914mm)	E2MP-370-		2132.71	2284.87	2484.71	2979.57	3309.45	3461.55
	42"(1067mm)	E2MP-4270-		2258.77	2419.33	2635.97	3181.23	3544.71	3705.21
	48"(1219mm)	E2MP-470-		2384.83	2553.79	2787.23	3382.89	3779.97	3948.87
	60"(1524mm)	E2MP-570-		2636.95	2822.71	3089.75	3786.21	4250.49	4436.19
80"(2032mm)	24"(610mm)	E2MP-278-		\$1954.99	\$2094.19	\$2268.11	\$2685.21	\$2963.25	\$3102.39
	30"(762mm)	E2MP-3078-		2094.49	2243.05	2435.69	2908.95	3224.43	3372.93
	36"(914mm)	E2MP-378-		2233.99	2391.91	2603.27	3132.69	3485.61	3643.47
	42"(1067mm)	E2MP-4278-		2373.49	2540.77	2770.85	3356.43	3746.79	3914.01
	48"(1219mm)	E2MP-478-		2512.99	2689.63	2938.43	3580.17	4007.97	4184.55
	60"(1524mm)	E2MP-578-		2791.99	2987.35	3273.59	4027.65	4530.33	4725.63

Laminate Monolithic Panel — No Power

UniGroup Too

Laminate

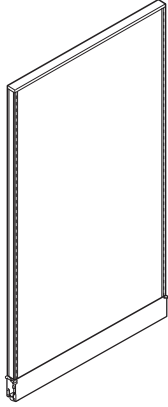

E2DN-B (Non-Powered)

Features

- Includes non-powered panel assembly, square top cap with aligner, with or without one-piece base raceway cover, 1.6 hinge kits, side trim rails, leveling glides and carpet gripper. .6 top cap end plugs and base raceway end caps are shipped with each panel. Order additional as necessary.
- Panel surfaces may have the same laminate surface color on both sides or a different laminate surface color on each side.
- Panel thickness is 2"(51mm).
- Base raceway is 4"(102mm) high.
- Shipped with unassembled top cap, base raceway cover and side trim rails.

Specification Tips

- Both sides in the same color laminate or different color laminate on each side.
- Panels will accept add-on panels up to a combined height of 80"(2032mm). For aesthetic consistency, specify UniGroup Too add-on panels.
- Raceway cover must be separately specified for option -BE (no raceway cover).
- If 90° top cap for four-way and 120° top cap for three-way are not specified, additional top cap end plugs will need to be ordered.
- Additional top cap end plugs and base raceway end caps will need to be specified if finish posts are not ordered.

To Order, Specify:

- 1) Product number, including:

① Options:

B With Raceway Cover

BE Without Raceway Cover, deduct **\$122.58** list

- 2) Laminate surface color for panel side one.
- 3) Laminate surface color for panel side two.
- 4) Trim color raceway cover, glides, end caps and end caps.
- 5) Trim color for top cap and side trim rails.

Note: Upcharge for mixed surface grades, refer to the electronic design and specification for pricing.

NOTES:

- Non-powered panels ship without receptacle ports in the base raceway cover.
- Some building codes may restrict the use of panel heights greater than 69"(1753mm). Consult your local code authority to assure that the furniture layout is compliant.
- For International Power, specify non-powered panels and use Power Logic components. See Specification Guide for more information on Power Logic.
- For Chicago power, specify non-powered panels without a base raceway cover. Separately specify Chicago power retrofit kit.



OBSOLETE / April 2024

Laminate Monolithic Panel — No Power

UniGroup Too

Laminate	Actual Height	Width	Number ①	Laminate A		Laminate B	
				Trim A	Trim B	Trim A	Trim B
32"(813mm)	24"(610mm)	E2DN-230-		\$1765.07	\$1797.93	\$1835.37	\$1868.23
	30"(762mm)	E2DN-3030-		1855.25	1889.19	1936.35	1970.29
	36"(914mm)	E2DN-330-		1945.43	1980.45	2037.33	2072.35
	42"(1067mm)	E2DN-4230-		2035.61	2071.71	2138.31	2174.41
	48"(1219mm)	E2DN-430-		2125.79	2162.97	2239.29	2276.47
	60"(1524mm)	E2DN-530-		2306.15	2345.49	2441.25	2480.59
40"(1016mm)	24"(610mm)	E2DN-238-		\$1872.91	\$1906.89	\$1954.73	\$1988.71
	30"(762mm)	E2DN-3038-		1985.17	2020.23	2080.67	2115.73
	36"(914mm)	E2DN-338-		2097.43	2133.57	2206.61	2242.75
	42"(1067mm)	E2DN-4238-		2209.69	2245.83	2325.55	2369.77
	48"(1219mm)	E2DN-438-		2321.95	2358.09	2458.49	2496.79
	60"(1524mm)	E2DN-538-		2546.47	2582.61	2710.37	2750.83
48"(1219mm)	24"(610mm)	E2DN-246-		\$1980.75	\$2014.73	\$2074.09	\$2109.19
	30"(762mm)	E2DN-3046-		2115.01	2151.15	2224.99	2261.17
	36"(914mm)	E2DN-346-		2249.43	2286.69	2375.89	2413.15
	42"(1067mm)	E2DN-4246-		2383.77	2422.11	2526.79	2565.13
	48"(1219mm)	E2DN-446-		2518.11	2557.53	2677.69	2717.11
	60"(1524mm)	E2DN-546-		2752.45	2828.37	2979.49	3021.07
56"(1422mm)	24"(610mm)	E2DN-254-		\$2088.59	\$2124.81	\$2193.45	\$2229.67
	30"(762mm)	E2DN-3054-		2245.01	2282.31	2369.31	2406.61
	36"(914mm)	E2DN-354-		2401.43	2439.81	2545.17	2583.55
	42"(1067mm)	E2DN-4254-		2557.85	2597.31	2721.03	2760.49
	48"(1219mm)	E2DN-454-		2714.27	2754.81	2896.89	2937.43
	60"(1524mm)	E2DN-554-		3027.11	3069.81	3248.61	3291.31
64"(1626mm)	24"(610mm)	E2DN-262-		\$2196.43	\$2233.77	\$2312.81	\$2350.15
	30"(762mm)	E2DN-3062-		2374.93	2413.35	2513.63	2552.05
	36"(914mm)	E2DN-362-		2553.43	2592.93	2714.45	2753.95
	42"(1067mm)	E2DN-4262-		2731.93	2772.51	2915.27	2955.85
	48"(1219mm)	E2DN-462-		2910.43	2952.09	3116.09	3157.75
	60"(1524mm)	E2DN-562-		3267.43	3311.25	3517.73	3561.55
72"(1829mm)	24"(610mm)	E2DN-270-		\$2304.27	\$2342.73	\$2432.17	\$2470.63
	30"(762mm)	E2DN-3070-		2504.85	2544.39	2657.95	2697.49
	36"(914mm)	E2DN-370-		2705.43	2746.05	2883.73	2924.35
	42"(1067mm)	E2DN-4270-		2906.01	2947.71	3109.51	3151.21
	48"(1219mm)	E2DN-470-		3106.59	3149.37	3335.29	3378.07
	60"(1524mm)	E2DN-570-		3507.75	3552.69	3786.85	3831.79
80"(2032mm)	24"(610mm)	E2DN-278-		\$2412.11	\$2451.69	\$2551.53	\$2591.11
	30"(762mm)	E2DN-3078-		2634.77	2675.43	2802.27	2842.93
	36"(914mm)	E2DN-378-		2857.43	2899.17	3053.01	3094.75
	42"(1067mm)	E2DN-4278-		3080.09	3122.91	3303.75	3346.57
	48"(1219mm)	E2DN-478-		3302.75	3346.65	3554.49	3598.39
	60"(1524mm)	E2DN-578-		3748.07	3794.13	4055.97	4102.03

OBSOLETE! April 2024

Laminate Monolithic Panel — Powered

UniGroup Too

Laminate

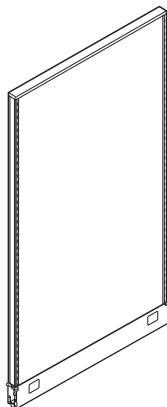

E2DP-B (3-circuit)
E2DP-2 (4-circuit, 2+2)
E2DP-4 (4-circuit, 3+1)



Features

- Includes powered panel assembly, square top cap with aligner, with or without one-piece base raceway cover, 1.6 hinge kits, side trim rails, leveling glides and carpet gripper; power distribution assembly/flex connector(s). .6 top cap end plugs and base raceway end caps are shipped with each panel. Order additional as necessary.
- Panel surfaces may have the same laminate surface color on both sides or a different laminate surface color on each side.
- Panel thickness is 2”(51mm).
- Base raceway is 4”(102mm) high.
- Powered raceway with or without raceway cover requires modified catalog number and list price.
- Powered panels are available for countries that utilize 120 volt 60 hertz electrical systems and U.S. configured plugs and outlets.
- Shipped with unassembled top cap, base raceway cover and side trim rails.

Specification Tips

- Both sides in the same color laminate or different color laminate on each side.
- Panels will accept add-on panels up to a combined height of 80”(2032mm). For aesthetic consistency, specify UniGroup Too add-on panels.
- Flex connectors provided for powered monolithic panels accommodate straight in-line, inside 90°, and inside 120° conditions (if applicable).
- Receptacles for powered panels must be specified separately.
- Raceway cover must be separately specified for option -BE, BYE, 2E, 2YE, 4E or 4YE (no raceway cover).
- If 90° top cap for four-way and 120° top cap for three-way are not specified, additional top cap end plugs will need to be ordered.
- Additional top cap end plugs and base raceway end caps will need to be specified if finishes are not ordered.

To Order, Specify:

1) Product number, including:

1 3-Circuit

- B** With Raceway Cover
- BE** Without Raceway Cover, deduct **\$138.36** list
- BY** NYC with Raceway Cover
- BYE** NYC without Raceway Cover, deduct **\$138.36** list

4-Circuit, 2+2

- 2** With Raceway Cover, add **\$46.18** list
- 2E** Without Raceway Cover, deduct **\$92.18** list
- 2Y** NYC with Raceway Cover, add **\$46.18** list
- 2YE** NYC without Raceway Cover, deduct **\$92.18** list

4-Circuit, 3+1

- 4** With Raceway Cover, add **\$46.18** list
- 4E** Without Raceway Cover, deduct **\$92.18** list
- 4Y** NYC with Raceway Cover, add **\$46.18** list
- 4YE** NYC without Raceway Cover, deduct **\$92.18** list

- Laminate surface color for panel side one.
- Laminate surface color for panel side two.
- Trim color raceway cover, glide housings and end caps.
- Trim color for top cap and side trim rails.

Note: Upcharge for mixed surface grades, refer to the electronic design and specification tools for pricing.

NOTES:

- Powered panels with raceway covers ship with receptacle ports in the base raceway cover. Receptacle ports on the raceway cover measure 2.35”(60mm) top-to-bottom and 2.88”(73mm) side-to-side.
- Powered panels with Power Distribution Assembly (PDA) but without raceway covers require separately specified base raceway covers for power and communication port locations other than the standard powered base raceway cover.
- New York City (NYC) electrical applications require metal installation of PDA.
- New York Port Authority (NYPA) electrical applications require metal raceway covers. To order, specify NYC powered panels without raceway cover and separately specify metal covers through Haworth e-Parts.
- Some building codes may restrict the use of panel heights greater than 69”(1753mm). Consult your local code authority to assure that the furniture layout is compliant.
- For International Power, specify non-powered panels and use Power Logic components. See Specification Guide for more information on Power Logic.
- For Chicago power, specify non-powered panels without a base raceway cover and separately specify Chicago power retrofit kit.

Laminate Monolithic Panel — Powered

UniGroup Too

Laminate	Actual Height	Width	Number ①	Laminate A		Laminate B	
				Trim A	Trim B	Trim A	Trim B
32"(813mm)	24"(610mm)	E2DP-230-		\$2216.11	\$2387.33	\$2286.41	\$2457.63
	30"(762mm)	E2DP-3030-		2306.29	2478.59	2387.39	2559.69
	36"(914mm)	E2DP-330-		2396.47	2569.85	2488.37	2661.75
	42"(1067mm)	E2DP-4230-		2486.65	2661.11	2589.35	2763.81
	48"(1219mm)	E2DP-430-		2576.83	2752.37	2690.33	2865.87
	60"(1524mm)	E2DP-530-		2757.19	2934.89	2892.29	3069.99
40"(1016mm)	24"(610mm)	E2DP-238-		\$2323.95	\$2496.29	\$2405.77	\$2578.11
	30"(762mm)	E2DP-3038-		2436.21	2609.63	2531.71	2705.13
	36"(914mm)	E2DP-338-		2548.47	2722.97	2657.65	2832.15
	42"(1067mm)	E2DP-4238-		2660.73	2836.31	2783.59	2959.17
	48"(1219mm)	E2DP-438-		2772.99	2949.65	2909.53	3086.19
	60"(1524mm)	E2DP-538-		2997.51	3162.99	3161.41	3340.23
48"(1219mm)	24"(610mm)	E2DP-246-		\$2431.79	\$2604.13	\$2525.13	\$2698.59
	30"(762mm)	E2DP-3046-		2566.11	2777.47	2676.03	2850.57
	36"(914mm)	E2DP-346-		2700.47	2890.81	2826.93	3002.55
	42"(1067mm)	E2DP-4246-		2834.81	3011.51	2977.83	3154.53
	48"(1219mm)	E2DP-446-		2969.15	3146.93	3128.73	3306.51
	60"(1524mm)	E2DP-546-		3203.49	3417.77	3430.53	3610.47
56"(1422mm)	24"(610mm)	E2DP-254-		\$2535.63	\$2714.21	\$2644.49	\$2819.07
	30"(762mm)	E2DP-3054-		2669.97	2871.71	2820.35	2996.01
	36"(914mm)	E2DP-354-		2852.47	3029.21	2996.21	3172.95
	42"(1067mm)	E2DP-4254-		3008.89	3186.71	3172.07	3349.89
	48"(1219mm)	E2DP-454-		3165.31	3344.21	3347.93	3526.83
	60"(1524mm)	E2DP-554-		3478.15	3659.21	3699.65	3880.71
64"(1626mm)	24"(610mm)	E2DP-262-		\$2647.47	\$2823.17	\$2763.85	\$2939.55
	30"(762mm)	E2DP-3062-		2825.97	3002.75	2964.67	3141.45
	36"(914mm)	E2DP-362-		3004.47	3182.33	3165.49	3343.35
	42"(1067mm)	E2DP-4262-		3182.97	3361.91	3366.31	3545.25
	48"(1219mm)	E2DP-462-		3361.47	3541.49	3567.13	3747.15
	60"(1524mm)	E2DP-562-		3718.47	3900.65	3968.77	4150.95
72"(1829mm)	24"(610mm)	E2DP-270-		\$2755.31	\$2932.13	\$2883.21	\$3060.03
	30"(762mm)	E2DP-3070-		2955.89	3133.79	3108.99	3286.89
	36"(914mm)	E2DP-370-		3156.47	3335.45	3334.77	3513.75
	42"(1067mm)	E2DP-4270-		3357.05	3537.11	3560.55	3740.61
	48"(1219mm)	E2DP-470-		3557.63	3738.77	3786.33	3967.47
	60"(1524mm)	E2DP-570-		3958.79	4142.09	4237.89	4421.19
80"(2032mm)	24"(610mm)	E2DP-278-		\$2863.15	\$3041.09	\$3002.57	\$3180.51
	30"(762mm)	E2DP-3078-		3085.81	3264.83	3253.31	3432.33
	36"(914mm)	E2DP-378-		3308.47	3488.57	3504.05	3684.15
	42"(1067mm)	E2DP-4278-		3531.13	3712.31	3754.79	3935.97
	48"(1219mm)	E2DP-478-		3753.79	3936.05	4005.53	4187.79
	60"(1524mm)	E2DP-578-		4199.11	4383.53	4507.01	4691.43

OBSOLETE! April 2024

This page intentionally blank

Fabric Monolithic Panel — No Power

UniGroup Too

Fabric

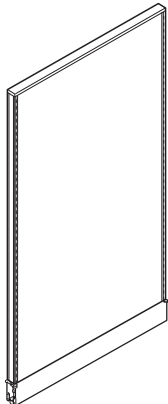

E2FN-B (Non-Powered)

NOTE:

This panel has fabric/colorway restrictions, see systems fabrics/ color legend.

Features

- Includes non-powered panel assembly, square top cap with aligner, with or without one-piece base raceway cover, 1.6 hinge kits, side trim rails, leveling glides and carpet gripper. .6 top cap end plugs and base raceway end caps are shipped with each panel. Order additional as necessary.
- High acoustical panel surfaces over 0.5”(13mm) thick fiber board.
- Panel surfaces may have the same fabric on both sides or a different fabric on each side.
- Panel thickness is 2”(51mm).
- Base raceway is 4”(102mm) high.
- Shipped with unassembled top cap, base raceway cover and side trim rails.

Specification Tips

- Panels will accept add-on panels up to a combined height of 80”(2032mm). For aesthetic consistency, specify UniGroup Too add-on panels.
- Raceway cover must be separately specified for option -BE (no raceway cover).
- If 90° top cap for four-way and 120° top cap for three-way are not specified, additional top cap end plugs will need to be ordered.
- Additional top cap end plugs and base raceway end caps will need to be specified if finish posts are not ordered.

To Order, Specify:

- 1) Product number, including:

① Options:

B With Raceway Cover

BE Without Raceway Cover, deduct **\$122.58** list

- 2) Fabric/colorway for panel side one.
- 3) Fabric/colorway for panel side two.
- 4) Trim color raceway cover, glide housings and end caps.
- 5) Trim color for top cap and side trim rails.

Note: Upcharge for mixed surface grades, refer to the electronic design and specification tools for pricing.

NOTES:

- Non-powered panels ship without receptacle ports in the base raceway cover.
- Some building codes may restrict the use of panel heights greater than 69”(1753mm). Consult your local code authority to assure that the furniture layout is compliant.
- For International Power, specify non-powered panels and use Power Logic components. See Specification Guide for more information on Power Logic.
- For Chicago power, specify non-powered panels without a base raceway cover and separately specify Chicago power retrofit kit.

Fabric Monolithic Panel — No Power

UniGroup Too

Fabric	Actual Height	Width	Number ①	Trim A					G
				Fabric Grade A	B	C	E	F	
32"(813mm)	24"(610mm)	E2FN-230-	■ ■	\$1083.45	\$1199.61	\$1327.45	\$1606.31	\$1792.19	\$1908.29
	30"(762mm)	E2FN-3030-	■ ■	1145.91	1265.67	1400.71	1701.17	1901.45	2021.15
	36"(914mm)	E2FN-330-	■ ■	1206.03	1329.39	1471.63	1793.69	2008.37	2131.67
	42"(1067mm)	E2FN-4230-	■ ■	1266.15	1393.11	1542.55	1886.21	2115.29	2242.19
	48"(1219mm)	E2FN-430-	■ ■	1326.27	1456.83	1613.47	1978.73	2222.21	2352.71
	60"(1524mm)	E2FN-530-	■ ■	1448.85	1586.61	1757.65	2166.11	2438.39	2576.09
40"(1016mm)	24"(610mm)	E2FN-238-	■ ■	\$1161.41	\$1281.41	\$1416.93	\$1718.83	\$1920.07	\$2040.01
	30"(762mm)	E2FN-3038-	■ ■	1234.97	1359.53	1504.17	1833.43	2052.91	2177.41
	36"(914mm)	E2FN-338-	■ ■	1310.87	1439.99	1593.75	1950.37	2188.09	2317.15
	42"(1067mm)	E2FN-4238-	■ ■	1386.77	1520.45	1683.33	2067.31	2323.27	2456.89
	48"(1219mm)	E2FN-438-	■ ■	1460.33	1598.57	1770.57	2181.91	2456.11	2594.29
	60"(1524mm)	E2FN-538-	■ ■	1609.79	1757.15	1947.39	2413.45	2724.13	2871.43
48"(1219mm)	24"(610mm)	E2FN-246-	■ ■	\$1237.03	\$1360.87	\$1504.07	\$1829.01	\$2045.61	\$2169.39
	30"(762mm)	E2FN-3046-	■ ■	1326.37	1455.73	1609.97	1968.03	2206.71	2336.01
	36"(914mm)	E2FN-346-	■ ■	1415.71	1550.59	1715.87	2107.05	2367.81	2502.63
	42"(1067mm)	E2FN-4246-	■ ■	1505.05	1645.45	1821.77	2246.07	2528.91	2669.25
	48"(1219mm)	E2FN-446-	■ ■	1594.39	1740.31	1927.67	2385.09	2690.01	2835.87
	60"(1524mm)	E2FN-546-	■ ■	1773.07	1930.03	2139.47	2663.13	3012.21	3169.11
56"(1422mm)	24"(610mm)	E2FN-254-	■ ■	\$1312.65	\$1440.33	\$1591.21	\$1939.19	\$2171.15	\$2298.77
	30"(762mm)	E2FN-3054-	■ ■	1417.77	1551.93	1715.77	2102.63	2360.51	2494.61
	36"(914mm)	E2FN-354-	■ ■	1520.55	1661.19	1837.99	2263.73	2547.53	2688.11
	42"(1067mm)	E2FN-4254-	■ ■	1623.33	1770.45	1960.21	2424.83	2734.55	2881.61
	48"(1219mm)	E2FN-454-	■ ■	1726.11	1879.71	2082.43	2585.93	2921.57	3075.11
	60"(1524mm)	E2FN-554-	■ ■	1934.01	2100.57	2329.21	2910.47	3297.95	3464.45
64"(1626mm)	24"(610mm)	E2FN-262-	■ ■	\$1390.61	\$1522.13	\$1680.69	\$2051.71	\$2299.03	\$2430.49
	30"(762mm)	E2FN-3062-	■ ■	1506.83	1645.79	1819.23	2234.89	2511.97	2650.87
	36"(914mm)	E2FN-362-	■ ■	1625.39	1771.79	1960.11	2420.41	2727.25	2873.59
	42"(1067mm)	E2FN-4262-	■ ■	1743.95	1897.79	2100.99	2605.93	2942.53	3096.31
	48"(1219mm)	E2FN-462-	■ ■	1860.17	2021.45	2239.53	2789.11	3155.47	3316.69
	60"(1524mm)	E2FN-562-	■ ■	2094.95	2271.11	2518.95	3157.81	3583.69	3759.79
72"(1829mm)	24"(610mm)	E2FN-270-	■ ■	\$1466.23	\$1601.59	\$1767.83	\$2161.89	\$2424.57	\$2559.87
	30"(762mm)	E2FN-3070-	■ ■	1598.23	1741.99	1925.03	2369.49	2665.77	2809.47
	36"(914mm)	E2FN-370-	■ ■	1730.23	1882.39	2082.23	2577.09	2906.97	3059.07
	42"(1067mm)	E2FN-4270-	■ ■	1862.23	2022.79	2239.43	2784.69	3148.17	3308.67
	48"(1219mm)	E2FN-470-	■ ■	1994.23	2163.19	2396.63	2992.29	3389.37	3558.27
	60"(1524mm)	E2FN-570-	■ ■	2258.23	2443.99	2711.03	3407.49	3871.77	4057.47
80"(2032mm)	24"(610mm)	E2FN-278-	■ ■	\$1541.85	\$1681.05	\$1854.97	\$2272.07	\$2550.11	\$2689.25
	30"(762mm)	E2FN-3078-	■ ■	1689.63	1838.19	2030.83	2504.09	2819.57	2968.07
	36"(914mm)	E2FN-378-	■ ■	1835.07	1992.99	2204.35	2733.77	3086.69	3244.55
	42"(1067mm)	E2FN-4278-	■ ■	1980.51	2147.79	2377.87	2963.45	3353.81	3521.03
	48"(1219mm)	E2FN-478-	■ ■	2125.95	2302.59	2551.39	3193.13	3620.93	3797.51
	60"(1524mm)	E2FN-578-	■ ■	2419.17	2614.53	2900.77	3654.83	4157.51	4352.81

Fabric Monolithic Panel — No Power

UniGroup Too

Fabric	Actual Height	Width	Number ①	Trim B Fabric Grade					
				A	B	C	E	F	G
32"(813mm)	24"(610mm)	E2FN-230-	■ ■	\$1116.31	\$1232.47	\$1360.31	\$1639.17	\$1825.05	\$1941.15
	30"(762mm)	E2FN-3030-	■ ■	1179.85	1299.61	1434.65	1735.11	1935.39	2055.09
	36"(914mm)	E2FN-330-	■ ■	1241.05	1364.41	1506.65	1828.71	2043.39	2166.69
	42"(1067mm)	E2FN-4230-	■ ■	1302.25	1429.21	1578.65	1922.31	2151.39	2278.29
	48"(1219mm)	E2FN-430-	■ ■	1363.45	1494.01	1650.65	2015.91	2259.39	2389.89
	60"(1524mm)	E2FN-530-	■ ■	1488.19	1625.95	1796.99	2205.45	2477.73	2615.43
40"(1016mm)	24"(610mm)	E2FN-238-	■ ■	\$1195.39	\$1315.39	\$1450.91	\$1752.81	\$1954.05	\$2073.99
	30"(762mm)	E2FN-3038-	■ ■	1270.03	1394.59	1539.23	1868.49	2087.97	2212.47
	36"(914mm)	E2FN-338-	■ ■	1347.01	1476.13	1629.89	1986.51	2224.23	2353.29
	42"(1067mm)	E2FN-4238-	■ ■	1423.99	1557.67	1720.55	2104.53	2360.49	2494.11
	48"(1219mm)	E2FN-438-	■ ■	1498.63	1636.87	1808.87	2220.21	2494.41	2632.59
	60"(1524mm)	E2FN-538-	■ ■	1650.25	1797.61	1987.85	2453.91	2764.59	2911.89
48"(1219mm)	24"(610mm)	E2FN-246-	■ ■	\$1272.13	\$1395.97	\$1539.17	\$1864.11	\$2080.71	\$2204.49
	30"(762mm)	E2FN-3046-	■ ■	1362.55	1491.91	1646.15	2004.21	2242.89	2372.19
	36"(914mm)	E2FN-346-	■ ■	1452.97	1587.85	1753.13	2144.31	2405.07	2539.89
	42"(1067mm)	E2FN-4246-	■ ■	1543.39	1683.79	1860.11	2284.41	2567.25	2707.59
	48"(1219mm)	E2FN-446-	■ ■	1633.81	1779.73	1967.09	2424.51	2729.43	2875.29
	60"(1524mm)	E2FN-546-	■ ■	1814.65	1971.61	2181.05	2704.71	3053.79	3210.69
56"(1422mm)	24"(610mm)	E2FN-254-	■ ■	\$1348.87	\$1476.55	\$1627.43	\$1975.41	\$2207.37	\$2334.99
	30"(762mm)	E2FN-3054-	■ ■	1455.07	1589.23	1753.07	2139.93	2397.81	2531.91
	36"(914mm)	E2FN-354-	■ ■	1558.93	1699.57	1876.37	2302.11	2585.91	2726.49
	42"(1067mm)	E2FN-4254-	■ ■	1662.79	1809.91	1999.67	2464.29	2774.01	2921.07
	48"(1219mm)	E2FN-454-	■ ■	1766.65	1920.25	2122.97	2626.47	2962.11	3115.65
	60"(1524mm)	E2FN-554-	■ ■	1976.71	2143.27	2371.91	2953.17	3340.65	3507.15
64"(1626mm)	24"(610mm)	E2FN-262-	■ ■	\$1427.95	\$1559.47	\$1718.03	\$2089.05	\$2336.37	\$2467.83
	30"(762mm)	E2FN-3062-	■ ■	1545.25	1684.21	1857.65	2273.31	2550.39	2689.29
	36"(914mm)	E2FN-362-	■ ■	1664.89	1811.29	1999.61	2459.91	2766.75	2913.09
	42"(1067mm)	E2FN-4262-	■ ■	1784.53	1938.37	2141.57	2646.51	2983.11	3136.89
	48"(1219mm)	E2FN-462-	■ ■	1901.83	2063.11	2281.19	2830.77	3197.13	3358.35
	60"(1524mm)	E2FN-562-	■ ■	2138.77	2314.93	2562.77	3201.63	3627.51	3803.61
72"(1829mm)	24"(610mm)	E2FN-270-	■ ■	\$1504.69	\$1640.05	\$1806.29	\$2200.35	\$2463.03	\$2598.33
	30"(762mm)	E2FN-3070-	■ ■	1637.77	1781.53	1964.57	2409.03	2705.31	2849.01
	36"(914mm)	E2FN-370-	■ ■	1770.85	1923.01	2122.85	2617.71	2947.59	3099.69
	42"(1067mm)	E2FN-4270-	■ ■	1903.93	2064.49	2281.13	2826.39	3189.87	3350.37
	48"(1219mm)	E2FN-470-	■ ■	2037.01	2205.97	2439.41	3035.07	3432.15	3601.05
	60"(1524mm)	E2FN-570-	■ ■	2303.17	2488.93	2755.97	3452.43	3916.71	4102.41
80"(2032mm)	24"(610mm)	E2FN-278-	■ ■	\$1581.43	\$1720.63	\$1894.55	\$2311.65	\$2589.69	\$2728.83
	30"(762mm)	E2FN-3078-	■ ■	1730.29	1878.85	2071.49	2544.75	2860.23	3008.73
	36"(914mm)	E2FN-378-	■ ■	1876.81	2034.73	2246.09	2775.51	3128.43	3286.29
	42"(1067mm)	E2FN-4278-	■ ■	2023.33	2190.61	2420.69	3006.27	3396.63	3563.85
	48"(1219mm)	E2FN-478-	■ ■	2169.85	2346.49	2595.29	3237.03	3664.83	3841.41
	60"(1524mm)	E2FN-578-	■ ■	2465.23	2660.59	2946.83	3700.89	4203.57	4398.87

This page intentionally blank

Fabric Monolithic Panel — Powered

UniGroup Too

Fabric

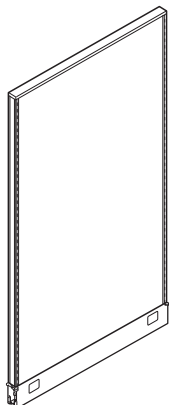

E2FP-B (3-circuit)
E2FP-2 (4-circuit, 2+2)
E2FP-4 (4-circuit, 3+1)



NOTE:

This panel has fabric/colorway restrictions, see systems fabrics/ color legend.

Features

- Includes powered panel assembly, square top cap with aligner, with or without one-piece base raceway cover, 1.6 hinge kits, side trim rails, leveling glides and carpet gripper; power distribution assembly/flex connector(s). .6 top cap end plugs and base raceway end caps are shipped with each panel. Order additional as necessary.
- High acoustical panel surfaces over 0.5"(13mm) thick fiber board.
- Panel surfaces may have the same fabric on both sides or a different fabric on each side.
- Panel thickness is 2"(51mm).
- Base raceway is 4"(102mm) high.
- Powered raceway with or without raceway cover requires modified catalog number and list price.
- Powered panels are available for countries that utilize 120 volt 60 hertz electrical systems and U.S. configured plugs and outlets.
- Shipped with unassembled top cap, base raceway cover and side trim rails.

Specification Tips

- Panels will accept add-on panels up to a combined height of 80"(2032mm). For aesthetic consistency, specify UniGroup Too add-on panels.
- Flex connectors provided for powered monolithic panels accommodate straight in-line, inside 90°, and inside 120° conditions (if applicable).
- Receptacles for powered panels must be specified separately.
- Raceway cover must be separately specified for option -BE, BYE, 2E, 2YE, 4E or 4YE (no raceway cover).
- If 90° top cap for four-way and 120° top cap for three-way are not specified, additional top cap end plugs will need to be ordered.
- Additional top cap end plugs and base raceway end caps will need to be specified if finish posts are not ordered.

To Order, Specify:

- Product number, including:

1 3-Circuit

- B** With Raceway Cover
- BE** Without Raceway Cover, deduct **\$138.36** list
- BY** NYC with Raceway Cover
- BYE** NYC without Raceway Cover, deduct **\$138.36** list

4-Circuit, 2+2

- 2** With Raceway Cover, add **\$46.18** list
- 2E** Without Raceway Cover, deduct **\$92.18** list
- 2Y** NYC with Raceway Cover, add **\$46.18** list
- 2YE** NYC without Raceway Cover, deduct **\$92.18** list

4-Circuit, 3+1

- 4** With Raceway Cover, add **\$46.18** list
- 4E** Without Raceway Cover, deduct **\$92.18** list
- 4Y** NYC with Raceway Cover, add **\$46.18** list
- 4YE** NYC without Raceway Cover, deduct **\$92.18** list

- Fabric/colorway for panel side one.
- Fabric side two.
- Trim color raceway cover, glide housings and end caps.
- Trim color for top cap and side trim rails.

Note: Upcharge for mixed surface grades, refer to the electronic design and specification tools for pricing.

NOTES:

- Powered panels with raceway covers ship with receptacle ports in the base raceway cover. Receptacle ports on the raceway cover measure 2.35"(60mm) top-to-bottom and 2.88"(73mm) side-to-side.
- Powered panels with Power Distribution Assemblies (PDA) but without raceway covers require separately specified base raceway covers for power and communication port locations other than the standard powered base raceway cover.
- New York City (NYC) electrical applications require field installation of PDA.
- New York Port Authority (NYPA) electrical applications require metal raceway covers. To order, specify NYC powered panels without raceway cover and separately specify metal covers through Haworth e-Parts.
- Some building codes may restrict the use of panel heights greater than 69"(1753mm). Consult your local code authority to assure that the furniture layout is compliant.
- For International Power, specify non-powered panels and use Power Logic components. See Specification Guide for more information on Power Logic.
- For Chicago power, specify non-powered panels without a base raceway cover and separately specify Chicago power retrofit kit.

Fabric Monolithic Panel — Powered

UniGroup Too

Fabric	Actual Height	Width	Number ①	Trim A Fabric Grade					
				A	B	C	E	F	G
32"(813mm)	24"(610mm)	E2FP-230-		\$1534.49	\$1650.65	\$1778.49	\$2057.35	\$2243.23	\$2359.33
	30"(762mm)	E2FP-3030-		1596.95	1716.71	1851.75	2152.21	2352.49	2472.19
	36"(914mm)	E2FP-330-		1657.07	1780.43	1922.67	2244.73	2459.41	2582.71
	42"(1067mm)	E2FP-4230-		1717.19	1844.15	1993.59	2337.25	2566.33	2693.23
	48"(1219mm)	E2FP-430-		1777.31	1907.87	2064.51	2429.77	2673.25	2803.75
	60"(1524mm)	E2FP-530-		1899.89	2037.65	2208.69	2617.15	2889.43	3027.13
40"(1016mm)	24"(610mm)	E2FP-238-		\$1612.45	\$1732.45	\$1867.97	\$2169.87	\$2371.11	\$2491.05
	30"(762mm)	E2FP-3038-		1686.01	1810.57	1955.21	2284.47	2503.95	2628.45
	36"(914mm)	E2FP-338-		1761.91	1891.03	2044.79	2401.41	2639.13	2768.19
	42"(1067mm)	E2FP-4238-		1837.81	1971.49	2134.37	2518.35	2774.31	2907.93
	48"(1219mm)	E2FP-438-		1911.37	2049.61	2221.61	2632.95	2907.15	3045.33
	60"(1524mm)	E2FP-538-		2060.83	2208.19	2398.43	2864.49	3175.17	3322.47
48"(1219mm)	24"(610mm)	E2FP-246-		\$1688.07	\$1811.91	\$1955.11	\$2280.05	\$2496.65	\$2620.43
	30"(762mm)	E2FP-3046-		1777.41	1906.77	2061.01	2419.07	2657.75	2787.05
	36"(914mm)	E2FP-346-		1866.75	2001.63	2166.91	2558.09	2818.85	2953.67
	42"(1067mm)	E2FP-4246-		1956.09	2096.49	2272.81	2697.11	2979.95	3120.29
	48"(1219mm)	E2FP-446-		2045.43	2191.35	2378.71	2836.13	3141.05	3286.91
	60"(1524mm)	E2FP-546-		2224.11	2381.07	2590.51	3114.17	3463.25	3620.15
56"(1422mm)	24"(610mm)	E2FP-254-		\$1763.69	\$1891.37	\$2042.25	\$2390.23	\$2622.19	\$2749.81
	30"(762mm)	E2FP-3054-		1868.81	2002.97	2166.81	2553.67	2811.55	2945.65
	36"(914mm)	E2FP-354-		1971.59	2112.23	2289.03	2714.77	2998.57	3139.15
	42"(1067mm)	E2FP-4254-		2074.37	2221.49	2411.25	2875.87	3185.59	3332.65
	48"(1219mm)	E2FP-454-		2177.15	2330.75	2533.47	3036.97	3372.61	3526.15
	60"(1524mm)	E2FP-554-		2385.05	2551.61	2780.25	3361.51	3748.99	3915.49
64"(1626mm)	24"(610mm)	E2FP-262-		\$1841.65	\$1973.17	\$2131.73	\$2502.75	\$2750.07	\$2881.53
	30"(762mm)	E2FP-3062-		1957.87	2096.83	2270.27	2685.93	2963.01	3101.91
	36"(914mm)	E2FP-362-		2076.43	2222.83	2411.15	2871.45	3178.29	3324.63
	42"(1067mm)	E2FP-4262-		2194.99	2348.83	2552.03	3056.97	3393.57	3547.35
	48"(1219mm)	E2FP-462-		2311.21	2472.49	2690.57	3240.15	3606.51	3767.73
	60"(1524mm)	E2FP-562-		2545.99	2722.15	2969.99	3608.85	4034.73	4210.83
72"(1829mm)	24"(610mm)	E2FP-270-		\$1917.27	\$2052.63	\$2218.87	\$2612.93	\$2875.61	\$3010.91
	30"(762mm)	E2FP-3070-		2049.27	2193.03	2376.07	2820.53	3116.81	3260.51
	36"(914mm)	E2FP-370-		2181.27	2333.43	2533.27	3028.13	3358.01	3510.11
	42"(1067mm)	E2FP-4270-		2313.27	2473.83	2690.47	3235.73	3599.21	3759.71
	48"(1219mm)	E2FP-470-		2445.27	2614.23	2847.67	3443.33	3840.41	4009.31
	60"(1524mm)	E2FP-570-		2709.27	2895.03	3162.07	3858.53	4322.81	4508.51
80"(2032mm)	24"(610mm)	E2FP-278-		\$1992.89	\$2132.09	\$2306.01	\$2723.11	\$3001.15	\$3140.29
	30"(762mm)	E2FP-3078-		2140.67	2289.23	2481.87	2955.13	3270.61	3419.11
	36"(914mm)	E2FP-378-		2286.11	2444.03	2655.39	3184.81	3537.73	3695.59
	42"(1067mm)	E2FP-4278-		2431.55	2598.83	2828.91	3414.49	3804.85	3972.07
	48"(1219mm)	E2FP-478-		2576.99	2753.63	3002.43	3644.17	4071.97	4248.55
	60"(1524mm)	E2FP-578-		2870.21	3065.57	3351.81	4105.87	4608.55	4803.85

Fabric Monolithic Panel — Powered

UniGroup Too

Fabric	Actual Height	Width	Number ①	Trim B Fabric Grade					
				A	B	C	E	F	G
32"(813mm)	24"(610mm)	E2FP-230-	■ ■	\$1705.71	\$1821.87	\$1949.71	\$2228.57	\$2414.45	\$2530.55
	30"(762mm)	E2FP-3030-	■ ■	1769.25	1889.01	2024.05	2324.51	2524.79	2644.49
	36"(914mm)	E2FP-330-	■ ■	1830.45	1953.81	2096.05	2418.11	2632.79	2756.09
	42"(1067mm)	E2FP-4230-	■ ■	1891.65	2018.61	2168.05	2511.71	2740.79	2867.69
	48"(1219mm)	E2FP-430-	■ ■	1952.85	2083.41	2240.05	2605.31	2848.79	2979.29
	60"(1524mm)	E2FP-530-	■ ■	2077.59	2215.35	2386.39	2794.85	3067.13	3204.83
40"(1016mm)	24"(610mm)	E2FP-238-	■ ■	\$1784.79	\$1904.79	\$2040.31	\$2342.21	\$2543.45	\$2663.39
	30"(762mm)	E2FP-3038-	■ ■	1859.43	1983.99	2128.63	2457.89	2677.37	2801.87
	36"(914mm)	E2FP-338-	■ ■	1936.41	2065.53	2219.29	2575.91	2813.63	2942.69
	42"(1067mm)	E2FP-4238-	■ ■	2013.39	2147.07	2309.95	2693.93	2949.89	3083.51
	48"(1219mm)	E2FP-438-	■ ■	2088.03	2226.27	2398.27	2809.61	3083.81	3221.99
	60"(1524mm)	E2FP-538-	■ ■	2239.65	2387.01	2577.25	3043.31	3353.99	3501.29
48"(1219mm)	24"(610mm)	E2FP-246-	■ ■	\$1861.53	\$1985.37	\$2128.57	\$2453.51	\$2670.11	\$2793.89
	30"(762mm)	E2FP-3046-	■ ■	1951.95	2081.31	2235.55	2593.61	2832.29	2961.59
	36"(914mm)	E2FP-346-	■ ■	2042.37	2177.25	2342.53	2733.71	2994.47	3129.29
	42"(1067mm)	E2FP-4246-	■ ■	2132.79	2273.19	2449.51	2873.81	3156.65	3296.99
	48"(1219mm)	E2FP-446-	■ ■	2223.21	2369.13	2556.49	3013.91	3318.83	3464.69
	60"(1524mm)	E2FP-546-	■ ■	2404.05	2561.01	2770.45	3294.11	3643.19	3800.09
56"(1422mm)	24"(610mm)	E2FP-254-	■ ■	\$1938.27	\$2065.95	\$2216.83	\$2564.81	\$2796.77	\$2924.39
	30"(762mm)	E2FP-3054-	■ ■	2044.47	2178.63	2342.47	2729.33	2987.21	3121.31
	36"(914mm)	E2FP-354-	■ ■	2148.33	2288.97	2465.77	2891.51	3175.31	3315.89
	42"(1067mm)	E2FP-4254-	■ ■	2252.19	2399.31	2589.07	3053.69	3363.41	3510.47
	48"(1219mm)	E2FP-454-	■ ■	2356.05	2509.65	2712.37	3215.87	3551.51	3705.05
	60"(1524mm)	E2FP-554-	■ ■	2566.11	2732.67	2961.31	3542.57	3930.05	4096.55
64"(1626mm)	24"(610mm)	E2FP-262-	■ ■	\$2017.35	\$2148.87	\$2307.43	\$2678.45	\$2925.77	\$3057.23
	30"(762mm)	E2FP-3062-	■ ■	2134.65	2273.61	2447.05	2862.71	3139.79	3278.69
	36"(914mm)	E2FP-362-	■ ■	2254.29	2400.69	2589.01	3049.31	3356.15	3502.49
	42"(1067mm)	E2FP-4262-	■ ■	2373.93	2527.77	2730.97	3235.91	3572.51	3726.29
	48"(1219mm)	E2FP-462-	■ ■	2491.23	2652.51	2870.59	3420.17	3786.53	3947.75
	60"(1524mm)	E2FP-562-	■ ■	2728.17	2904.33	3152.17	3791.03	4216.91	4393.01
72"(1829mm)	24"(610mm)	E2FP-270-	■ ■	\$2094.09	\$2229.45	\$2395.69	\$2789.75	\$3052.43	\$3187.73
	30"(762mm)	E2FP-3070-	■ ■	2227.17	2370.93	2553.97	2998.43	3294.71	3438.41
	36"(914mm)	E2FP-370-	■ ■	2360.25	2512.41	2712.25	3207.11	3536.99	3689.09
	42"(1067mm)	E2FP-4270-	■ ■	2493.33	2653.89	2870.53	3415.79	3779.27	3939.77
	48"(1219mm)	E2FP-470-	■ ■	2626.41	2795.37	3028.81	3624.47	4021.55	4190.45
	60"(1524mm)	E2FP-570-	■ ■	2892.57	3078.33	3345.37	4041.83	4506.11	4691.81
80"(2032mm)	24"(610mm)	E2FP-278-	■ ■	\$2170.83	\$2310.03	\$2483.95	\$2901.05	\$3179.09	\$3318.23
	30"(762mm)	E2FP-3078-	■ ■	2319.69	2468.25	2660.89	3134.15	3449.63	3598.13
	36"(914mm)	E2FP-378-	■ ■	2466.21	2624.13	2835.49	3364.91	3717.83	3875.69
	42"(1067mm)	E2FP-4278-	■ ■	2612.73	2780.01	3010.09	3595.67	3986.03	4153.25
	48"(1219mm)	E2FP-478-	■ ■	2759.25	2935.89	3184.69	3826.43	4254.23	4430.81
	60"(1524mm)	E2FP-578-	■ ■	3054.63	3249.99	3536.23	4290.29	4792.97	4988.27

This page intentionally blank

Monolithic Panel with Full-Height Inserts — No Power

UniGroup Too

Fabric Inserts

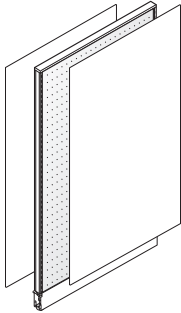

E2LN-B (Non-Powered)

Features

- Includes non-powered full-height panel core assembly, monolithic panel inserts square top cap with aligner, with or without one-piece base raceway cover, 1.6 hinge kits, side trim rails, leveling glides and carpet gripper. .6 top cap end plugs and base raceway end caps are shipped with each panel. Order additional as necessary.
- Acoustical panel surfaces bonded to compressed fiberboard for moderate tackable properties.
- Each insert may have the same fabric or a different fabric.
- Panel thickness is 2"(51mm).
- Base raceway is 4"(102mm) high.
- Shipped with unassembled inserts, top cap, base raceway cover and side trim rails.
- Inserts may easily be changed on installed monolithic panels without components.
- Can be field-modified from full-height monolithic panel insert to segmented panel inserts.

Specification Tips

- Panels will accept add-on panels up to a combined height of 80"(2032mm). For aesthetic consistency, specify UniGroup Too add-on panels.
- Raceway cover must be separately specified for option -BE (no raceway cover).
- If 90° top cap for four-way and 120° top cap for three-way are not specified, additional top cap end plugs will need to be ordered.
- Additional top cap end plugs and base raceway end caps will need to be specified if finish posts are not ordered.

To Order, Specify:

- 1) Product number, including:

① Options:

B With Raceway Cover

BE Without Raceway Cover, deduct **\$98.65** list

- 2) Fabric/colorway for panel insert side one.
- 3) Fabric/colorway for panel insert side two.
- 4) Trim color raceway cover, glide housings and end caps.
- 5) Trim color for top cap and side trim rails.

Note: Upcharge for mixed surface grades, refer to the electronic design and specification tools for pricing.

NOTES:

- Non-powered panels ship without receptacle ports in the base raceway cover.
- Some building codes may restrict the use of panel heights greater than 69"(1753mm). Consult your local code authority to assure that the furniture layout is compliant.
- For International Power, specify non-powered panels and use Power Logic components. See Specification Guide for more information on Power Logic.
- For Chicago power, specify non-powered panels without a base raceway cover and separately specify Chicago power retrofit kit.

Monolithic Panel with Full-Height Inserts — No Power

UniGroup Too

	Actual Height	Width	Number ①	Trim A Fabric Grade						
				A	B	C	E	F	G	
Fabric Inserts	32"(813mm)	24"(610mm)	E2LN-230- FF	\$ 982.35	\$1037.53	\$1100.01	\$1232.41	\$1324.33	\$1379.43	
		30"(762mm)	E2LN-3030- FF	1063.10	1122.26	1189.34	1331.42	1430.06	1489.20	
		36"(914mm)	E2LN-330- FF	1143.85	1206.99	1278.67	1430.43	1535.79	1598.97	
		42"(1067mm)	E2LN-4230- FF	1224.60	1291.72	1368.00	1529.44	1641.52	1708.74	
		48"(1219mm)	E2LN-430- FF	1305.35	1376.45	1457.33	1628.45	1747.25	1818.51	
		60"(1524mm)	E2LN-530- FF	1466.85	1545.91	1635.99	1826.47	1958.71	2038.05	
		40"(1016mm)	24"(610mm)	E2LN-238- FF	\$1072.04	\$1135.82	\$1200.50	\$1343.16	\$1439.14	\$1497.82
			30"(762mm)	E2LN-3038- FF	1174.31	1242.07	1311.35	1463.69	1566.39	1629.11
			36"(914mm)	E2LN-338- FF	1255.06	1326.80	1400.68	1562.70	1672.12	1738.88
			42"(1067mm)	E2LN-4238- FF	1335.81	1411.53	1490.01	1661.71	1777.85	1848.65
			48"(1219mm)	E2LN-438- FF	1416.56	1496.26	1579.34	1760.72	1883.58	1958.42
			60"(1524mm)	E2LN-538- FF	1578.06	1665.72	1758.00	1958.74	2095.04	2177.96
		48"(1219mm)	24"(610mm)	E2LN-246- FF	\$1161.73	\$1234.11	\$1300.99	\$1453.91	\$1553.95	\$1616.21
			30"(762mm)	E2LN-3046- FF	1264.00	1340.36	1411.84	1574.44	1681.20	1747.50
			36"(914mm)	E2LN-346- FF	1344.75	1425.09	1501.17	1673.45	1786.93	1857.27
			42"(1067mm)	E2LN-4246- FF	1425.50	1509.82	1590.50	1772.46	1892.66	1967.04
			48"(1219mm)	E2LN-446- FF	1506.25	1594.55	1679.83	1871.47	1998.39	2076.81
			60"(1524mm)	E2LN-546- FF	1667.75	1764.01	1858.49	2069.49	2209.85	2296.35
		56"(1422mm)	24"(610mm)	E2LN-254- FF	\$1251.42	\$1332.40	\$1401.48	\$1564.66	\$1668.76	\$1734.60
			30"(762mm)	E2LN-3054- FF	1353.69	1438.65	1512.33	1685.19	1796.01	1865.89
			36"(914mm)	E2LN-354- FF	1434.44	1523.38	1601.66	1784.20	1901.74	1975.66
			42"(1067mm)	E2LN-4254- FF	1612.00	1704.92	1787.80	1980.02	2104.28	2182.24
			48"(1219mm)	E2LN-454- FF	1725.02	1821.92	1909.40	2111.30	2242.28	2324.28
			60"(1524mm)	E2LN-554- FF	1951.06	2055.92	2152.60	2373.86	2518.28	2608.36
		64"(1626mm)	24"(610mm)	E2LN-262- FF	\$1341.11	\$1430.69	\$1501.97	\$1675.41	\$1783.57	\$1852.99
			30"(762mm)	E2LN-3062- FF	1443.38	1536.94	1612.82	1795.94	1910.82	1984.28
			36"(914mm)	E2LN-362- FF	1595.87	1693.41	1773.89	1966.69	2088.29	2165.79
			42"(1067mm)	E2LN-4262- FF	1712.49	1814.01	1899.09	2101.57	2229.89	2311.43
			48"(1219mm)	E2LN-462- FF	1829.11	1934.61	2024.29	2236.45	2371.49	2457.07
			60"(1524mm)	E2LN-562- FF	2062.35	2175.81	2274.69	2506.21	2654.69	2748.35
		72"(1829mm)	24"(610mm)	E2LN-270- FF	\$1430.80	\$1528.98	\$1602.46	\$1786.16	\$1898.38	\$1971.38
			30"(762mm)	E2LN-3070- FF	1577.91	1680.07	1758.15	1951.53	2070.47	2147.51
			36"(914mm)	E2LN-370- FF	1703.50	1809.64	1892.32	2095.38	2221.04	2302.12
			42"(1067mm)	E2LN-4270- FF	1829.09	1939.21	2026.49	2239.23	2371.61	2456.73
			48"(1219mm)	E2LN-470- FF	1954.68	2068.78	2160.66	2383.08	2522.18	2611.34
			60"(1524mm)	E2LN-570- FF	2205.86	2327.92	2429.00	2670.78	2823.32	2920.56
		80"(2032mm)	24"(610mm)	E2LN-278- FF	\$1681.93	\$1788.71	\$1864.39	\$2058.35	\$2174.63	\$2251.21
			30"(762mm)	E2LN-3078- FF	1882.85	1993.61	2073.89	2277.53	2400.53	2481.15
			36"(914mm)	E2LN-378- FF	2062.25	2176.99	2261.87	2475.19	2604.91	2689.57
			42"(1067mm)	E2LN-4278- FF	2241.65	2360.37	2449.85	2672.85	2809.29	2897.99
			48"(1219mm)	E2LN-478- FF	2421.05	2543.75	2637.83	2870.51	3013.67	3106.41
			60"(1524mm)	E2LN-578- FF	2779.85	2910.51	3013.79	3265.83	3422.43	3523.25

Monolithic Panel with Full-Height Inserts — No Power

UniGroup Too

	Actual Height	Width	Number ①	Trim B		C	E	F	G
				Fabric	Grade				
Fabric Inserts				A	B				
	32"(813mm)	24"(610mm)	E2LN-230- FF	\$1003.11	\$1058.29	\$1120.77	\$1253.17	\$1345.09	\$1400.19
		30"(762mm)	E2LN-3030- FF	1084.21	1143.37	1210.45	1352.53	1451.17	1510.31
		36"(914mm)	E2LN-330- FF	1165.31	1228.45	1300.13	1451.89	1557.25	1620.43
		42"(1067mm)	E2LN-4230- FF	1246.41	1313.53	1389.81	1551.25	1663.33	1730.55
		48"(1219mm)	E2LN-430- FF	1327.51	1398.61	1479.49	1650.61	1769.41	1840.67
		60"(1524mm)	E2LN-530- FF	1489.71	1568.77	1658.85	1849.33	1981.57	2060.91
	40"(1016mm)	24"(610mm)	E2LN-238- FF	\$1093.70	\$1157.48	\$1222.16	\$1364.82	\$1460.80	\$1519.48
		30"(762mm)	E2LN-3038- FF	1196.32	1264.08	1333.36	1485.70	1588.40	1651.12
		36"(914mm)	E2LN-338- FF	1277.42	1349.16	1423.04	1585.06	1694.48	1761.24
		42"(1067mm)	E2LN-4238- FF	1358.52	1434.24	1512.72	1684.42	1800.56	1871.36
		48"(1219mm)	E2LN-438- FF	1439.62	1519.32	1602.40	1783.78	1906.64	1981.48
		60"(1524mm)	E2LN-538- FF	1601.82	1689.48	1781.76	1982.50	2118.80	2201.72
	48"(1219mm)	24"(610mm)	E2LN-246- FF	\$1184.29	\$1256.67	\$1323.55	\$1476.47	\$1576.51	\$1638.77
		30"(762mm)	E2LN-3046- FF	1286.91	1363.27	1434.75	1597.35	1704.11	1770.41
		36"(914mm)	E2LN-346- FF	1368.01	1448.35	1524.43	1696.71	1810.19	1880.53
		42"(1067mm)	E2LN-4246- FF	1449.11	1533.43	1614.11	1796.07	1916.27	1990.65
		48"(1219mm)	E2LN-446- FF	1530.21	1618.51	1703.79	1895.43	2022.35	2100.77
		60"(1524mm)	E2LN-546- FF	1692.41	1788.67	1883.15	2094.15	2234.51	2321.01
	56"(1422mm)	24"(610mm)	E2LN-254- FF	\$1274.88	\$1355.86	\$1424.94	\$1588.12	\$1692.22	\$1758.06
		30"(762mm)	E2LN-3054- FF	1377.50	1462.46	1536.14	1709.00	1819.82	1889.70
		36"(914mm)	E2LN-354- FF	1458.60	1547.54	1625.82	1808.36	1925.90	1999.82
		42"(1067mm)	E2LN-4254- FF	1636.51	1729.43	1812.31	2004.53	2128.79	2206.75
		48"(1219mm)	E2LN-454- FF	1749.88	1846.78	1934.26	2136.16	2267.14	2349.14
		60"(1524mm)	E2LN-554- FF	1976.62	2081.48	2178.16	2399.42	2543.84	2633.92
	64"(1626mm)	24"(610mm)	E2LN-262- FF	\$1365.47	\$1455.05	\$1526.33	\$1699.77	\$1807.93	\$1877.35
		30"(762mm)	E2LN-3062- FF	1468.09	1561.65	1637.53	1820.65	1935.53	2008.99
		36"(914mm)	E2LN-362- FF	1620.93	1718.47	1798.95	1991.75	2113.35	2190.85
		42"(1067mm)	E2LN-4262- FF	1737.90	1839.42	1924.50	2126.98	2255.30	2336.84
		48"(1219mm)	E2LN-462- FF	1854.87	1960.37	2050.05	2262.21	2397.25	2482.83
		60"(1524mm)	E2LN-562- FF	2088.81	2202.27	2301.15	2532.67	2681.15	2774.81
	72"(1829mm)	24"(610mm)	E2LN-270- FF	\$1456.06	\$1554.24	\$1627.72	\$1811.42	\$1923.64	\$1996.64
		30"(762mm)	E2LN-3070- FF	1603.52	1705.68	1783.76	1977.14	2096.08	2173.12
		36"(914mm)	E2LN-370- FF	1729.46	1835.60	1918.28	2121.34	2247.00	2328.08
		42"(1067mm)	E2LN-4270- FF	1855.40	1965.52	2052.80	2265.54	2397.92	2483.04
		48"(1219mm)	E2LN-470- FF	1981.34	2095.44	2187.32	2409.74	2548.84	2638.00
		60"(1524mm)	E2LN-570- FF	2233.22	2355.28	2456.36	2698.14	2850.68	2947.92
	80"(2032mm)	24"(610mm)	E2LN-278- FF	\$1708.09	\$1814.87	\$1890.55	\$2084.51	\$2200.79	\$2277.37
		30"(762mm)	E2LN-3078- FF	1909.36	2020.12	2100.40	2304.04	2427.04	2507.66
		36"(914mm)	E2LN-378- FF	2089.11	2203.85	2288.73	2502.05	2631.77	2716.43
		42"(1067mm)	E2LN-4278- FF	2268.86	2387.58	2477.06	2700.06	2836.50	2925.20
		48"(1219mm)	E2LN-478- FF	2448.61	2571.31	2665.39	2898.07	3041.23	3133.97
		60"(1524mm)	E2LN-578- FF	2808.11	2938.77	3042.05	3294.09	3450.69	3551.51

This page intentionally blank

Monolithic Panel with Full-Height Inserts — Powered

UniGroup Too

Fabric Inserts

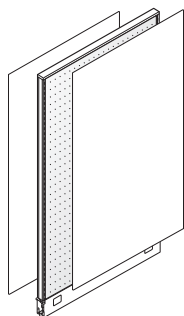

E2LP-B (3-circuit)
E2LP-2 (4-circuit, 2+2)
E2LP-4 (4-circuit, 3+1)



Features

- Includes powered full-height panel core assembly, monolithic panel inserts square top cap with aligner, with or without one-piece base raceway cover, 1.6 hinge kits, side trim rails, leveling glides and carpet gripper; power distribution assembly/flex connector(s). .6 top cap end plugs and base raceway end caps are shipped with each panel. Order additional as necessary.
- Acoustical panel surfaces bonded to compressed fiber board moderate tackable properties.
- Each insert may have the same fabric or a different fabric.
- Panel thickness is 2"(51mm).
- Base raceway is 4"(102mm) high.
- Powered raceway with or without raceway cover requires modified catalog number and list price.
- Powered panels are available for countries that utilize 120 volt 60 hertz electrical systems and U.S. configured plugs and outlets.
- Shipped with unassembled inserts, top cap, base raceway cover and side trim rails.
- Inserts may easily be changed on installed monolithic panels without components.
- Can be field-modified from full-height monolithic panel insert to segmented panel inserts.

Specification Tips

- Panels will accept add-on panels up to a combined height of 80"(2032mm). For aesthetic consistency, specify UniGroup Too add-on panels.
- Flex connectors provided for powered monolithic panels accommodate straight in-line, inside 90°, and inside 120° conditions (if applicable).
- Receptacles for powered panels must be specified separately.
- Raceway cover must be separately specified for option -BE, BYE, 2E, 2YE, 4E or 4YE (no raceway cover).
- If 90° top cap for four-way and 120° top cap for three-way are not specified, additional top cap end plugs will need to be ordered.
- Additional top cap end plugs and base raceway end caps will need to be specified if finish posts are not ordered.

To Order, Specify:

1) Product number, including:

① 3-Circuit

- B** With Raceway Cover
- BE** Without Raceway Cover, deduct **\$127.34** list
- BY** NYC with Raceway Cover
- BYE** NYC without Raceway Cover, deduct **\$127.34** list

4-Circuit, 2+2

- 2** With Raceway Cover
- 2E** Without Raceway Cover, deduct **\$127.34** list
- 2Y** NYC with Raceway Cover
- 2YE** NYC without Raceway Cover, deduct **\$127.34** list

4-Circuit, 3+1

- 4** With Raceway Cover
- 4E** Without Raceway Cover, deduct **\$127.34** list
- 4Y** NYC with Raceway Cover
- 4YE** NYC without Raceway Cover, deduct **\$127.34** list

- 2) Fabric/colorway for panel insert side one.
- 3) Fabric/colorway for panel insert side two.
- 4) Trim color raceway cover, glide housings and end caps.
- 5) Trim color for top cap and side trim rails.

Note: Upcharge for mixed surface grades, refer to the electronic design and specification tools for pricing.

NOTES:

- Powered panels with raceway covers ship with receptacle ports in the base raceway cover. Receptacle ports on the raceway cover measure 2.35"(60mm) top-to-bottom and 2.88"(73mm) side-to-side.
- Powered panels with Power Distribution Assemblies (PDA) but without raceway covers require separately specified base raceway covers for power and communication port locations other than the standard powered base raceway cover.
- New York City (NYC) electrical applications require field installation of PDA.
- New York Port Authority (NYPA) electrical applications require metal raceway covers. To order, specify NYC powered panels without raceway cover and separately specify metal covers through Haworth e-Parts.
- Some building codes may restrict the use of panel heights greater than 69"(1753mm). Consult your local code authority to assure that the furniture layout is compliant.
- For International Power, specify non-powered panels and use Power Logic components. See Specification Guide for more information on Power Logic.
- For Chicago power, specify non-powered panels without a base raceway cover and separately specify Chicago power retrofit kit.

Monolithic Panel with Full-Height Inserts — Powered

UniGroup Too

	Actual Height	Width	Number ①	Trim A Fabric Grade					
				A	B	C	E	F	G
Fabric Inserts	32"(813mm)	24"(610mm)	E2LP-230- FF	\$1417.83	\$1473.01	\$1535.49	\$1667.89	\$1759.81	\$1814.91
	30"(762mm)	E2LP-3030- FF	1498.58	1557.74	1624.82	1766.90	1865.54	1924.68	
	36"(914mm)	E2LP-330- FF	1579.33	1642.47	1714.15	1865.91	1971.27	2034.45	
	42"(1067mm)	E2LP-4230- FF	1660.08	1727.20	1803.48	1964.92	2077.00	2144.22	
	48"(1219mm)	E2LP-430- FF	1740.83	1811.93	1892.81	2063.93	2182.73	2253.99	
	60"(1524mm)	E2LP-530- FF	1902.33	1981.39	2071.47	2261.95	2394.19	2473.53	
	40"(1016mm)	24"(610mm)	E2LP-238- FF	\$1507.52	\$1571.30	\$1635.98	\$1778.64	\$1874.62	\$1933.30
	30"(762mm)	E2LP-3038- FF	1609.79	1677.55	1746.83	1899.17	2001.87	2064.59	
	36"(914mm)	E2LP-338- FF	1690.54	1762.28	1836.16	1998.18	2107.60	2174.36	
	42"(1067mm)	E2LP-4238- FF	1771.29	1847.01	1925.49	2097.19	2213.33	2284.13	
	48"(1219mm)	E2LP-438- FF	1852.04	1931.74	2014.82	2196.20	2319.06	2393.90	
	60"(1524mm)	E2LP-538- FF	2013.54	2101.20	2193.48	2394.22	2530.52	2613.44	
	48"(1219mm)	24"(610mm)	E2LP-246- FF	\$1597.21	\$1669.59	\$1736.47	\$1889.39	\$1989.43	\$2051.69
	30"(762mm)	E2LP-3046- FF	1699.48	1775.84	1847.32	2009.92	2116.68	2182.98	
	36"(914mm)	E2LP-346- FF	1780.23	1860.57	1936.65	2108.93	2222.41	2292.75	
	42"(1067mm)	E2LP-4246- FF	1860.98	1945.30	2025.98	2207.94	2328.14	2402.52	
	48"(1219mm)	E2LP-446- FF	1941.73	2030.03	2115.31	2306.95	2433.87	2512.29	
	60"(1524mm)	E2LP-546- FF	2103.23	2199.49	2293.97	2504.97	2645.33	2731.83	
	56"(1422mm)	24"(610mm)	E2LP-254- FF	\$1686.90	\$1767.88	\$1836.96	\$2000.14	\$2104.24	\$2170.08
	30"(762mm)	E2LP-3054- FF	1789.17	1874.13	1947.81	2120.67	2231.49	2301.37	
	36"(914mm)	E2LP-354- FF	1869.92	1958.86	2037.14	2219.68	2337.22	2411.14	
	42"(1067mm)	E2LP-4254- FF	2047.48	2140.40	2223.28	2415.50	2539.76	2617.72	
	48"(1219mm)	E2LP-454- FF	2160.50	2257.40	2344.88	2546.78	2677.76	2759.76	
	60"(1524mm)	E2LP-554- FF	2386.54	2491.40	2588.08	2809.34	2953.76	3043.84	
64"(1626mm)	24"(610mm)	E2LP-262- FF	\$1776.59	\$1866.17	\$1937.45	\$2110.89	\$2219.05	\$2288.47	
30"(762mm)	E2LP-3062- FF	1878.86	1972.42	2048.30	2231.42	2346.30	2419.76		
36"(914mm)	E2LP-362- FF	2031.35	2128.89	2209.37	2402.17	2523.77	2601.27		
42"(1067mm)	E2LP-4262- FF	2147.97	2249.49	2334.57	2537.05	2665.37	2746.91		
48"(1219mm)	E2LP-462- FF	2264.59	2370.09	2459.77	2671.93	2806.97	2892.55		
60"(1524mm)	E2LP-562- FF	2497.83	2611.29	2710.17	2941.69	3090.17	3183.83		
72"(1829mm)	24"(610mm)	E2LP-270- FF	\$1866.28	\$1964.46	\$2037.94	\$2221.64	\$2333.86	\$2406.86	
30"(762mm)	E2LP-3070- FF	2013.39	2115.55	2193.63	2387.01	2505.95	2582.99		
36"(914mm)	E2LP-370- FF	2138.98	2245.12	2327.80	2530.86	2656.52	2737.60		
42"(1067mm)	E2LP-4270- FF	2264.57	2374.69	2461.97	2674.71	2807.09	2892.21		
48"(1219mm)	E2LP-470- FF	2390.16	2504.26	2596.14	2818.56	2957.66	3046.82		
60"(1524mm)	E2LP-570- FF	2641.34	2763.40	2864.48	3106.26	3258.80	3356.04		
80"(2032mm)	24"(610mm)	E2LP-278- FF	\$2117.41	\$2224.19	\$2299.87	\$2493.83	\$2610.11	\$2686.69	
30"(762mm)	E2LP-3078- FF	2318.33	2429.09	2509.37	2713.01	2836.01	2916.63		
36"(914mm)	E2LP-378- FF	2497.73	2612.47	2697.35	2910.67	3040.39	3125.05		
42"(1067mm)	E2LP-4278- FF	2677.13	2795.85	2885.33	3108.33	3244.77	3333.47		
48"(1219mm)	E2LP-478- FF	2856.53	2979.23	3073.31	3305.99	3449.15	3541.89		
60"(1524mm)	E2LP-578- FF	3215.33	3345.99	3449.27	3701.31	3857.91	3958.73		

Monolithic Panel with Full-Height Inserts — Powered

UniGroup Too

	Actual Height	Width	Number ①	Trim B		C	E	F	G
				Fabric Grade A	B				
Fabric Inserts	32"(813mm)	24"(610mm)	E2LP-230- FF	\$1438.59	\$1493.77	\$1556.25	\$1688.65	\$1780.57	\$1835.67
	30"(762mm)	E2LP-3030- FF	1519.69	1578.85	1645.93	1788.01	1886.65	1945.79	
	36"(914mm)	E2LP-330- FF	1600.79	1663.93	1735.61	1887.37	1992.73	2055.91	
	42"(1067mm)	E2LP-4230- FF	1681.89	1749.01	1825.29	1986.73	2098.81	2166.03	
	48"(1219mm)	E2LP-430- FF	1762.99	1834.09	1914.97	2086.09	2204.89	2276.15	
	60"(1524mm)	E2LP-530- FF	1925.19	2004.25	2094.33	2284.81	2417.05	2496.39	
	40"(1016mm)	24"(610mm)	E2LP-238- FF	\$1529.18	\$1592.96	\$1657.64	\$1800.30	\$1896.28	\$1954.96
	30"(762mm)	E2LP-3038- FF	1631.80	1699.56	1768.84	1921.18	2023.88	2086.60	
	36"(914mm)	E2LP-338- FF	1712.90	1784.64	1858.52	2020.54	2129.96	2196.72	
	42"(1067mm)	E2LP-4238- FF	1794.00	1869.72	1948.20	2119.90	2236.04	2306.84	
	48"(1219mm)	E2LP-438- FF	1875.10	1954.80	2037.88	2219.26	2342.12	2416.96	
	60"(1524mm)	E2LP-538- FF	2037.30	2124.96	2217.24	2417.98	2554.28	2637.20	
	48"(1219mm)	24"(610mm)	E2LP-246- FF	\$1619.77	\$1692.15	\$1759.03	\$1911.95	\$2011.99	\$2074.25
	30"(762mm)	E2LP-3046- FF	1722.39	1798.75	1870.23	2032.83	2139.59	2205.89	
	36"(914mm)	E2LP-346- FF	1803.49	1883.83	1959.91	2132.19	2245.67	2316.01	
	42"(1067mm)	E2LP-4246- FF	1884.59	1968.91	2049.59	2231.55	2351.75	2426.13	
	48"(1219mm)	E2LP-446- FF	1965.69	2053.99	2139.27	2330.91	2457.83	2536.25	
	60"(1524mm)	E2LP-546- FF	2127.89	2224.15	2318.63	2529.63	2669.99	2756.49	
	56"(1422mm)	24"(610mm)	E2LP-254- FF	\$1710.36	\$1791.34	\$1860.42	\$2023.60	\$2127.70	\$2193.54
	30"(762mm)	E2LP-3054- FF	1812.98	1897.94	1971.62	2144.48	2255.30	2325.18	
	36"(914mm)	E2LP-354- FF	1894.08	1983.02	2061.30	2243.84	2361.38	2435.30	
	42"(1067mm)	E2LP-4254- FF	2071.99	2164.91	2247.79	2440.01	2564.27	2642.23	
	48"(1219mm)	E2LP-454- FF	2185.36	2282.26	2369.74	2571.64	2702.62	2784.62	
	60"(1524mm)	E2LP-554- FF	2412.10	2516.96	2613.64	2834.90	2979.32	3069.40	
	64"(1626mm)	24"(610mm)	E2LP-262- FF	\$1800.95	\$1890.53	\$1961.81	\$2135.25	\$2243.41	\$2312.83
	30"(762mm)	E2LP-3062- FF	1903.57	1997.13	2073.01	2256.13	2371.01	2444.47	
	36"(914mm)	E2LP-362- FF	2056.41	2153.95	2234.43	2427.23	2548.83	2626.33	
	42"(1067mm)	E2LP-4262- FF	2173.38	2274.90	2359.98	2562.46	2690.78	2772.32	
	48"(1219mm)	E2LP-462- FF	2290.35	2395.85	2485.53	2697.69	2832.73	2918.31	
	60"(1524mm)	E2LP-562- FF	2524.29	2637.75	2736.63	2968.15	3116.63	3210.29	
	72"(1829mm)	24"(610mm)	E2LP-270- FF	\$1891.54	\$1989.72	\$2063.20	\$2246.90	\$2359.12	\$2432.12
	30"(762mm)	E2LP-3070- FF	2039.00	2141.16	2219.24	2412.62	2531.56	2608.60	
	36"(914mm)	E2LP-370- FF	2164.94	2271.08	2353.76	2556.82	2682.48	2763.56	
	42"(1067mm)	E2LP-4270- FF	2290.88	2401.00	2488.28	2701.02	2833.40	2918.52	
	48"(1219mm)	E2LP-470- FF	2416.82	2530.92	2622.80	2845.22	2984.32	3073.48	
	60"(1524mm)	E2LP-570- FF	2668.70	2790.76	2891.84	3133.62	3286.16	3383.40	
	80"(2032mm)	24"(610mm)	E2LP-278- FF	\$2143.57	\$2250.35	\$2326.03	\$2519.99	\$2636.27	\$2712.85
	30"(762mm)	E2LP-3078- FF	2344.84	2455.60	2535.88	2739.52	2862.52	2943.14	
	36"(914mm)	E2LP-378- FF	2524.59	2639.33	2724.21	2937.53	3067.25	3151.91	
	42"(1067mm)	E2LP-4278- FF	2704.34	2823.06	2912.54	3135.54	3271.98	3360.68	
	48"(1219mm)	E2LP-478- FF	2884.09	3006.79	3100.87	3333.55	3476.71	3569.45	
	60"(1524mm)	E2LP-578- FF	3243.59	3374.25	3477.53	3729.57	3886.17	3986.99	

This page intentionally blank

Monolithic Panel with Segmented Inserts — No Power

UniGroup Too

Fabric Inserts

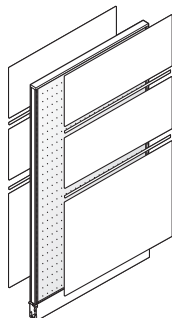

E25N-B (Non-Powered)

Features

- Includes non-powered full-height panel core assembly, segmented panel inserts and trim strips, square top cap with aligner, with or without one-piece base raceway cover, 1.6 hinge kits, side trim rails, leveling glides and carpet gripper. .6 top cap end plugs and base raceway end caps are shipped with each panel. Order additional as necessary.
- Acoustical panel surfaces bonded to compressed fiber board for moderate tackable properties.
- Panel surfaces may have the same fabric on both sides or a different fabric on each side.
- Panel thickness is 2"(51mm).
- Base raceway is 4"(102mm) high.
- Shipped with unassembled inserts, top cap, base raceway cover side trim rails.
- Inserts may easily be changed on installed monolithic panels without components.
- Refer to the Panel Configuration Options chart in Specification Guide for panel and insert heights (nominal vs. actual) and insert configurations.

Specification Tips

- Panels will accept add-on panels up to a combined height of 80"(2032mm). For aesthetic consistency, specify UniGroup Too add-on panels.
- Raceway cover must be separately specified for option -BE (no raceway cover).
- If 90° top cap for four-way and 120° top cap for three-way are not specified, additional top cap end plugs will need to be ordered.
- Additional top cap end plugs and base raceway end caps will need to be specified if finish posts are not ordered.

To Order, Specify:

- 1) Product number, including:

① Options:

B With Raceway Cover

BE Without Raceway Cover, deduct **\$98.65** list

- 2) Fabric/colorway for panel insert side one.
- 3) Fabric/colorway for panel insert side two.
- 4) Trim color raceway cover, glide housings and end caps.
- 5) Trim color for top cap, side trim rails and trim strip(s) for panel insert.

Note: Upcharge for mixed surface grades, refer to the electronic design and specification tools for pricing.

NOTES:

- Non-powered panels ship without receptacle ports in the base raceway cover.
- Some building codes may restrict the use of panel heights greater than 69"(1753mm). Consult your local code authority to assure that the furniture layout is compliant.
- For International Power, specify non-powered panels and use Power Logic components. See Specification Guide for more information on Power Logic.

Monolithic Panel with Segmented Inserts — No Power

UniGroup Too

	Actual Height	Width	Number ①	Trim A Fabric Grade						
				A	B	C	E	F	G	
Fabric Inserts	40"(1016mm)	24"(610mm)	E2SN-238- FF	\$1116.90	\$1187.36	\$1259.64	\$1418.54	\$1525.66	\$1591.10	
		30"(762mm)	E2SN-3038- FF	1263.99	1345.17	1429.65	1614.41	1739.45	1815.69	
		36"(914mm)	E2SN-338- FF	1389.56	1481.46	1578.14	1788.76	1931.72	2018.76	
		42"(1067mm)	E2SN-4238- FF	1515.13	1617.75	1726.63	1963.11	2123.99	2221.83	
		48"(1219mm)	E2SN-438- FF	1640.70	1754.04	1875.12	2137.46	2316.26	2424.90	
		60"(1524mm)	E2SN-538- FF	1891.84	2026.62	2172.10	2486.16	2700.80	2831.04	
		48"(1219mm)	24"(610mm)	E2SN-246- FF	\$1215.55	\$1295.93	\$1371.93	\$1544.35	\$1657.77	\$1728.13
			30"(762mm)	E2SN-3046- FF	1362.64	1453.74	1541.94	1740.22	1871.56	1952.72
			36"(914mm)	E2SN-346- FF	1488.21	1590.03	1690.43	1914.57	2063.83	2155.79
			42"(1067mm)	E2SN-4246- FF	1613.78	1726.32	1838.92	2088.92	2256.10	2358.86
			48"(1219mm)	E2SN-446- FF	1739.35	1862.61	1987.41	2263.27	2448.37	2561.93
			60"(1524mm)	E2SN-546- FF	1990.49	2135.19	2284.39	2611.97	2832.91	2968.07
		56"(1422mm)	24"(610mm)	E2SN-254- FF	\$1475.64	\$1565.94	\$1645.66	\$1831.60	\$1951.32	\$2026.60
			30"(762mm)	E2SN-3054- FF	1622.73	1723.75	1815.67	2027.47	2165.11	2251.19
			36"(914mm)	E2SN-354- FF	1748.30	1860.04	1964.16	2201.82	2357.38	2454.26
			42"(1067mm)	E2SN-4254- FF	1970.68	2093.14	2209.46	2472.98	2646.46	2754.14
			48"(1219mm)	E2SN-454- FF	2128.52	2261.70	2390.22	2679.60	2871.00	2989.48
			60"(1524mm)	E2SN-554- FF	2444.20	2598.82	2751.74	3092.84	3320.08	3460.16
		64"(1626mm)	24"(610mm)	E2SN-262- FF	\$1574.29	\$1674.51	\$1757.95	\$1957.41	\$2083.43	\$2163.63
			30"(762mm)	E2SN-3062- FF	1721.38	1832.32	1927.96	2153.28	2297.22	2388.22
			36"(914mm)	E2SN-362- FF	2076.00	2197.66	2305.50	2556.68	2718.54	2820.34
			42"(1067mm)	E2SN-4262- FF	2080.13	2212.51	2332.55	2609.59	2789.37	2901.97
			48"(1219mm)	E2SN-462- FF	2241.57	2384.67	2516.91	2819.81	3017.51	3140.91
			60"(1524mm)	E2SN-562- FF	2564.45	2728.99	2885.63	3240.25	3473.79	3618.79
		72"(1829mm)	24"(610mm)	E2SN-270- FF	\$1672.94	\$1783.08	\$1870.24	\$2083.22	\$2215.54	\$2300.66
			30"(762mm)	E2SN-3070- FF	1864.87	1985.73	2085.09	2323.93	2474.17	2570.09
			36"(914mm)	E2SN-370- FF	2035.28	2166.86	2278.42	2543.12	2711.28	2818.00
			42"(1067mm)	E2SN-4270- FF	2205.69	2347.99	2471.75	2762.31	2948.39	3065.91
			48"(1219mm)	E2SN-470- FF	2376.10	2529.12	2665.08	2981.50	3185.50	3313.82
			60"(1524mm)	E2SN-570- FF	2716.92	2891.38	3051.74	3419.88	3659.72	3809.64
		80"(2032mm)	24"(610mm)	E2SN-278- FF	\$1933.03	\$2053.09	\$2143.97	\$2370.47	\$2509.09	\$2599.13
			30"(762mm)	E2SN-3078- FF	2178.77	2309.55	2412.63	2664.99	2821.53	2922.37
			36"(914mm)	E2SN-378- FF	2402.99	2544.49	2659.77	2937.99	3112.45	3224.09
			42"(1067mm)	E2SN-4278- FF	2627.21	2779.43	2906.91	3210.99	3403.37	3525.81
			48"(1219mm)	E2SN-478- FF	2851.43	3014.37	3154.05	3483.99	3694.29	3827.53
			60"(1524mm)	E2SN-578- FF	3299.87	3484.25	3648.33	4029.99	4276.13	4430.97

Monolithic Panel with Segmented Inserts — No Power

UniGroup Too

	Actual Height	Width	Number ①	Trim B Fabric Grade					
				A	B	C	E	F	G
Fabric Inserts	40"(1016mm)	24"(610mm)	E2SN-238- FF	\$1138.56	\$1209.02	\$1281.30	\$1440.20	\$1547.32	\$1612.76
		30"(762mm)	E2SN-3038- FF	1286.00	1367.18	1451.66	1636.42	1761.46	1837.70
		36"(914mm)	E2SN-338- FF	1411.92	1503.82	1600.50	1811.12	1954.08	2041.12
		42"(1067mm)	E2SN-4238- FF	1537.84	1640.46	1749.34	1985.82	2146.70	2244.54
		48"(1219mm)	E2SN-438- FF	1663.76	1777.10	1898.18	2160.52	2339.32	2447.96
		60"(1524mm)	E2SN-538- FF	1915.60	2050.38	2195.86	2509.92	2724.56	2854.80
	48"(1219mm)	24"(610mm)	E2SN-246- FF	\$1238.11	\$1318.49	\$1394.49	\$1566.91	\$1680.33	\$1750.69
		30"(762mm)	E2SN-3046- FF	1385.55	1476.65	1564.85	1763.13	1894.47	1975.63
		36"(914mm)	E2SN-346- FF	1511.47	1613.29	1713.69	1937.83	2087.09	2179.05
		42"(1067mm)	E2SN-4246- FF	1637.39	1749.93	1862.53	2112.53	2279.71	2382.47
		48"(1219mm)	E2SN-446- FF	1763.31	1886.57	2011.37	2287.23	2472.33	2585.89
		60"(1524mm)	E2SN-546- FF	2015.15	2159.85	2309.05	2636.63	2857.57	2992.73
	56"(1422mm)	24"(610mm)	E2SN-254- FF	\$1499.10	\$1589.40	\$1669.12	\$1855.06	\$1974.78	\$2050.06
		30"(762mm)	E2SN-3054- FF	1646.54	1747.56	1839.48	2051.28	2188.92	2275.00
		36"(914mm)	E2SN-354- FF	1772.46	1884.20	1988.32	2225.98	2381.54	2478.42
		42"(1067mm)	E2SN-4254- FF	1995.19	2117.65	2233.97	2497.49	2670.97	2778.65
		48"(1219mm)	E2SN-454- FF	2153.38	2286.56	2415.08	2704.46	2895.86	3014.34
		60"(1524mm)	E2SN-554- FF	2469.76	2624.38	2777.30	3118.40	3345.64	3485.72
	64"(1626mm)	24"(610mm)	E2SN-262- FF	\$1598.65	\$1698.87	\$1782.31	\$1981.77	\$2107.79	\$2187.99
		30"(762mm)	E2SN-3062- FF	1746.09	1857.03	1952.67	2177.99	2321.93	2412.93
		36"(914mm)	E2SN-362- FF	2101.06	2222.72	2330.56	2581.74	2743.60	2845.40
		42"(1067mm)	E2SN-4262- FF	2105.54	2237.92	2357.96	2635.00	2814.78	2927.38
		48"(1219mm)	E2SN-462- FF	2267.33	2410.43	2542.67	2845.57	3043.27	3166.67
		60"(1524mm)	E2SN-562- FF	2590.91	2755.45	2912.09	3266.71	3500.25	3645.25
72"(1829mm)	24"(610mm)	E2SN-270- FF	\$1698.20	\$1808.34	\$1895.50	\$2108.48	\$2240.80	\$2325.92	
	30"(762mm)	E2SN-3070- FF	1890.48	2011.34	2110.70	2349.54	2499.78	2595.70	
	36"(914mm)	E2SN-370- FF	2061.24	2192.82	2304.38	2569.08	2737.24	2843.96	
	42"(1067mm)	E2SN-4270- FF	2232.00	2374.30	2498.06	2788.62	2974.70	3092.22	
	48"(1219mm)	E2SN-470- FF	2402.76	2555.78	2691.74	3008.16	3212.16	3340.48	
	60"(1524mm)	E2SN-570- FF	2744.28	2918.74	3079.10	3447.24	3687.08	3837.00	
80"(2032mm)	24"(610mm)	E2SN-278- FF	\$1959.19	\$2079.25	\$2170.13	\$2396.63	\$2535.25	\$2625.29	
	30"(762mm)	E2SN-3078- FF	2205.28	2336.06	2439.14	2691.50	2848.04	2948.88	
	36"(914mm)	E2SN-378- FF	2429.85	2571.35	2686.63	2964.85	3139.31	3250.95	
	42"(1067mm)	E2SN-4278- FF	2654.42	2806.64	2934.12	3238.20	3430.58	3553.02	
	48"(1219mm)	E2SN-478- FF	2878.99	3041.93	3181.61	3511.55	3721.85	3855.09	
	60"(1524mm)	E2SN-578- FF	3328.13	3512.51	3676.59	4058.25	4304.39	4459.23	

This page intentionally blank

Monolithic Panel with Segmented Inserts — Powered

UniGroup Too

Fabric Inserts

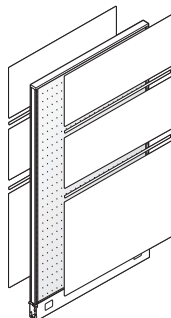

E2SP-B (3-circuit)
E2SP-2 (4-circuit, 2+2)
E2SP-4 (4-circuit, 3+1)



Features

- Includes powered full-height panel core assembly, segmented panel inserts and trim strips, square top cap with aligner, with or without one-piece base raceway cover, 1.6 hinge kits, side trim rails, leveling glides and carpet gripper; power distribution assembly/flex connector(s). .6 top cap end plugs and base raceway end caps are shipped with each panel. Order additional as necessary.
- Acoustical panel surfaces bonded to compressed fiber board for moderate tackable properties.
- Panel surfaces may have the same fabric on both sides or a different fabric on each side.
- Panel thickness is 2”(51mm).
- Base raceway is 4”(102mm) high.
- Powered raceway with or without raceway cover requires modified catalog number and list price.
- Powered panels are available for countries that utilize 120 volt 60 hertz electrical systems and U.S. configured plugs and outlets.
- Shipped with unassembled inserts, top cap, base raceway cover side trim rails.
- Inserts may easily be changed on installed monolithic panels without components.
- Refer to the Panel Configuration Options chart in Specification Guide for panel and insert heights (nominal vs. actual) and insert configurations.

Specification Tips

- Panels will accept add-on panels up to a combined height of 80”(2032mm). For aesthetic consistency, specify UniGroup Too add-on panels.
- Flex connectors provided for powered monolithic panels accommodate straight in-line, inside 90°, and inside 120° conditions (if applicable).
- Receptacles for powered panels must be specified separately.
- Raceway cover must be separately specified for option -BE, BYE, 2E, 2YE, 4E or 4YE (no raceway cover).
- If 90° top cap for four-way and 120° top cap for three-way are not specified, additional top cap end plugs will need to be ordered.
- Additional top cap end plugs and base raceway end caps will need to be specified if finish posts are not ordered.

To Order, Specify:

1) Product number, including:

① 3-Circuit

- B** With Raceway Cover
- BE** Without Raceway Cover, deduct **\$127.34** list
- BY** NYC with Raceway Cover
- BYE** NYC without Raceway Cover, deduct **\$127.34** list

4-Circuit, 2+2

- 2** With Raceway Cover
- 2E** Without Raceway Cover, deduct **\$127.34** list
- 2Y** NYC with Raceway Cover
- 2YE** NYC without Raceway Cover, deduct **\$127.34** list

4-Circuit, 3+1

- 4** With Raceway Cover
- 4E** Without Raceway Cover, deduct **\$127.34** list
- 4Y** NYC with Raceway Cover
- 4YE** NYC without Raceway Cover, deduct **\$127.34** list

- 2) Fabric/colorway for panel insert side one.
- 3) Fabric/colorway for panel insert side two.
- 4) Trim color raceway cover, glide housings and end caps.
- 5) Trim color for top cap, side trim rails and trim strip(s) for panel insert.

Note: Upcharge for mixed surface grades, refer to the electronic design and specification tools for pricing.

NOTES:

- Powered panels with raceway covers ship with receptacle ports in the base raceway cover. Receptacle ports on the raceway cover measure 2.35”(60mm) top-to-bottom and 2.88”(73mm) side-to-side.
- Powered panels with Power Distribution Assemblies (PDA) but without raceway covers require separately specified base raceway covers for power and communication port locations other than the standard powered base raceway cover.
- New York City (NYC) electrical applications require field installation of PDA.
- New York Port Authority (NYPA) electrical applications require metal raceway covers. To order, specify NYC powered panels without raceway cover and separately specify metal covers through Haworth e-Parts.
- Some building codes may restrict the use of panel heights greater than 69”(1753mm). Consult your local code authority to assure that the furniture layout is compliant.
- For International Power, specify non-powered panels and use Power Logic components. See Specification Guide for more information on Power Logic.
- For Chicago power, specify non-powered panels without a base raceway cover and separately specify Chicago power retrofit kit.

Monolithic Panel with Segmented Inserts — Powered

UniGroup Too

	Actual Height	Width	Number ①	Trim A Fabric Grade					
				A	B	C	E	F	G
Fabric Inserts	40"(1016mm)	24"(610mm)	E2SP-238-■ ■ FF	\$1552.38	\$1622.84	\$1695.12	\$1854.02	\$1961.14	\$2026.58
		30"(762mm)	E2SP-3038-■ ■ FF	1699.47	1780.65	1865.13	2049.89	2174.93	2251.17
		36"(914mm)	E2SP-338-■ ■ FF	1825.04	1916.94	2013.62	2224.24	2367.20	2454.24
		42"(1067mm)	E2SP-4238-■ ■ FF	1950.61	2053.23	2162.11	2398.59	2559.47	2657.31
		48"(1219mm)	E2SP-438-■ ■ FF	2076.18	2189.52	2310.60	2572.94	2751.74	2860.38
		60"(1524mm)	E2SP-538-■ ■ FF	2327.32	2462.10	2607.58	2921.64	3136.28	3266.52
	48"(1219mm)	24"(610mm)	E2SP-246-■ ■ FF	\$1651.03	\$1731.41	\$1807.41	\$1979.83	\$2093.25	\$2163.61
		30"(762mm)	E2SP-3046-■ ■ FF	1798.12	1889.22	1977.42	2175.70	2307.04	2388.20
		36"(914mm)	E2SP-346-■ ■ FF	1923.69	2025.51	2125.91	2350.05	2499.31	2591.27
		42"(1067mm)	E2SP-4246-■ ■ FF	2049.26	2161.80	2274.40	2524.40	2691.58	2794.34
		48"(1219mm)	E2SP-446-■ ■ FF	2174.83	2298.09	2422.89	2698.75	2883.85	2997.41
		60"(1524mm)	E2SP-546-■ ■ FF	2425.97	2570.67	2719.87	3047.45	3268.39	3403.55
	56"(1422mm)	24"(610mm)	E2SP-254-■ ■ FF	\$1911.12	\$2001.42	\$2081.14	\$2267.08	\$2386.80	\$2462.08
		30"(762mm)	E2SP-3054-■ ■ FF	2058.21	2159.23	2251.15	2462.95	2600.59	2686.67
		36"(914mm)	E2SP-354-■ ■ FF	2183.78	2295.52	2399.64	2637.30	2792.86	2889.74
		42"(1067mm)	E2SP-4254-■ ■ FF	2406.16	2528.62	2644.94	2908.46	3081.94	3189.62
		48"(1219mm)	E2SP-454-■ ■ FF	2564.00	2697.18	2825.70	3115.08	3306.48	3424.96
		60"(1524mm)	E2SP-554-■ ■ FF	2879.68	3034.30	3187.22	3528.32	3755.56	3895.64
	64"(1626mm)	24"(610mm)	E2SP-262-■ ■ FF	\$2009.77	\$2109.99	\$2193.43	\$2392.89	\$2518.91	\$2599.11
		30"(762mm)	E2SP-3062-■ ■ FF	2156.86	2267.80	2363.44	2588.76	2732.70	2823.70
		36"(914mm)	E2SP-362-■ ■ FF	2511.48	2633.14	2740.98	2992.16	3154.02	3255.82
		42"(1067mm)	E2SP-4262-■ ■ FF	2515.61	2647.99	2768.03	3045.07	3224.85	3337.45
		48"(1219mm)	E2SP-462-■ ■ FF	2677.05	2820.15	2952.39	3255.29	3452.99	3576.39
		60"(1524mm)	E2SP-562-■ ■ FF	2999.93	3164.47	3321.11	3675.73	3909.27	4054.27
72"(1829mm)	24"(610mm)	E2SP-270-■ ■ FF	\$2108.42	\$2218.56	\$2305.72	\$2518.70	\$2651.02	\$2736.14	
	30"(762mm)	E2SP-3070-■ ■ FF	2300.35	2421.21	2520.57	2759.41	2909.65	3005.57	
	36"(914mm)	E2SP-370-■ ■ FF	2470.76	2602.34	2713.90	2978.60	3146.76	3253.48	
	42"(1067mm)	E2SP-4270-■ ■ FF	2641.17	2783.47	2907.23	3197.79	3383.87	3501.39	
	48"(1219mm)	E2SP-470-■ ■ FF	2811.58	2964.60	3100.56	3416.98	3620.98	3749.30	
	60"(1524mm)	E2SP-570-■ ■ FF	3152.40	3326.86	3487.22	3855.36	4095.20	4245.12	
80"(2032mm)	24"(610mm)	E2SP-278-■ ■ FF	\$2368.51	\$2488.57	\$2579.45	\$2805.95	\$2944.57	\$3034.61	
	30"(762mm)	E2SP-3078-■ ■ FF	2614.25	2745.03	2848.11	3100.47	3257.01	3357.85	
	36"(914mm)	E2SP-378-■ ■ FF	2838.47	2979.97	3095.25	3373.47	3547.93	3659.57	
	42"(1067mm)	E2SP-4278-■ ■ FF	3062.69	3214.91	3342.39	3646.47	3838.85	3961.29	
	48"(1219mm)	E2SP-478-■ ■ FF	3286.91	3449.85	3589.53	3919.47	4129.77	4263.01	
	60"(1524mm)	E2SP-578-■ ■ FF	3735.35	3919.73	4083.81	4465.47	4711.61	4866.45	

Monolithic Panel with Segmented Inserts — Powered

UniGroup Too

	Actual Height	Width	Number ①	Trim B Fabric Grade					
				A	B	C	E	F	G
Fabric Inserts	40"(1016mm)	24"(610mm)	E2SP-238-■ ■ FF	\$1574.04	\$1644.50	\$1716.78	\$1875.68	\$1982.80	\$2048.24
		30"(762mm)	E2SP-3038-■ ■ FF	1721.48	1802.66	1887.14	2071.90	2196.94	2273.18
		36"(914mm)	E2SP-338-■ ■ FF	1847.40	1939.30	2035.98	2246.60	2389.56	2476.60
		42"(1067mm)	E2SP-4238-■ ■ FF	1973.32	2075.94	2184.82	2421.30	2582.18	2680.02
		48"(1219mm)	E2SP-438-■ ■ FF	2099.24	2212.58	2333.66	2596.00	2774.80	2883.44
		60"(1524mm)	E2SP-538-■ ■ FF	2351.08	2485.86	2631.34	2945.40	3160.04	3290.28
	48"(1219mm)	24"(610mm)	E2SP-246-■ ■ FF	\$1673.59	\$1753.97	\$1829.97	\$2002.39	\$2115.81	\$2186.17
		30"(762mm)	E2SP-3046-■ ■ FF	1821.03	1912.13	2000.33	2198.61	2329.95	2411.11
		36"(914mm)	E2SP-346-■ ■ FF	1946.95	2048.77	2149.17	2373.31	2522.57	2614.53
		42"(1067mm)	E2SP-4246-■ ■ FF	2072.87	2185.41	2298.01	2548.01	2715.19	2817.95
		48"(1219mm)	E2SP-446-■ ■ FF	2198.79	2322.05	2446.85	2722.71	2907.81	3021.37
		60"(1524mm)	E2SP-546-■ ■ FF	2450.63	2595.33	2744.53	3072.11	3293.05	3428.21
	56"(1422mm)	24"(610mm)	E2SP-254-■ ■ FF	\$1934.58	\$2024.88	\$2104.60	\$2290.54	\$2410.26	\$2485.54
		30"(762mm)	E2SP-3054-■ ■ FF	2082.02	2183.04	2274.96	2486.76	2624.40	2710.48
		36"(914mm)	E2SP-354-■ ■ FF	2207.94	2319.68	2423.80	2661.46	2817.02	2913.90
		42"(1067mm)	E2SP-4254-■ ■ FF	2430.67	2553.13	2669.45	2932.97	3106.45	3214.13
		48"(1219mm)	E2SP-454-■ ■ FF	2588.86	2722.04	2850.56	3139.94	3331.34	3449.82
		60"(1524mm)	E2SP-554-■ ■ FF	2905.24	3059.86	3212.78	3553.88	3781.12	3921.20
	64"(1626mm)	24"(610mm)	E2SP-262-■ ■ FF	\$2034.13	\$2134.35	\$2217.79	\$2417.25	\$2543.27	\$2623.47
		30"(762mm)	E2SP-3062-■ ■ FF	2181.57	2292.51	2388.15	2613.47	2757.41	2848.41
		36"(914mm)	E2SP-362-■ ■ FF	2536.54	2658.20	2766.04	3017.22	3179.08	3280.88
		42"(1067mm)	E2SP-4262-■ ■ FF	2541.02	2673.40	2793.44	3070.48	3250.26	3362.86
		48"(1219mm)	E2SP-462-■ ■ FF	2702.81	2845.91	2978.15	3281.05	3478.75	3602.15
		60"(1524mm)	E2SP-562-■ ■ FF	3026.39	3190.93	3347.57	3702.19	3935.73	4080.73
72"(1829mm)	24"(610mm)	E2SP-270-■ ■ FF	\$2133.68	\$2243.82	\$2330.98	\$2543.96	\$2676.28	\$2761.40	
	30"(762mm)	E2SP-3070-■ ■ FF	2325.96	2446.82	2546.18	2785.02	2935.26	3031.18	
	36"(914mm)	E2SP-370-■ ■ FF	2496.72	2628.30	2739.86	3004.56	3172.72	3279.44	
	42"(1067mm)	E2SP-4270-■ ■ FF	2667.48	2809.78	2933.54	3224.10	3410.18	3527.70	
	48"(1219mm)	E2SP-470-■ ■ FF	2838.24	2991.26	3127.22	3443.64	3647.64	3775.96	
	60"(1524mm)	E2SP-570-■ ■ FF	3179.76	3354.22	3514.58	3882.72	4122.56	4272.48	
80"(2032mm)	24"(610mm)	E2SP-278-■ ■ FF	\$2394.67	\$2514.73	\$2605.61	\$2832.11	\$2970.73	\$3060.77	
	30"(762mm)	E2SP-3078-■ ■ FF	2640.76	2771.54	2874.62	3126.98	3283.52	3384.36	
	36"(914mm)	E2SP-378-■ ■ FF	2865.33	3006.83	3122.11	3400.33	3574.79	3686.43	
	42"(1067mm)	E2SP-4278-■ ■ FF	3089.90	3242.12	3369.60	3673.68	3866.06	3988.50	
	48"(1219mm)	E2SP-478-■ ■ FF	3314.47	3477.41	3617.09	3947.03	4157.33	4290.57	
	60"(1524mm)	E2SP-578-■ ■ FF	3763.61	3947.99	4112.07	4493.73	4739.87	4894.71	

Monolithic Panel Core without Insert(s) — No Power

UniGroup Too

Panel Core

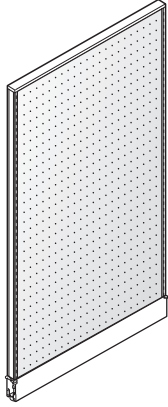

E2BN-B (Non-Powered)

Features

- Includes non-powered panel core assembly, square top cap with aligner, with or without one-piece base raceway cover, 1.6 hinge kits, side trim rails, leveling glides and carpet gripper. .6" top cap end plugs and base raceway end caps are shipped with each panel. Order additional as necessary.
- **For use with separately specified inserts.**
- Panel thickness is 2" (51mm).
- Base raceway is 4" (102mm) high.
- Shipped with unassembled top cap, base raceway cover and side trim rails.

Specification Tips

- Panels will accept add-on panels up to a combined height of 80" (2032mm). For aesthetic consistency, specify UniGroup Too add-on panels.
- Raceway cover must be separately specified for option -BE (no raceway cover).
- If 90° top cap for four-way and 120° top cap for three-way are not specified, additional top cap end plugs will need to be ordered.
- Additional top cap end plugs and base raceway end caps will need to be specified if finish posts are not ordered.

To Order, Specify:

- 1) Product number, including:

① Options:

B With Raceway Cover

BE Without Raceway Cover, deduct **\$98.65** list

- 2) Trim color raceway cover, glide housings and end caps.
- 3) Trim color for top cap and side trim rails.

Note: Upcharge for mixed surface grades, refer to the electronic design and specification tools for pricing.

NOTES:

- *Non-powered panels ship without receptacle ports in the base raceway cover.*
- *Some building codes may restrict the use of panel heights greater than 69" (1753mm). Consult your local code authority to assure that the furniture layout is compliant.*
- *For International Power, specify non-powered panels and use Power Logic components. See Specification Guide for more information on Power Logic.*
- *For Chicago power, specify non-powered panels without a base raceway cover and separately specify Chicago power retrofit kit.*

Monolithic Panel Core without Insert(s) — No Power

UniGroup Too

Panel Core	Actual Height	Width	Number ^①	Trim	
				A	B
32"(813mm)	24"(610mm)	30"(762mm)	E2BN-230- [] []	\$ 614.67	\$ 635.43
			E2BN-3030- [] []	668.48	689.59
			E2BN-330- [] []	722.29	743.75
			E2BN-4230- [] []	776.10	797.91
			E2BN-430- [] []	829.91	852.07
			E2BN-530- [] []	937.53	960.39
40"(1016mm)	24"(610mm)	30"(762mm)	E2BN-238- [] []	\$ 646.94	\$ 668.60
			E2BN-3038- [] []	722.27	744.28
			E2BN-338- [] []	776.08	798.44
			E2BN-4238- [] []	829.89	852.60
			E2BN-438- [] []	883.70	906.76
			E2BN-538- [] []	991.32	1015.08
48"(1219mm)	24"(610mm)	30"(762mm)	E2BN-246- [] []	\$ 679.21	\$ 701.77
			E2BN-3046- [] []	754.54	777.45
			E2BN-346- [] []	808.35	831.61
			E2BN-4246- [] []	862.16	885.77
			E2BN-446- [] []	915.97	939.93
			E2BN-546- [] []	1023.59	1048.25
56"(1422mm)	24"(610mm)	30"(762mm)	E2BN-254- [] []	\$ 711.48	\$ 734.94
			E2BN-3054- [] []	786.81	810.62
			E2BN-354- [] []	840.62	864.78
			E2BN-4254- [] []	894.43	918.94
			E2BN-454- [] []	948.24	973.10
			E2BN-554- [] []	1055.86	1081.42
64"(1626mm)	24"(610mm)	30"(762mm)	E2BN-262- [] []	\$ 743.75	\$ 768.11
			E2BN-3062- [] []	819.08	843.79
			E2BN-362- [] []	872.89	897.95
			E2BN-4262- [] []	926.70	952.11
			E2BN-462- [] []	980.51	1006.27
			E2BN-562- [] []	1088.13	1114.59
72"(1829mm)	24"(610mm)	30"(762mm)	E2BN-270- [] []	\$ 776.02	\$ 801.28
			E2BN-3070- [] []	851.35	876.96
			E2BN-370- [] []	905.16	931.12
			E2BN-4270- [] []	958.97	985.28
			E2BN-470- [] []	1012.78	1039.44
			E2BN-570- [] []	1120.40	1147.76
80"(2032mm)	24"(610mm)	30"(762mm)	E2BN-278- [] []	\$ 969.73	\$ 995.89
			E2BN-3078- [] []	1073.76	1100.27
			E2BN-378- [] []	1156.27	1183.13
			E2BN-4278- [] []	1238.78	1265.99
			E2BN-478- [] []	1321.29	1348.85
			E2BN-578- [] []	1486.31	1514.57

Monolithic Panel Core without Insert(s) — Powered

UniGroup Too

Panel Core



E2BP-B (3-circuit)
E2BP-2 (4-circuit, 2+2)
E2BP-4 (4-circuit, 3+1)



Features

- Includes powered panel core assembly, square top cap with aligner, with or without one-piece base raceway cover, 1.6 hinge kits, side trim rails, leveling glides and carpet gripper; power distribution assembly/flex connector(s). .6 top cap end plugs and base raceway end caps are shipped with each panel. Order additional as necessary.
- **For use with separately specified inserts.**
- Panel thickness is 2"(51mm).
- Base raceway is 4"(102mm) high.
- Powered raceway with or without raceway cover requires modified catalog number and list price.
- Powered panels are available for countries that utilize 120 volt 60 hertz electrical systems and U.S. configured plugs and outlets.
- Shipped with unassembled top cap, base raceway cover and side trim rails.

Specification Tips

- Panels will accept add-on panels up to a combined height of 80"(2032mm). For aesthetic consistency, specify UniGroup Too add-on panels.
- Flex connectors provided for powered monolithic panels accommodate straight in-line, inside 90°, and inside 120° conditions (if applicable).
- Receptacles for powered panels must be specified separately.
- Raceway cover must be separately specified for option -BE, -BYE, -2E, -2YE, -4E or -4YE (no raceway cover).
- If 90° top cap for four-way and 120° top cap for three-way are not specified, additional top cap end plugs will need to be ordered.
- Additional top cap end plugs and base raceway end caps will need to be specified if finish posts are not ordered.

To Order, Specify:

1) Product number, including:

① 3-Circuit

- B** With Raceway Cover
- BE** Without Raceway Cover, deduct **\$127.34** list
- BY** NYC with Raceway Cover
- BYE** NYC without Raceway Cover, deduct **\$127.34** list

4-Circuit, 2+2

- 2** With Raceway Cover
- 2E** Without Raceway Cover, deduct **\$127.34** list
- 2Y** NYC with Raceway Cover
- 2YE** NYC without Raceway Cover, deduct **\$127.34** list

4-Circuit, 3+1

- 4** With Raceway Cover
- 4E** Without Raceway Cover, deduct **\$127.34** list
- 4Y** NYC with Raceway Cover
- 4YE** NYC without Raceway Cover, deduct **\$127.34** list

2) Trim color raceway cover, glide housings and end caps.

3) Trim color for top cap and side trim rails.

Note: Upcharge for mixed surface grades, refer to the electronic design and specification tools for pricing.

NOTES:

- Powered panels with raceway covers ship with receptacle ports in the base raceway cover. Receptacle ports on the raceway cover measure 2.35"(60mm) top-to-bottom and 2.88"(73mm) side-to-side.
- Powered panels with Power Distribution Assemblies (PDA) but without raceway covers require separately specified base raceway covers for power and communication port locations other than the standard powered base raceway cover.
- New York City (NYC) electrical applications require field installation of PDA.
- New York Port Authority (NYPA) electrical applications require metal raceway covers. To order, specify NYC powered panels without raceway cover and separately specify metal covers through Haworth e-Parts.
- Some building codes may restrict the use of panel heights greater than 69"(1753mm). Consult your local code authority to assure that the furniture layout is compliant.
- For International Power, specify non-powered panels and use Power Logic components. See Specification Guide for more information on Power Logic.
- For Chicago power, specify non-powered panels without a base raceway cover and separately specify Chicago power retrofit kit.

Monolithic Panel Core without Insert(s) — Powered

UniGroup Too

Panel Core	Actual Height	Width	Number ^①	Trim	
				A	B
32"(813mm)	24"(610mm)	E2BP-230-		\$1050.15	\$1070.91
		E2BP-3030-		1103.96	1125.07
		E2BP-330-		1157.77	1179.23
		E2BP-4230-		1211.58	1233.39
		E2BP-430-		1265.39	1287.55
		E2BP-530-		1373.01	1395.87
40"(1016mm)	24"(610mm)	E2BP-238-		\$1082.42	\$1104.08
		E2BP-3038-		1157.75	1179.76
		E2BP-338-		1211.56	1233.92
		E2BP-4238-		1265.37	1288.08
		E2BP-438-		1319.18	1342.24
		E2BP-538-		1426.80	1450.56
48"(1219mm)	24"(610mm)	E2BP-246-		\$1114.69	\$1137.25
		E2BP-3046-		1190.02	1212.93
		E2BP-346-		1243.83	1267.09
		E2BP-4246-		1297.64	1321.25
		E2BP-446-		1351.45	1375.41
		E2BP-546-		1459.07	1483.73
56"(1422mm)	24"(610mm)	E2BP-254-		\$1146.96	\$1170.42
		E2BP-3054-		1222.29	1246.10
		E2BP-354-		1276.10	1300.26
		E2BP-4254-		1329.91	1354.42
		E2BP-454-		1383.72	1408.58
		E2BP-554-		1491.34	1516.90
64"(1626mm)	24"(610mm)	E2BP-262-		\$1179.23	\$1203.59
		E2BP-3062-		1254.56	1279.27
		E2BP-362-		1308.37	1333.43
		E2BP-4262-		1362.18	1387.59
		E2BP-462-		1415.99	1441.75
		E2BP-562-		1523.61	1550.07
72"(1829mm)	24"(610mm)	E2BP-270-		\$1211.50	\$1236.76
		E2BP-3070-		1286.83	1312.44
		E2BP-370-		1340.64	1366.60
		E2BP-4270-		1394.45	1420.76
		E2BP-470-		1448.26	1474.92
		E2BP-570-		1555.88	1583.24
80"(2032mm)	24"(610mm)	E2BP-278-		\$1405.21	\$1431.37
		E2BP-3078-		1509.24	1535.75
		E2BP-378-		1591.75	1618.61
		E2BP-4278-		1674.26	1701.47
		E2BP-478-		1756.77	1784.33
		E2BP-578-		1921.79	1950.05

Glazed Monolithic Panel — No Power

UniGroup Too

Glazed

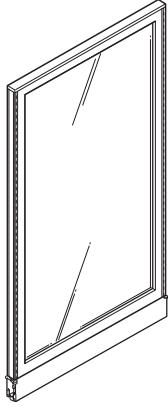

E2GN-B (Non-Powered)

Features

- Includes non-powered panel assembly, square top cap with aligner, with or without one-piece base raceway cover, 1.6 hinge kits, side trim rails, leveling glides and carpet gripper. .6 top cap end plugs and base raceway end caps are shipped with each panel. Order additional as necessary.
- Includes 0.25" (6mm) thick clear tempered safety glass or frosted acrylic.
- Panel thickness is 2" (51mm).
- Base raceway is 4" (102mm) high.
- Does not accept top feed modules.
- Shipped with unassembled top cap, base raceway cover and side trim rails.

Specification Tips

- Panels will accept glazed add-on panels up to a combined height of 80" (2032mm). For aesthetic consistency, specify UniGroup Too add-on panels.
- Raceway cover must be separately specified for option -BE (no raceway cover).
- If 90° top cap for four-way and 120° top cap for three-way are not specified, additional top cap end plugs will need to be ordered.
- Additional top cap end plugs and base raceway end caps will need to be specified if finish posts are not ordered.

To Order, Specify:

- 1) Product number, including:

① Options:

- B** With Raceway Cover
- BE** Without Raceway Cover, deduct **\$72.25** list

- 2) Glazing finish color.
- 3) Trim color raceway cover.
- 4) Trim color for frame, top cap and side trim rails.

Note: Upcharge for mixed surface grades, refer to the electronic design and specification tools for pricing.

NOTES:

- Non-powered panels ship without receptacle ports in the base raceway cover.
- Some building codes may restrict the use of panel heights greater than 69" (1753mm). Consult your local code authority to assure that the furniture layout is compliant.
- For International Power, specify non-powered panels and use Power Logic components. See Specification Guide for more information on Power Logic.
- For Chicago power, specify non-powered panels without a base raceway cover and separately specify Chicago power retrofit kit.

Glazed Monolithic Panel — No Power

UniGroup Too

	Actual Height	Width	Number ①	Clear Trim A	Trim B	Frosted Trim A	Trim B
Glazed	64"(1626mm)	24"(610mm)	E2GN-262-■ ■	\$2083.77	\$2165.15	\$2464.06	\$2545.44
		30"(762mm)	E2GN-3062-■ ■	2311.77	2395.01	2692.06	2775.30
		36"(914mm)	E2GN-362-■ ■	2520.77	2605.87	3107.30	3192.40
		42"(1067mm)	E2GN-4262-■ ■	2729.77	2816.73	3316.30	3403.26
		48"(1219mm)	E2GN-462-■ ■	2957.77	3046.59	3544.30	3633.12
		60"(1524mm)	E2GN-562-■ ■	3375.77	3468.31	3962.30	4054.84
	72"(1829mm)	24"(610mm)	E2GN-270-■ ■	\$2389.80	\$2478.65	\$2770.09	\$2858.94
		30"(762mm)	E2GN-3070-■ ■	2617.80	2708.51	2998.09	3088.80
		36"(914mm)	E2GN-370-■ ■	2864.80	2957.37	3451.33	3543.90
		42"(1067mm)	E2GN-4270-■ ■	3111.80	3206.23	3698.33	3792.76
		48"(1219mm)	E2GN-470-■ ■	3339.80	3436.09	3926.33	4022.62
		60"(1524mm)	E2GN-570-■ ■	3833.80	3933.81	4420.33	4520.34
	80"(2032mm)	24"(610mm)	E2GN-278-■ ■	\$2676.83	\$2780.62	\$3057.12	\$3160.91
		30"(762mm)	E2GN-3078-■ ■	2942.83	3048.48	3323.12	3428.77
		36"(914mm)	E2GN-378-■ ■	3208.83	3316.34	3795.36	3902.87
		42"(1067mm)	E2GN-4278-■ ■	3474.83	3584.20	4061.36	4170.73
		48"(1219mm)	E2GN-478-■ ■	3740.83	3852.06	4327.36	4438.59
		60"(1524mm)	E2GN-578-■ ■	4272.83	4387.78	4859.36	4974.31

Glazed Monolithic Panel — Powered

UniGroup Too

Glazed

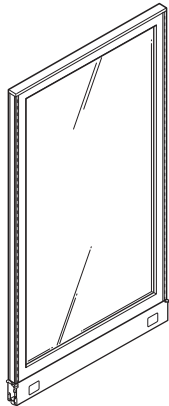

E2GP-B (3-circuit)
E2GP-2 (4-circuit, 2+2)
E2GP-4 (4-circuit, 3+1)



Features

- Includes powered panel assembly, square top cap with aligner, with or without one-piece base raceway cover, 1.6 hinge kits, side trim rails, leveling glides and carpet gripper; power distribution assembly/flex connector(s). .6 top cap end plugs and base raceway end caps are shipped with each panel. Order additional as necessary.
- Includes 0.25" (6mm) thick clear tempered safety glass or frosted acrylic.
- Panel thickness is 2" (51mm).
- Base raceway is 4" (102mm) high.
- Powered raceway with or without raceway cover requires modified catalog number and list price.
- Powered panels are available for countries that utilize 120 volt 60 hertz electrical systems and U.S. configured plugs and outlets.
- Does not accept top feed modules.
- Shipped with unassembled top cap, base raceway cover and side trim rails.

Specification Tips

- Panels will accept glazed add-on panels up to a combined height of 80" (2032mm). For aesthetic consistency, specify UniGroup Too add-on panels.
- Flex connectors provided for powered monolithic panels accommodate straight in-line, inside 90°, and inside 120° conditions (if applicable).
- Receptacles for powered panels must be specified separately.
- Raceway cover must be separately specified for option -BE, BYE, 2E, 2YE, 4E or 4YE (no raceway cover).
- If 90° top cap for four-way and 120° top cap for three-way are not specified, additional top cap end plugs will need to be ordered.
- Additional top cap end plugs and base raceway end caps will need to be specified if finish posts are not ordered.

To Order, Specify:

1) Product number, including:

① 3-Circuit

- B** With Raceway Cover
- BE** Without Raceway Cover, deduct **\$138.36** list
- BY** NYC with Raceway Cover
- BYE** NYC without Raceway Cover, deduct **\$138.36** list

4-Circuit, 2+2

- 2** With Raceway Cover
- 2E** Without Raceway Cover, deduct **\$138.36** list
- 2Y** NYC with Raceway Cover
- 2YE** NYC without Raceway Cover, deduct **\$138.36** list

4-Circuit, 3+1

- 4** With Raceway Cover
- 4E** Without Raceway Cover, deduct **\$138.36** list
- 4Y** NYC with Raceway Cover
- 4YE** NYC without Raceway Cover, deduct **\$138.36** list

2) Glazing finish color.

3) Trim color raceway cover.

4) Trim color for frame, top cap and side trim rails.

Note: Upcharge for mixed surface grades, refer to the electronic design and specification tools for pricing.

NOTES:

- Powered panels with raceway covers ship with receptacle ports in the base raceway cover. Receptacle ports on the raceway cover measure 2.35" (60mm) top-to-bottom and 2.88" (73mm) side-to-side.
- Powered panels with Power Distribution Assemblies (PDA) but without raceway covers require separately specified base raceway covers for power and communication port locations other than the standard powered base raceway cover.
- New York City (NYC) electrical applications require field installation of PDA.
- New York Port Authority (NYPA) electrical applications require metal raceway covers. To order, specify NYC powered panels without raceway cover and separately specify metal covers through Haworth e-Parts.
- Some building codes may restrict the use of panel heights greater than 69" (1753mm). Consult your local code authority to assure that the furniture layout is compliant.
- For International Power, specify non-powered panels and use Power Logic components. See Specification Guide for more information on Power Logic.
- For Chicago power, specify non-powered panels without a base raceway cover and separately specify Chicago power retrofit kit.

Glazed Monolithic Panel — Powered

UniGroup Too

	Actual Height	Width	Number ①	Clear Trim A	Trim B	Frosted Trim A	Trim B
Glazed	64"(1626mm)	24"(610mm)	E2GP-262-■ ■	\$2585.14	\$2666.52	\$2965.43	\$3046.81
		30"(762mm)	E2GP-3062-■ ■	2813.14	2896.38	3193.43	3276.67
		36"(914mm)	E2GP-362-■ ■	3022.14	3107.24	3608.67	3693.77
		42"(1067mm)	E2GP-4262-■ ■	3231.14	3318.10	3817.67	3904.63
		48"(1219mm)	E2GP-462-■ ■	3459.14	3547.96	4045.67	4134.49
		60"(1524mm)	E2GP-562-■ ■	3877.14	3969.68	4463.67	4556.21
	72"(1829mm)	24"(610mm)	E2GP-270-■ ■	\$2891.17	\$2980.02	\$3271.46	\$3360.31
		30"(762mm)	E2GP-3070-■ ■	3119.17	3209.88	3499.46	3590.17
		36"(914mm)	E2GP-370-■ ■	3366.17	3458.74	3952.70	4045.27
		42"(1067mm)	E2GP-4270-■ ■	3613.17	3707.60	4199.70	4294.13
		48"(1219mm)	E2GP-470-■ ■	3841.17	3937.46	4427.70	4523.99
		60"(1524mm)	E2GP-570-■ ■	4335.17	4435.18	4921.70	5021.71
	80"(2032mm)	24"(610mm)	E2GP-278-■ ■	\$3178.20	\$3281.99	\$3558.49	\$3662.28
		30"(762mm)	E2GP-3078-■ ■	3444.20	3549.85	3824.49	3930.14
		36"(914mm)	E2GP-378-■ ■	3710.20	3817.71	4296.73	4404.24
		42"(1067mm)	E2GP-4278-■ ■	3976.20	4085.57	4562.73	4672.10
		48"(1219mm)	E2GP-478-■ ■	4242.20	4353.43	4828.73	4939.96
		60"(1524mm)	E2GP-578-■ ■	4774.20	4889.15	5360.73	5475.68

Base Insert

UniGroup Too

Base Insert — Fabric

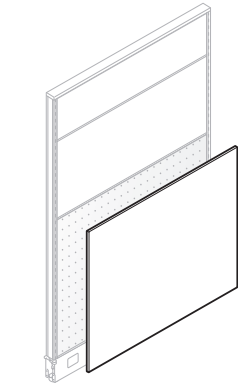
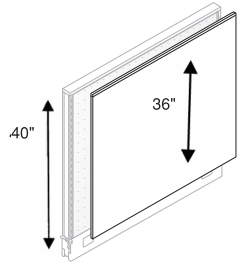

E2JF

Feature

- Includes one base insert.

Specification Tips

- Only for use at base with monolithic core panel, separately specified.
- May be used with upper inserts and appropriate height panel core.
- Base and/or upper insert combinations may vary per panel side.
- Only one base insert per side is allowed.

To Order, Specify:

- 1) Product number.
- 2) Fabric/colorway.

Installed Height	Insert Height	Width	Number	Fabric Grade					
				A	B	C	E	F	G
16"(406mm)	12"(305mm)	24"(610mm)	E2JF-214	\$ 99.60	\$115.58	\$131.66	\$ 168.36	\$ 193.28	\$ 208.58
		30"(762mm)	E2JF-3014	111.44	129.42	147.34	188.44	216.40	233.54
		36"(914mm)	E2JF-314	124.76	144.99	164.98	211.03	242.41	261.62
		42"(1067mm)	E2JF-4214	136.60	158.83	180.66	231.11	265.53	286.58
		48"(1219mm)	E2JF-414	149.92	174.40	198.30	253.70	291.54	314.66
32"(813mm)	28"(711mm)	60"(1524mm)	E2JF-514	173.60	202.08	229.66	293.86	337.78	364.58
		24"(610mm)	E2JF-230	\$155.84	\$181.32	\$206.14	\$ 263.74	\$ 303.10	\$ 327.14
		30"(762mm)	E2JF-3030	182.48	212.46	241.42	308.92	355.12	383.30
		36"(914mm)	E2JF-330	209.12	243.60	276.70	354.10	407.14	439.46
		42"(1067mm)	E2JF-4230	235.76	274.74	311.98	399.28	459.16	495.62
40"(1016mm)	36"(914mm)	48"(1219mm)	E2JF-430	262.40	305.88	347.26	444.46	511.18	551.78
		60"(1524mm)	E2JF-530	315.68	368.16	417.82	534.82	615.22	664.10
		24"(610mm)	E2JF-238	\$185.44	\$215.92	\$245.34	\$ 313.94	\$ 360.90	\$ 389.54
		30"(762mm)	E2JF-3038	218.00	253.98	288.46	369.16	424.48	458.18
		36"(914mm)	E2JF-338	252.04	293.77	333.54	426.89	490.95	529.94
48"(1219mm)	44"(1118mm)	42"(1067mm)	E2JF-4238	286.08	333.56	378.62	484.62	557.42	601.70
		48"(1219mm)	E2JF-438	320.12	373.35	423.70	542.35	623.89	673.46
		60"(1524mm)	E2JF-538	386.72	451.20	511.90	655.30	753.94	813.86
		24"(610mm)	E2JF-246	\$213.56	\$248.79	\$282.58	\$ 361.63	\$ 415.81	\$ 448.82
		30"(762mm)	E2JF-3046	253.52	295.50	335.50	429.40	493.84	533.06
56"(1422mm)	52"(1321mm)	36"(914mm)	E2JF-346	294.96	343.94	390.38	499.68	574.76	620.42
		42"(1067mm)	E2JF-4246	336.40	392.38	445.26	569.96	655.68	707.78
		48"(1219mm)	E2JF-446	376.36	439.09	498.18	637.73	733.71	792.02
		60"(1524mm)	E2JF-546	457.76	534.24	605.98	775.78	892.66	963.62
		24"(610mm)	E2JF-254	\$241.68	\$281.66	\$319.82	\$ 409.32	\$ 470.72	\$ 508.10
64"(1626mm)	60"(1524mm)	30"(762mm)	E2JF-3054	289.04	337.02	382.54	489.64	563.20	607.94
		36"(914mm)	E2JF-354	337.88	394.11	447.22	572.47	658.57	710.90
		42"(1067mm)	E2JF-4254	385.24	449.47	509.94	652.79	751.05	810.74
		48"(1219mm)	E2JF-454	434.08	506.56	574.62	735.62	846.42	913.70
		60"(1524mm)	E2JF-554	528.80	617.28	700.06	896.26	1031.38	1113.38
72"(1829mm)	68"(1727mm)	24"(610mm)	E2JF-262	\$269.80	\$314.53	\$357.06	\$ 457.01	\$ 525.63	\$ 567.38
		30"(762mm)	E2JF-3062	324.56	378.54	429.58	549.88	632.56	682.82
		36"(914mm)	E2JF-362	380.80	444.28	504.06	645.26	742.38	801.38
		42"(1067mm)	E2JF-4262	435.56	508.29	576.58	738.13	849.31	916.82
		48"(1219mm)	E2JF-462	490.32	572.30	649.10	831.00	956.24	1032.26
80"(2032mm)	76"(1930mm)	60"(1524mm)	E2JF-562	599.84	700.32	794.14	1016.74	1170.10	1263.14
		24"(610mm)	E2JF-270	\$297.92	\$347.40	\$394.30	\$ 504.70	\$ 580.54	\$ 626.66
		30"(762mm)	E2JF-3070	360.08	420.06	476.62	610.12	701.92	757.70
		36"(914mm)	E2JF-370	422.24	492.72	558.94	715.54	823.30	888.74
		42"(1067mm)	E2JF-4270	484.40	565.38	641.26	820.96	944.68	1019.78
80"(2032mm)	76"(1930mm)	48"(1219mm)	E2JF-470	546.56	638.04	723.58	926.38	1066.06	1150.82
		60"(1524mm)	E2JF-570	670.88	783.36	888.22	1137.22	1308.82	1412.90
		24"(610mm)	E2JF-278	\$327.52	\$382.00	\$433.50	\$ 554.90	\$ 638.34	\$ 689.06
		30"(762mm)	E2JF-3078	395.60	461.58	523.66	670.36	771.28	832.58
		36"(914mm)	E2JF-378	465.16	542.89	615.78	788.33	907.11	979.22
80"(2032mm)	76"(1930mm)	42"(1067mm)	E2JF-4278	534.72	624.20	707.90	906.30	1042.94	1125.86
		48"(1219mm)	E2JF-478	604.28	705.51	800.02	1024.27	1178.77	1272.50
		60"(1524mm)	E2JF-578	741.92	866.40	982.30	1257.70	1447.54	1562.66

Upper Inserts

UniGroup Too

Upper Insert — Fabric or Markerboard

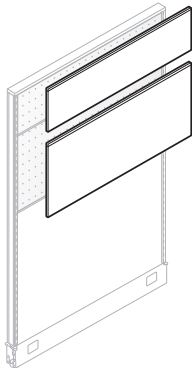

E2TF

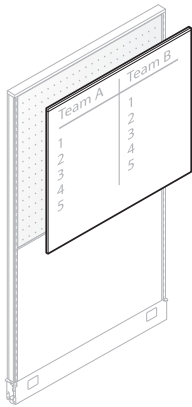

E2TM

Feature

- Includes one insert and segment trim strip or markerboard tray.

Specification Tips

- For markerboard installation allow clearance above panel equal to height of insert.
- Must be used with monolithic core panel and base insert, separately specified.
- Maximum of 4 upper inserts is allowed per panel side.
- Base and/or upper insert combinations may vary per panel side.
- Markerboard cleaner & conditioner, order service part #7031-7001.
- Order markerboard with tray in lower application to protect lower fabric insert.

(M) Product marked with this symbol available as GSA open market.

To Order, Specify:

- 1) Product number, including:

1 Markerboard Option:

N Markerboard with segment trim strip

M Markerboard with tray

- 2) Fabric/colorway (for fabric insert).

- 3) Trim color for segment trim strip or markerboard tray.

Insert Height	Width	Number	Trim A Fabric Grade		C	E	F	G
			A	B				
8"(203mm)	24"(610mm)	E2TF-208	\$115.75	\$143.53	\$152.28	\$191.08	\$219.86	\$237.23
	30"(762mm)	E2TF-3008	128.74	158.47	169.39	212.96	244.88	264.22
	36"(914mm)	E2TF-308	141.73	173.41	186.50	234.84	269.90	291.21
	42"(1067mm)	E2TF-4208	154.72	188.35	203.61	256.72	294.92	318.20
	48"(1219mm)	E2TF-408	167.71	203.29	220.72	278.60	319.94	345.19
16"(406mm)	60"(1524mm)	E2TF-508	193.69	233.17	254.94	322.36	369.98	399.17
	24"(610mm)	E2TF-216	\$158.72	\$193.04	\$208.97	\$263.46	\$302.69	\$326.60
	30"(762mm)	E2TF-3016	171.71	207.98	226.08	285.34	327.71	353.59
	36"(914mm)	E2TF-316	184.70	222.92	243.19	307.22	352.73	380.58
	42"(1067mm)	E2TF-4216	197.69	237.86	260.30	329.10	377.75	407.57
	48"(1219mm)	E2TF-416	210.68	252.80	277.41	350.98	402.77	434.56
	60"(1524mm)	E2TF-516	236.66	282.68	311.63	394.74	452.81	488.54

Insert Height	Width	Number	Trim B Fabric Grade		C	E	F	G
			A	B				
8"(203mm)	24"(610mm)	E2TF-208	\$161.37	\$189.15	\$197.90	\$236.70	\$265.48	\$282.85
	30"(762mm)	E2TF-3008	174.36	204.09	215.01	258.58	290.50	309.84
	36"(914mm)	E2TF-308	187.35	219.03	232.12	280.46	315.52	336.83
	42"(1067mm)	E2TF-4208	200.34	233.97	249.23	302.34	340.54	363.82
	48"(1219mm)	E2TF-408	213.33	248.91	266.34	324.22	365.56	390.81
16"(406mm)	60"(1524mm)	E2TF-508	239.31	278.79	300.56	367.98	415.60	444.79
	24"(610mm)	E2TF-216	\$204.34	\$238.66	\$254.59	\$309.08	\$348.31	\$372.22
	30"(762mm)	E2TF-3016	217.33	253.60	271.70	330.96	373.33	399.21
	36"(914mm)	E2TF-316	230.32	268.54	288.81	352.84	398.35	426.20
	42"(1067mm)	E2TF-4216	243.31	283.48	305.92	374.72	423.37	453.19
	48"(1219mm)	E2TF-416	256.30	298.42	323.03	396.60	448.39	480.18
	60"(1524mm)	E2TF-516	282.28	328.30	357.25	440.36	498.43	534.16

			1		Trim A		Trim B	
			N	M	N	M	N	M
16"(406mm)	24"(610mm)	E2TM-216-	(M)		\$469.64	\$502.57	\$ 513.55	\$ 546.48
	30"(762mm)	E2TM-3016-	(M)		502.03	534.96	556.92	589.85
	36"(914mm)	E2TM-316-	(M)		534.42	567.35	600.29	633.22
	42"(1067mm)	E2TM-4216-	(M)		566.81	599.74	643.66	676.59
	48"(1219mm)	E2TM-416-	(M)		599.20	632.13	687.03	719.96
32"(813mm)	60"(1524mm)	E2TM-516-	(M)		663.98	696.91	773.77	806.70
	24"(610mm)	E2TM-232-	(M)		\$713.55	\$746.48	\$ 801.34	\$ 834.27
	30"(762mm)	E2TM-3032-	(M)		745.94	778.87	844.71	877.64
	36"(914mm)	E2TM-332-	(M)		778.33	811.26	888.08	921.01
	42"(1067mm)	E2TM-4232-	(M)		810.72	843.65	931.45	964.38
	48"(1219mm)	E2TM-432-	(M)		843.11	876.04	974.82	1007.75
	60"(1524mm)	E2TM-532-	(M)		907.89	940.82	1061.56	1094.49

Fabric Add-On Panel

UniGroup Too

Fabric

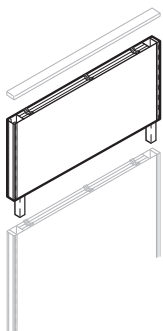

E2AM

NOTE:
This panel has fabric/
colorway restrictions,
see systems fabrics/
color legend.

Features

- Includes panel, vertical connector (bayonet), light block, side trim rails, two full hinge sets and top cap clips.
- Fabric add-on panels may be installed above straight fabric and laminate base or fabric add-on panels.
- Both sides in same fabric; one color or different color each side.
- Each base panel will accept two add-on panels.
- Lower Level add-on panel will accept overhead components (load bearing). Second add-on panel (top) is non-load bearing.
- Utilizes top cap from base panel.
- Same construction as UniGroup Too Basic Monolithic fabric panel.

Specification Tips

- Add-on panels may be stacked a maximum of two high above a UniGroup Too base panel.
- Add-on panel must match panel width.
- Combination of panel and add-on panel cannot exceed 80"(2032mm) in height.
- Cannot be used above doors or glazed panels.
- Base and add-on panel combinations should match existing base panel heights so that end-of-runs and finish posts can be used without field modification.
- Finish posts may be used, separately specified.
- Full-height side trim rails required for end-of-run conditions with a base panel and one add-on panel, separately specified.
- For two high add-on panel applications specify separately full-height side trim rail for base panel and one high add-on, for two high panel add-on location use side trim rail that ships with add-on panel. See Specification Guide for application guidelines.
- Clerestory can be added above fabric add-on panel. See Specification Guide for application guidelines.

To Order, Specify:

- 1) Product number.
- 2) Fabric/colorway for add-on panel side one.
- 3) Fabric/colorway for add-on panel side two.
- 4) Trim color for side trim rails and trim strip.

Note: For mixed grade fabric surfaces pricing will be determined by the sum of the upcharges. Please refer to the electronic catalog.

Actual Height	Width	Number	Trim A Fabric Grade					
			A	B	C	E	F	G
16"(406mm)	24"(610mm)	E2AM-216	\$ 818.65	\$ 918.23	\$1027.75	\$1266.63	\$1425.91	\$1525.51
	30"(762mm)	E2AM-3016	859.09	964.55	1081.03	1334.79	1503.91	1609.51
	36"(914mm)	E2AM-316	899.53	1010.87	1134.31	1402.95	1581.91	1693.51
	42"(1067mm)	E2AM-4216	939.97	1057.19	1187.59	1471.11	1659.91	1777.51
	48"(1219mm)	E2AM-416	987.15	1111.23	1249.75	1550.63	1750.91	1875.51
	60"(1524mm)	E2AM-516	1061.29	1196.15	1347.43	1675.59	1893.91	2029.51

Actual Height	Width	Number	Trim B Fabric Grade					
			A	B	C	E	F	G
16"(406mm)	24"(610mm)	E2AM-216	\$ 822.75	\$ 922.33	\$1031.85	\$1270.73	\$1430.01	\$1529.61
	30"(762mm)	E2AM-3016	863.19	968.65	1085.13	1338.89	1508.01	1613.61
	36"(914mm)	E2AM-316	903.63	1014.97	1138.41	1407.05	1586.01	1697.61
	42"(1067mm)	E2AM-4216	944.07	1061.29	1191.69	1475.21	1664.01	1781.61
	48"(1219mm)	E2AM-416	991.25	1115.33	1253.85	1554.73	1755.01	1879.61
	60"(1524mm)	E2AM-516	1065.39	1200.25	1351.53	1679.69	1898.01	2033.61

Glazed Add-On Panel

UniGroup Too

Glazed

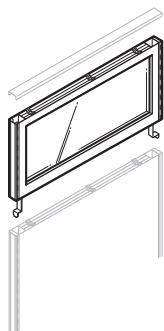

E2AG

Features

- Includes panel, vertical connector (bayonet), light block, side trim rails, two full hinge sets and top cap clips.
- Utilizes top cap from monolithic panel.
- Glazed add-on panels may be installed above glazed, fabric, laminate, fabric add-on or glazed add-on panels.
- Glazed add-on panels will not accept any load bearing components.
- Textured glazing material is textured on one side only. Recommend installing the textured side to face the interior of the workstation.

Specification Tips

- Add-on panels may be stacked a maximum of two high above a monolithic panel.
- Add-on panel width must match base panel width.
- Combination of base panel and add-on panel cannot exceed 80”(2032mm).
- Cannot be used above doors.
- Does not accept top feed modules.
- Add-on panels may be retrofitted in the field for use on glazed or fabric monolithic panels.
- To convert a glazed add-on above a fabric/laminate monolithic base panel to a glazed add-on above a glazed base panel or (vice versa), a vertical connector (bayonet) retrofit kit is available. Order separately through Haworth e-Parts.
- Finish posts may be used, separately specified.
- Full-height side trim rails required for end-of-run conditions with a base panel and one add-on panel, separately specified.
- For two high add-on panel applications specify separately full-height side trim rail for base panel and one high add-on, for two high panel add on location use side trim rail that ships with add-on panel.
- Clerestory can be added above glazed add-on panel. See Specification Guide for application guidelines.

To Order, Specify:

- 1) Product number, including:

① Application Designation:

F Glazed add-on panel **above fabric/laminate base panel or fabric add-on panel**

G Glazed add-on panel **above glazed or glazed add-on panel**, add **\$48.82** list

- 2) Glazing color or glass pattern.
- 3) Trim color for frame, side trim rails and trim strip.

Actual Height	Width	Number ①	Trim A Glass Grade		
			A	C	D
16”(406mm)	24”(610mm)	E2AG-216-	\$1162.89	\$1311.37	\$1534.08
	30”(762mm)	E2AG-3016-	1213.05	1413.25	1657.98
	36”(914mm)	E2AG-316-	1263.21	1515.13	1781.88
	42”(1067mm)	E2AG-4216-	1313.37	1617.01	1905.78
	48”(1219mm)	E2AG-416-	1363.53	1718.89	2029.68
60”(1524mm)	E2AG-516-	1463.85	1922.65	2277.48	

Actual Height	Width	Number ①	Trim B Glass Grade		
			A	C	D
16”(406mm)	24”(610mm)	E2AG-216-	\$1172.41	\$1320.89	\$1543.60
	30”(762mm)	E2AG-3016-	1224.48	1424.68	1669.41
	36”(914mm)	E2AG-316-	1276.55	1528.47	1795.22
	42”(1067mm)	E2AG-4216-	1328.62	1632.26	1921.03
	48”(1219mm)	E2AG-416-	1380.69	1736.05	2046.84
60”(1524mm)	E2AG-516-	1484.83	1943.63	2298.46	

Panel Accessories

UniGroup Too

Sliding Door

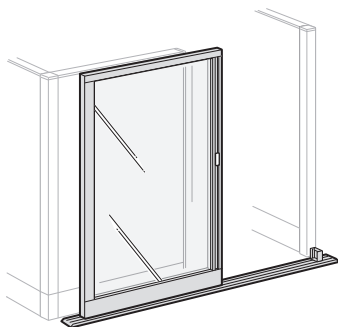

VUZF
(Left-hand door)

Features

- Includes sliding door with threshold track and optional lock.
- Available with clear glass or frosted acrylic door insert.
- Full height vertical recessed door handle.
- Sliding Door adjustable wheels allow 1.25”(32mm) height adjustment.
- Optional door lock is available; locks with key outside and lever inside. Not field retrofitable.
- Lock plugs come standard in black.
- For lock options, refer to Lock Program Price List.
- Locking mechanism locks the door into the track.
- Right-handed door slides open to right.
- Left-handed door slides open to left.

Specification Tips

- Handedness cannot be changed in the field.
- Sliding Door mounts outside of the workspace.
- Threshold track is included and must be used with the Sliding Door.
- Sliding Door can be attached to panel of same height or taller. Cannot be attached to panel lower than sliding door.
- Sliding Door Filler Post is required in certain applications and ordered separately. Refer to Specification Guide.
- Sliding Door extends 34”(864mm) for the 36”(914mm)-wide sliding door and 40”(1016mm) for the 42”(1067mm)-wide sliding door.

To Order, Specify:

1) Product number, including:

1) Insert Option:

- G Clear (SG-1C)
- X Frosted (SK-1E)

2) Handedness Option:

- R Right
- L Left

3) Locking Option:

- N Non-Locking
- L Locking, add **\$637.93** list

2) Trim color.

Nominal Height	Nominal Width	Number 1 2 3	Clear Trim A	Trim B	Frosted Trim A	Trim B
64”(1626mm)	36”(914mm)	VUZF-6436-■ ■ ■ E	\$4671.99	\$4696.11	\$5224.73	\$5248.85
	42”(1067mm)	VUZF-6442-■ ■ ■ E	4952.02	4977.86	5737.40	5763.24
72”(1829mm)	36”(914mm)	VUZF-7236-■ ■ ■ E	\$4784.31	\$4835.95	\$5420.41	\$5472.05
	42”(1067mm)	VUZF-7242-■ ■ ■ E	5064.34	5117.70	5933.08	5986.44
80”(2032mm)	36”(914mm)	VUZF-8036-■ ■ ■ E	\$4896.63	\$4975.79	\$5616.09	\$5695.25
	42”(1067mm)	VUZF-8042-■ ■ ■ E	5176.66	5257.54	6128.76	6209.64

Filler Post - Sliding Door

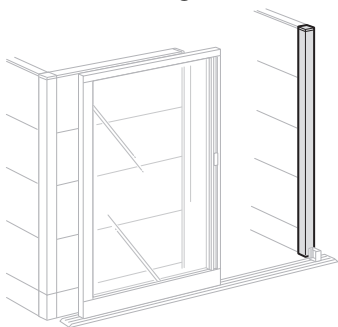

VEZP

Feature

- Includes painted filler post with square painted top cap and attachment hardware.

Specification Tips

- Filler post is required for certain Sliding Door applications. Refer to Specification Guide.
- Specify filler post to match panel height in all applications.
- Filler post is only available with UniGroup Too square profile trim.

To Order, Specify:

- 1) Product number.
- 2) Trim color for filler post.
- 3) Trim color for top cap.

Nominal Height	Number	Trim A	B
64”(1626mm)	VEZP-6400-P	\$818.32	\$855.41
72”(1829mm)	VEZP-7200-P	865.42	902.51
80”(2032mm)	VEZP-8000-P	928.22	965.31

Swing Door

UniGroup Too

Single Door — Laminate	Actual Height	Width	Number ①	Laminate A		Laminate B	
				Trim A	Trim B	Trim A	Trim B
	80"(2032mm)	36"(914mm)	E2DS-3678-B █ L	\$4472.95	\$4580.59	\$4598.51	\$4706.15
		42"(1067mm)	E2DS-4278-B █ L	4732.99	4840.63	4858.55	4966.19

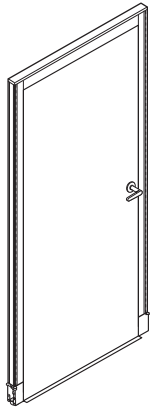

E2DS

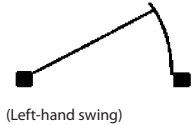

(Left-hand swing)

Features

- Includes complete panel assembly [hinge sets, carpet gripper, door jamb, side trim rails, leveling glides and trim, hollow core door (1.625"(41mm) thick), door hinges, hardware, brushed chrome knobs or ADA lever with lockset and keys, and threshold].
- Door shipped with left-hand swing and can be field-changed for right-hand swing.
- Both sides of door covered in same laminate surface color.
- No power/communications in base raceway.

Specification Tips

- Door may be placed a maximum of 24"(610mm) from supporting panels at 90°.
- Will not accept add-on panel.

Door Opening Clearance

Door Size	Height	Width
3678	78"(1981mm)	28.75"(730mm)
4278	78"(1981mm)	34.75"(883mm)

To Order, Specify:

- 1) Product number, including:

① Handle Designation:

- K** Knob
- H** ADA Lever, add **\$343.02** list

- 2) Laminate surface color.
- 3) Trim color for raceway covers and glide housings.
- 4) Trim color for door jamb, top cap and side trim rails.

NOTES:

Some building codes may restrict the use of panel heights greater than 69"(1753mm). Consult your local code authority to assure that the furniture layout is compliant prior to installation.

Most building codes for new buildings require a minimum clear door width of 32"(813mm). To meet this requirement, the 42"(1067mm) door must be ordered.

Panel Accessories

UniGroup Too

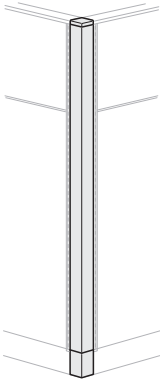
	Actual Height	Number	Trim A	B
90° Full-Height Finish Post — Square Painted Top Cap 	32"(813mm)	E2PC-30	\$134.88	\$151.40
	40"(1016mm)	E2PC-38	148.80	168.36
	48"(1219mm)	E2PC-46	162.72	185.32
	56"(1422mm)	E2PC-54	176.64	202.28
	64"(1626mm)	E2PC-62	190.56	219.24
	72"(1829mm)	E2PC-70	204.48	236.20
	80"(2032mm)	E2PC-78	218.40	253.16

E2PC

Feature

- Includes 90° vertical cover, square painted top cap and base raceway cover.

Specification Tips

- For use with equal height panels in a 90°, 2-Way condition.
- For use with UniGroup Too square painted top cap panels.
- Required by UL for covering base raceway flexible and Straight power connectors when power connector covers are not used.

To Order, Specify:

- 1) Product number.
- 2) Paint color for finish post.
- 3) Trim color for raceway cover.
- 4) Trim color for top cap.

Note: For mixed grade trim surfaces pricing will be determined by the sum of the upcharges. Please refer to the electronic catalog.

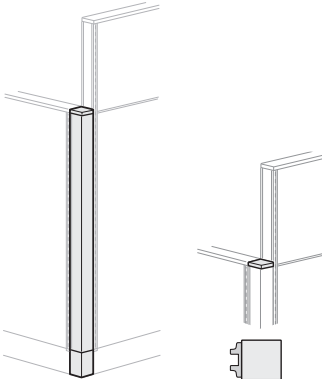
	Actual Height	Number	Trim A	B
90° Variable-Height Finish Post — Square Painted Top Cap 	32"(813mm)	E2PC-30-V	\$160.53	\$177.05
	40"(1016mm)	E2PC-38-V	174.45	194.01
	48"(1219mm)	E2PC-46-V	188.37	210.97
	56"(1422mm)	E2PC-54-V	202.29	227.93
	64"(1626mm)	E2PC-62-V	216.21	244.89
	72"(1829mm)	E2PC-70-V	230.13	261.85

E2PC-V

Feature

- Includes 90° vertical cover, square painted top cap and base raceway cover.

Specification Tips

- For use with multiple height panels in a 90°, 2-Way condition; specify height to match lowest panel height.
- For use with UniGroup Too square painted top cap panels.
- Required by UL for covering base raceway power connectors when power connector covers are not used.

To Order, Specify:

- 1) Product number.
- 2) Paint color for finish post.
- 3) Trim color for raceway cover.
- 4) Trim color for top cap.

	Height	Number	Trim A	B
90° Power Connector Cover — Square Profile 	4"(102mm)	E2PC-90-B	\$105.54	\$132.39

E2PC-90-B

Features

- Includes six covers.
- For use with UniGroup Too square painted top cap panels.
- Required by UL for covering power connector 90° panel condition when finish post is not used.

To Order, Specify:

- 1) Product number.
- 2) Trim color.

Panel Accessories

UniGroup Too

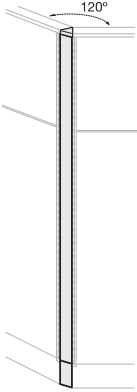
	Actual Height	Number	Trim A	B
120° Full-Height Finish Post — Square Painted Top Cap 	32"(813mm)	E2PA-30	\$150.92	\$163.91
	40"(1016mm)	E2PA-38	162.20	178.31
	48"(1219mm)	E2PA-46	173.48	192.71
	56"(1422mm)	E2PA-54	184.76	207.11
	64"(1626mm)	E2PA-62	196.04	221.51
	72"(1829mm)	E2PA-70	207.32	235.91
	80"(2032mm)	E2PA-78	218.60	250.31
Feature <ul style="list-style-type: none"> Includes 120° vertical cover, square painted top cap and base raceway cover. 		To Order, Specify: <ol style="list-style-type: none"> Product number. Paint color for finish post. Trim color for raceway cover. Trim color for top cap. 		
Specification Tips <ul style="list-style-type: none"> For use with equal height panels in a 120°, 2-Way condition. For use with UniGroup Too square top cap panels. Required by UL for covering base raceway power connectors when power connector covers are not used. 		Note: For mixed grade trim surfaces pricing will be determined by the sum of the upcharges. Please refer to the electronic catalog.		

E2PA

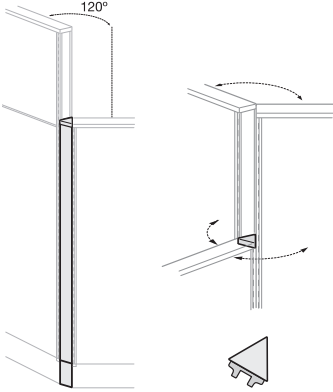
	Actual Height	Number	Trim A	B
120° Variable-Height Finish Post — Square Painted Top Cap 	32"(813mm)	E2PA-30-V	\$176.37	\$189.36
	40"(1016mm)	E2PA-38-V	187.65	203.76
	48"(1219mm)	E2PA-46-V	198.93	218.16
	56"(1422mm)	E2PA-54-V	210.21	232.56
	64"(1626mm)	E2PA-62-V	221.49	246.96
	72"(1829mm)	E2PA-70-V	232.77	261.36
Feature <ul style="list-style-type: none"> Includes 120° vertical cover, square painted top cap and base raceway cover. 		To Order, Specify: <ol style="list-style-type: none"> Product number. Paint color for finish post. Trim color for raceway cover. Trim color for top cap. 		
Specification Tips <ul style="list-style-type: none"> For use with multiple height panels in a 120°, 2-Way condition; specify height to match lowest panel height. For use with UniGroup Too square painted top cap panels. Required by UL for covering base raceway power connectors when power connector covers are not used. 		Note: For mixed grade trim surfaces pricing will be determined by the sum of the upcharges. Please refer to the electronic catalog.		

E2PA-V

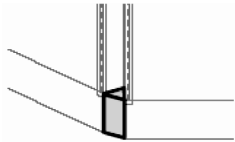
	Height	Number	Trim A	B
120° Power Connector Cover 	4"(102mm)	E2PC-120-B	\$105.54	\$132.39
	Features <ul style="list-style-type: none"> Includes six covers. For use with UniGroup Too square painted top cap panels. Required by UL for covering power connector 120° panel condition when finish post is not used. 		To Order, Specify: <ol style="list-style-type: none"> Product number. Trim color. 	
Specification Tip <ul style="list-style-type: none"> Can also be used with UniGroup and PLACES. 				

E2PC-120-B

Panel Accessories

UniGroup Too

	Actual Height	Number	Trim A	B
180° Full-Height Finish Post — Square Painted Top Cap	32"(813mm)	E2PS-30	\$108.27	\$124.87
	40"(1016mm)	E2PS-38	121.07	140.87
	48"(1219mm)	E2PS-46	133.87	156.87
	56"(1422mm)	E2PS-54	146.67	172.87
	64"(1626mm)	E2PS-62	159.47	188.87
	72"(1829mm)	E2PS-70	172.27	204.87
	80"(2032mm)	E2PS-78	185.07	220.87



E2FS
E2PS

Feature

- Includes 180° vertical cover, square painted top cap and base raceway cover.

Specification Tips

- For use with equal height panels in a 180°, 3-Way condition.
- For use with panels with UniGroup Too square painted top cap.
- Required by UL for covering base raceway power connectors when power connector covers are not used.

To Order, Specify:

- Product number.
- Paint color for finish post.
- Trim color for raceway cover.
- Trim color for top cap.

Note: For mixed grade trim surfaces pricing will be determined by the sum of the upcharges. Please refer to the electronic catalog.

	Actual Height	Number	Trim A	B
180° Variable-Height Finish Post — Square Painted Top Cap	32"(813mm)	E2PS-30-V1	\$133.72	\$150.32
		E2PS-30-V2I	133.72	150.32
		E2PS-30-V2L	133.72	150.32
	40"(1016mm)	E2PS-38-V1	\$146.52	\$166.32
		E2PS-38-V2I	146.52	166.32
		E2PS-38-V2L	146.52	166.32
	48"(1219mm)	E2PS-46-V1	\$159.32	\$182.32
		E2PS-46-V2I	159.32	182.32
		E2PS-46-V2L	159.32	182.32
	56"(1422mm)	E2PS-54-V1	\$172.12	\$198.32
		E2PS-54-V2I	172.12	198.32
		E2PS-54-V2L	172.12	198.32
	64"(1626mm)	E2PS-62-V1	\$184.92	\$214.32
		E2PS-62-V2I	184.92	214.32
		E2PS-62-V2L	184.92	214.32
	72"(1829mm)	E2PS-70-V1	\$197.72	\$230.32
		E2PS-70-V2I	197.72	230.32
		E2PS-70-V2L	197.72	230.32
	80"(2032mm)	E2PS-78-V2I	\$210.52	\$246.32

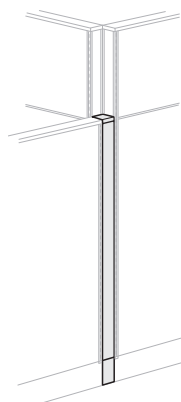

E2FS-V
E2PS-V

Features

- Includes 180° vertical cover, square painted top cap and base raceway cover.
- Includes top cap with one or two alignment tabs; specify accordingly.

Specification Tips

- For use with multiple height panels in a 180°, 3-Way condition; specify height to match lowest panel height.
- Product specification must reflect number of top cap alignment tabs for lowest like panel heights in an "I" or "L" condition; see Product Application Guidelines for details.
- Top cap alignment tabs are for dedicated applications and are not field removable; -V1, -V2I, -V2L.
- For use with panels with UniGroup Too square painted top cap.
- Required by UL for covering base raceway power connectors when power connector covers are not used.

To Order, Specify:

- Product number.
- Paint color for finish post.
- Trim color for raceway cover.
- Trim color for top cap.

Note: For mixed grade trim surfaces pricing will be determined by the sum of the upcharges. Please refer to the electronic catalog.

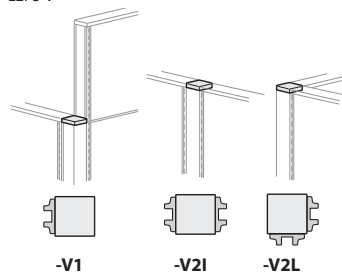

Panel Accessories

UniGroup Too

	Height	Number	Price
180° Power Connector Cover	4"(102mm)	PCC-180-B	\$118.35

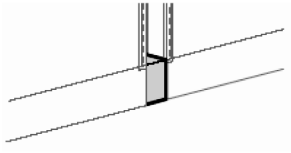

PPC-180-B
Class AA

Features

- Includes six covers.
- For use with UniGroup Too square painted top cap panels.
- Required by UL for covering power connector 180° panel condition when finish post is not used.

To Order, Specify:

- 1) Product number.
- 2) Trim color.

Specification Tip

- Can also be used with UniGroup and PLACES.

180° Vertical Cover only, (no top cap or base raceway cover)	Actual Height	Number	Trim A	B
	8"(203mm)	E2PS-08-N	\$ 42.48	\$ 68.36
16"(406mm)	E2PS-16-N	55.60	81.48	
24"(610mm)	E2PS-24-N	68.72	94.60	
32"(813mm)	E2PS-32-N	81.84	107.72	
40"(1016mm)	E2PS-40-N	94.96	120.84	
48"(1219mm)	E2PS-48-N	108.08	133.96	

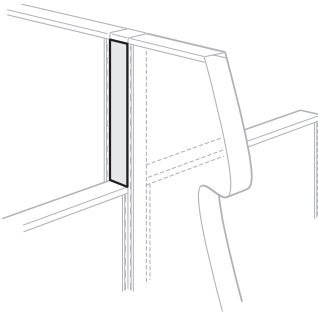

E2PS-N
E2FS-N
Class AC

Feature

- Includes 180° vertical cover only.

Specification Tips

- For use with separately specified 180° finish post or 90° top cap.
- See Specification Guide for details.

To Order, Specify:

- 1) Product number:
- 2) Paint color for finish post.

Panel Accessories

UniGroup Too

	Number	Trim A	B
90° Square Painted Top Cap for 2-Way, 3-Way, 4-Way	E2CC-90-1	\$80.61	\$109.40
	E2CC-90-2I	80.61	109.40
	E2CC-90-2L	80.61	109.40
	E2CC-90-3	80.61	109.40
	E2CC-90-4	80.61	109.40

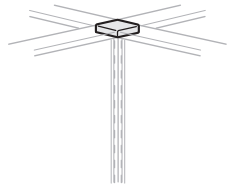

E2CC-90

Features

- Includes square painted top cap for 90° or 180° panel intersection.
- Includes one, two, three, or four alignment tabs; specify accordingly.

To Order, Specify:

- 1) Product number.
- 2) Trim color.

Specification Tips

- Typically used with separately specified 180° Vertical Cover unless used in a 4-way condition with equal height panels.
- Product specification must reflect number of top cap alignment tabs for like panel heights in an "I", "L", "T", or "X" condition.
- See Product Specification Guide for details.
- Top cap alignment tabs are for dedicated applications and are not field removable.

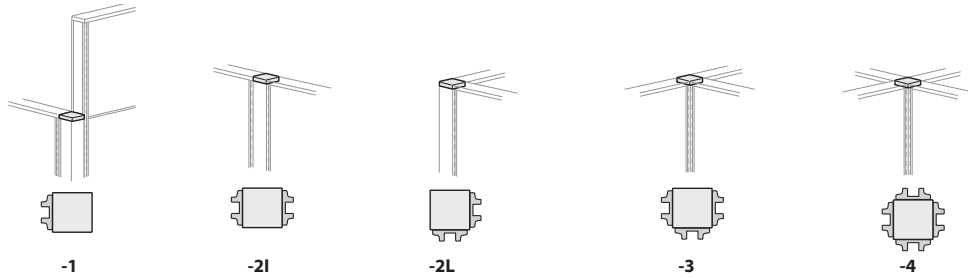

120° Square Painted Top Cap for 2-Way or 3-Way

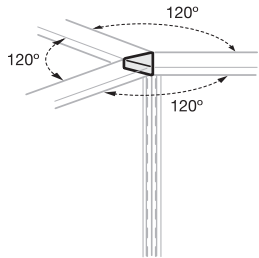

E2CA-120

	E2CA-120-1	\$102.38	\$132.74
	E2CA-120-2	102.38	132.74
	E2CA-120-3	102.38	132.74

Features

- Includes square painted top cap for 120° panel intersection.
- Includes one, two or three alignment tabs; specify accordingly.

To Order, Specify:

- 1) Product number.
- 2) Trim color.

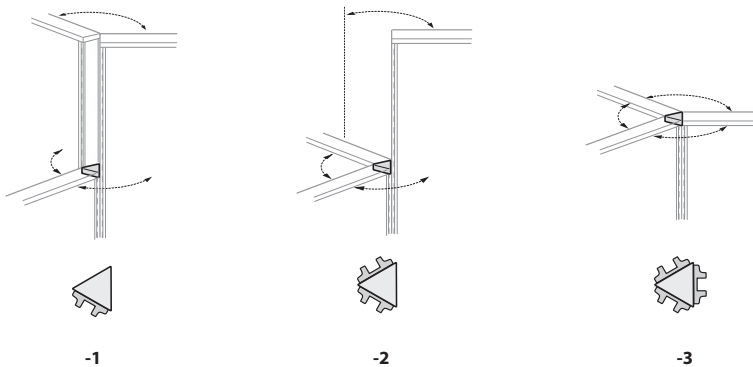

Specification Tips

- Product specification must reflect number of top cap alignment tabs for like panel heights in 120° 2-Way or 3-Way condition.
- For use in 120° 3-Way condition with equal height panels; specify (-3) option.
- For use in 120° 3-way condition with one high and two equal height lower panels; specify (-2) option.
- See Product Specification Guide for details.
- Top cap alignment tabs are for dedicated applications and are not field removable.
- Not for use with the 180° Vertical Cover.

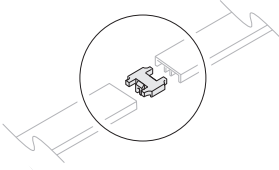
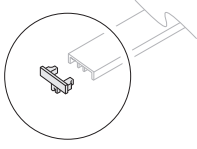

Panel Accessories

UniGroup Too

	Number	Trim A	B
UniGroup Too Top Cap Aligner  E2AL-1 Class AC	E2AL-1	\$44.13	\$70.98
Features <ul style="list-style-type: none"> Includes one top cap aligner. For use with UniGroup Too square painted top cap in an in-line panel condition. Top cap alignment tabs are for dedicated applications and not field removable. Note: One top cap aligner is included with each panel.	To Order, Specify: <ol style="list-style-type: none"> Product number. Trim color. 		
UniGroup Too Top Cap End Plug  E2EC-1 Class AC	E2EC-1	\$33.30	\$46.99
Features <ul style="list-style-type: none"> Includes one top cap end plug. For use with UniGroup Too square top cap panels. Additional top cap end plugs may be needed if finish posts are not specified. Note: .6 top cap end plugs are included with each panel. Order additional as necessary.	To Order, Specify: <ol style="list-style-type: none"> Product number. Trim color. 		
Base Raceway End Cap  EC-10-B Class AA	4"(102mm) EC-10-B	\$64.14	\$72.97
Features <ul style="list-style-type: none"> Includes ten end caps. For use at base raceway for end-of-run panel condition. Note: .6 end caps included with every panel. Order additional as necessary.	To Order, Specify: <ol style="list-style-type: none"> Product number. Trim color. 		

Panel Accessories

UniGroup Too

	Height	Base Panel Height/ Add-On Panel	Number	Trim A	B
Full Height Side Trim Rail — for use with Add-On Panels	48"(1219mm)	32"(813mm)/16"(406mm)	SREH-3016	\$158.93	\$201.43
	56"(1422mm)	40"(1016mm)/16"(406mm)	SREH-3816	167.33	225.27
	64"(1626mm)	48"(1219mm)/16"(406mm)	SREH-4616	175.73	249.11
	72"(1829mm)	56"(1422mm)/16"(406mm)	SREH-5416	184.13	272.95
	80"(2032mm)	64"(1626mm)/16"(406mm)	SREH-6216	192.53	296.79

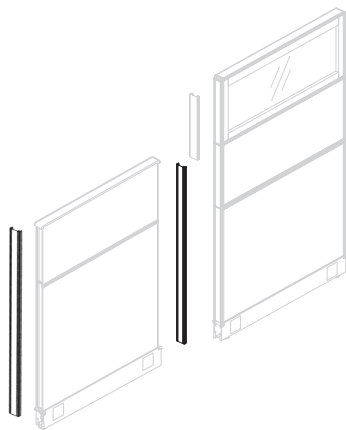

SREH

Feature

- Includes one full height side trim rail.

Specification Tips

- For use with base panel and one add-on panel.
- For two high add-on panel applications specify separately full-height side trim rail for base panel and one high add-on, for two high panel location use side trim rail that ships with add-on panel. See Specification Guide for application guidelines.

To Order, Specify:

- Product number.
- Trim color.

Side Trim Rail



SRE

Panel Height	Number	Trim A	B
32"(813mm)	SRE-30	\$119.04	\$130.66
40"(1016mm)	SRE-38	127.44	154.50
48"(1219mm)	SRE-46	135.84	178.34
56"(1422mm)	SRE-54	144.24	202.18
64"(1626mm)	SRE-62	152.64	226.02
72"(1829mm)	SRE-70	161.04	249.86
80"(2032mm)	SRE-78	169.44	273.70

Feature

- Includes one side trim rail.

Specification Tips

- Specify two side trim rails for each condition.
- Two side trim rails are included with each panel. Order as replacement only.
- For use with UniGroup Too panels only.

To Order, Specify:

- Product number.
- Trim color.

Panel Accessories

UniGroup Too

	Panel Height	Number	Price
Hinges	32"(813mm)	HE-30	\$20.99
	40"(1016mm)	HE-38	21.48
	48"(1219mm)	HE-46	21.97
	56"(1422mm)	HE-54	22.95
	64"(1626mm)	HE-62	23.44
	72"(1829mm)	HE-70	23.93
	80"(2032mm)	HE-78	24.91

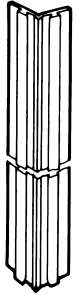

HE

Features

- Includes one hinge set for one side of trim rail.
- One hinge set connects every two panels for angular connections.
- Two hinge sets are used for straight-line conditions.
- For replacement only. Hinges are included with panels.

To Order, Specify:

- 1) Product number.
- 2) Trim color.

Specification Tip

- For use with UniGroup Too panels only.

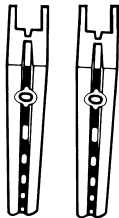
Wall Track	Height	Depth	Width	Number	Trim A	B
	60"(1524mm)	0.75"(19mm)	0.625"(16mm)	WT-60	\$233.74	\$245.38
	72"(1829mm)			WT-72	274.42	286.06
	84"(2134mm)			WT-84	315.10	326.74

WT

Features

- Includes two wall tracks and attachment screws (#10 2.5"(51mm) long).
- For attachment of components to structural walls.
- See installation instructions for proper mounting.

To Order, Specify:

- 1) Product number.
- 2) Trim color for track.

Specification Tip

- Not for use with up-mount overhead storage unit.

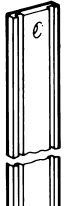
Wall Mount Kit	Height	Number	Trim A	B
	32"(813mm)	WMK-32	\$118.81	\$122.72
	40"(1016mm)	WMK-38	146.18	150.09
	48"(1219mm)	WMK-46	177.46	181.37
	56"(1422mm)	WMK-54	204.83	208.74
	64"(1626mm)	WMK-62	236.11	240.02
	72"(1829mm)	WMK-70	267.39	271.30
	80"(2032mm)	WMK-78	302.58	306.49

WMK

Features

- Includes wall-mount channel, hinges and screws.
- For mounting panels, with or without add-on panel, to a structural wall.
- Adds 0.25"(6mm) to the panel width.

To Order, Specify:

- 1) Product number.
- 2) Trim color.

Specification Tip

- Must be properly anchored to a structural wall.

Panel Accessories

UniGroup Too

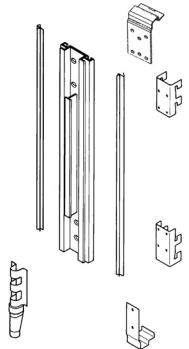
	Height	Number	Trim A	B
	32"(813mm)	E2TK-30	\$157.07	\$159.01
	40"(1016mm)	E2TK-38	174.91	178.37
	48"(1219mm)	E2TK-46	192.75	197.73
	56"(1422mm)	E2TK-54	210.59	217.09
	64"(1626mm)	E2TK-62	228.43	236.45
	72"(1829mm)	E2TK-70	246.27	255.81
	80"(2032mm)	E2TK-78	264.11	275.17

E2TK
Class AC

Features

- Includes pre-drilled side rail, center-mount brackets, end-mount brackets, light block extrusions, glide housing, and screws.
- Brackets included for both center- and end-mount T-conditions.
- Connects two panels in a T-condition. T-mount can attach to a base panel and one fabric add-on panel. Configuration coming off of a T-mount cannot contain add-on panels.

To Order, Specify:

- 1) Product number.
- 2) Trim color.

Specification Tips

- Both panels in a T-mount condition must be of equal height.
- Cannot mount on glazed panels, glazed add-on panels or doors.
- Must be used with UniGroup Too panels only.

All-Purpose Hook

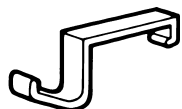

E2CH-8
Class AC

	Number	Trim A	B
	E2CH-8	\$166.40	\$195.74

Features

- Includes eight hooks.
- For use with UniGroup Too square painted top cap panels.

To Order, Specify:

- 1) Product number.
- 2) Trim color.

Seismic Anchoring Bracket

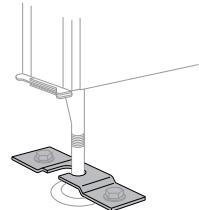

HAB
Class BA

	Number	Price
	HAB-0001	\$333.05

Features

- Includes package of six formed steel brackets.
- For seismic anchoring of UniGroup Too, UniGroup and PLACES panels.

To Order, Specify:

- 1) Product number.
(No finish specification required.)

Friction Pad



7031-0501
Class BA

	7031-0501	\$18.94
--	-----------	---------

Feature

- Includes one pad.

Specification Tip

- Attaches to bottom of glide to prevent movement of panels on hard surface flooring.

To Order, Specify:

- 1) Product number.
(No finish specification required.)

This page intentionally blank

Monolithic Panel with Steel Top Cap — No Power

UniGroup

Fabric

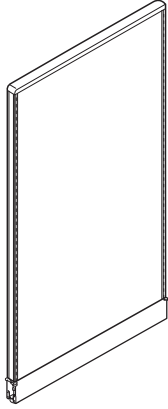

EFN-B (Non-Powered)

NOTE:

This panel has fabric/colorway restrictions, see Systems Fabric/ Color Legend.

Features

- Includes non-powered panel assembly, radius steel top cap, with or without one-piece base raceway cover, 1.6 hinge kits, side trim rails, leveling glides and carpet gripper. .6 base raceway end caps are shipped with each panel. Order additional as necessary.
- Acoustical panel surfaces; fabric surface over 0.5”(13mm) thick fiber board.
- Panel surfaces may have the same fabric on both sides or a different fabric on each side.
- Panel thickness is 2”(51mm).
- Base raceway is 4”(102mm) high.
- Shipped with unassembled top cap, base raceway cover and side trim rails.

Specification Tips

- Panels will accept add-on panels up to a combined height of 82”(2083mm). For aesthetic consistency, specify UniGroup add-on panels.
- Raceway cover must be separately specified for option -BE (no raceway cover).
- Additional base raceway cover end caps will need to be specified if finish posts are not ordered.

To Order, Specify:

- 1) Product number, including:

① Options:

B With Raceway Cover

BE Without Raceway Cover, deduct **\$119.67** list

- 2) Fabric/colorway for panel side one.
- 3) Fabric/colorway for panel side two.
- 4) Trim color for raceway cover, glide housings and end caps.
- 5) Trim color for top cap and side trim rails.

Note: Upcharge for mixed surface grades, refer to the electronic design and specification tools for pricing.

NOTES:

- Non-powered panels ship without receptacle ports in the base raceway cover.
- Some building codes may restrict the use of panel heights greater than 69”(1753mm). Consult your local code authority to assure that the furniture layout is compliant.
- For International Power, specify non-powered panels and use Power Logic components. See Specification Guide for more information on Power Logic.

Monolithic Panel with Steel Top Cap — No Power

UniGroup

Fabric	Actual Height	Width	Number ①	Fabric Grade						
				A	B	C	E	F	G	
30"(762mm)	12"(305mm)	EFN-128-		\$1034.62	\$1083.40	\$1137.08	\$1254.12	\$1332.14	\$1380.94	
	18"(457mm)	EFN-1828-		1171.96	1237.06	1308.98	1465.26	1569.68	1635.16	
	24"(610mm)	EFN-228-		1309.30	1390.72	1480.88	1676.40	1807.22	1889.38	
	30"(762mm)	EFN-3028-		1446.64	1544.38	1652.78	1887.54	2044.76	2143.60	
	36"(914mm)	EFN-328-		1583.98	1698.04	1824.68	2098.68	2282.30	2397.82	
	42"(1067mm)	EFN-4228-		1721.32	1851.70	1996.58	2309.82	2519.84	2652.04	
	48"(1219mm)	EFN-428-		1858.66	2005.36	2168.48	2520.96	2757.38	2906.26	
	54"(1372mm)	EFN-5428-		1996.00	2159.02	2340.38	2732.10	2994.92	3160.48	
	60"(1524mm)	EFN-528-		2133.34	2312.68	2512.28	2943.24	3232.46	3414.70	
	37"(940mm)	12"(305mm)	EFN-135-		\$1108.68	\$1168.10	\$1233.26	\$1375.36	\$1470.18	\$1529.20
18"(457mm)		EFN-1835-		1246.02	1321.76	1405.16	1586.50	1707.72	1783.42	
24"(610mm)		EFN-235-		1383.36	1475.42	1577.06	1797.64	1945.26	2037.64	
30"(762mm)		EFN-3035-		1520.70	1629.08	1748.96	2008.78	2182.80	2291.86	
36"(914mm)		EFN-335-		1658.04	1782.74	1920.86	2219.92	2420.34	2546.08	
42"(1067mm)		EFN-4235-		1795.38	1936.40	2092.76	2431.06	2657.88	2800.30	
48"(1219mm)		EFN-435-		1932.72	2090.06	2264.66	2642.20	2895.42	3054.52	
54"(1372mm)		EFN-5435-		2070.06	2243.72	2436.56	2853.34	3132.96	3308.74	
60"(1524mm)		EFN-535-		2207.40	2397.38	2608.46	3064.48	3370.50	3562.96	
44"(1118mm)		12"(305mm)	EFN-142-		\$1182.74	\$1252.80	\$1329.44	\$1496.60	\$1608.22	\$1677.46
	18"(457mm)	EFN-1842-		1320.08	1406.46	1501.34	1707.74	1845.76	1931.68	
	24"(610mm)	EFN-242-		1457.42	1560.12	1673.24	1918.88	2083.30	2185.90	
	30"(762mm)	EFN-3042-		1594.76	1713.78	1845.14	2130.02	2320.84	2440.12	
	36"(914mm)	EFN-342-		1732.10	1867.44	2017.04	2341.16	2558.38	2694.34	
	42"(1067mm)	EFN-4242-		1869.44	2021.10	2188.94	2552.30	2795.92	2948.56	
	48"(1219mm)	EFN-442-		2006.78	2174.76	2360.84	2763.44	3033.46	3202.78	
	54"(1372mm)	EFN-5442-		2144.12	2328.42	2532.74	2974.58	3271.00	3457.00	
	60"(1524mm)	EFN-542-		2281.46	2482.08	2704.64	3185.72	3508.54	3711.22	
	50"(1270mm)	12"(305mm)	EFN-148-		\$1246.22	\$1325.40	\$1411.88	\$1600.52	\$1726.54	\$1804.54
18"(457mm)		EFN-1848-		1383.56	1479.06	1583.78	1811.66	1964.08	2058.76	
24"(610mm)		EFN-248-		1520.90	1632.72	1755.68	2022.80	2201.62	2312.98	
30"(762mm)		EFN-3048-		1658.24	1786.38	1927.58	2233.94	2439.16	2567.20	
36"(914mm)		EFN-348-		1795.58	1940.04	2099.48	2445.08	2676.70	2821.42	
42"(1067mm)		EFN-4248-		1932.92	2093.70	2271.38	2656.22	2914.24	3075.64	
48"(1219mm)		EFN-448-		2070.26	2247.36	2443.28	2867.36	3151.78	3329.86	
54"(1372mm)		EFN-5448-		2207.60	2401.02	2615.18	3078.50	3389.32	3584.08	
60"(1524mm)		EFN-548-		2344.94	2554.68	2787.08	3289.64	3626.86	3838.30	
56"(1422mm)		12"(305mm)	EFN-154-		\$1309.70	\$1398.00	\$1494.32	\$1704.44	\$1844.86	\$1931.62
	18"(457mm)	EFN-1854-		1447.04	1551.66	1666.22	1915.58	2082.40	2185.84	
	24"(610mm)	EFN-254-		1584.38	1705.32	1838.12	2126.72	2319.94	2440.06	
	30"(762mm)	EFN-3054-		1721.72	1858.98	2010.02	2337.86	2557.48	2694.28	
	36"(914mm)	EFN-354-		1859.06	2012.64	2181.92	2549.00	2795.02	2948.50	
	42"(1067mm)	EFN-4254-		1996.40	2166.30	2353.82	2760.14	3032.56	3202.72	
	48"(1219mm)	EFN-454-		2133.74	2319.96	2525.72	2971.28	3270.10	3456.94	
	54"(1372mm)	EFN-5454-		2271.08	2473.62	2697.62	3182.42	3507.64	3711.16	
	60"(1524mm)	EFN-554-		2408.42	2627.28	2869.52	3393.56	3745.18	3965.38	
	64"(1626mm)	12"(305mm)	EFN-162-		\$1394.34	\$1494.80	\$1604.24	\$1843.00	\$2002.62	\$2101.06
18"(457mm)		EFN-1862-		1531.68	1648.46	1776.14	2054.14	2240.16	2355.28	
24"(610mm)		EFN-262-		1669.02	1802.12	1948.04	2265.28	2477.70	2609.50	
30"(762mm)		EFN-3062-		1806.36	1955.78	2119.94	2476.42	2715.24	2863.72	
36"(914mm)		EFN-362-		1943.70	2109.44	2291.84	2687.56	2952.78	3117.94	
42"(1067mm)		EFN-4262-		2081.04	2263.10	2463.74	2898.70	3190.32	3372.16	
48"(1219mm)		EFN-462-		2218.38	2416.76	2635.64	3109.84	3427.86	3626.38	
54"(1372mm)		EFN-5462-		2355.72	2570.42	2807.54	3320.98	3665.40	3880.60	
60"(1524mm)		EFN-562-		2493.06	2724.08	2979.44	3532.12	3902.94	4134.82	
68"(1727mm)		12"(305mm)	EFN-166-		\$1436.66	\$1543.20	\$1659.20	\$1912.28	\$2081.50	\$2185.78
	18"(457mm)	EFN-1866-		1574.00	1696.86	1831.10	2123.42	2319.04	2440.00	
	24"(610mm)	EFN-266-		1711.34	1850.52	2003.00	2334.56	2556.58	2694.22	
	30"(762mm)	EFN-3066-		1848.68	2004.18	2174.90	2545.70	2794.12	2948.44	
	36"(914mm)	EFN-366-		1986.02	2157.84	2346.80	2756.84	3031.66	3202.66	
	42"(1067mm)	EFN-4266-		2123.36	2311.50	2518.70	2967.98	3269.20	3456.88	
	48"(1219mm)	EFN-466-		2260.70	2465.16	2690.60	3179.12	3506.74	3711.10	
	54"(1372mm)	EFN-5466-		2398.04	2618.82	2862.50	3390.26	3744.28	3965.32	
	60"(1524mm)	EFN-566-		2535.38	2772.48	3034.40	3601.40	3981.82	4219.54	
	82"(2083mm)	12"(305mm)	EFN-180-		\$1608.84	\$1736.66	\$1875.62	\$2178.82	\$2381.64	\$2506.36
18"(457mm)		EFN-1880-		1827.90	1972.04	2129.24	2471.68	2700.90	2842.30	
24"(610mm)		EFN-280-		2046.96	2207.42	2382.86	2764.54	3020.16	3178.24	
30"(762mm)		EFN-3080-		2266.02	2442.80	2636.48	3057.40	3339.42	3514.18	
36"(914mm)		EFN-380-		2485.08	2678.18	2890.10	3350.26	3658.68	3850.12	
42"(1067mm)		EFN-4280-		2704.14	2913.56	3143.72	3643.12	3977.94	4186.06	
48"(1219mm)		EFN-480-		2923.20	3148.94	3397.34	3935.98	4297.20	4522.00	
54"(1372mm)		EFN-5480-		3142.26	3384.32	3650.96	4228.84	4616.46	4857.94	
60"(1524mm)		EFN-580-		3361.32	3619.70	3904.58	4521.70	4935.72	5193.88	

Monolithic Panel with Steel Top Cap — Powered

UniGroup

Fabric

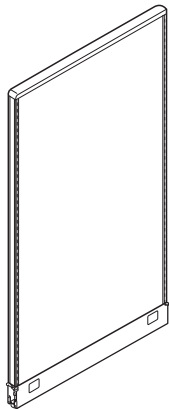

EFP-B (3-circuit)
EFP-2 (4-circuit, 2+2)
EFP-4 (4-circuit, 3+1)



NOTE:

This panel has fabric/colorway restrictions, see Systems Fabric/ Color Legend.

Features

- Includes powered panel assembly, radius steel top cap, with or without one-piece base raceway cover, 1.6 hinge kits, side trim rails, leveling glides and carpet gripper; power distribution assembly/flex connector(s). .6 base raceway end caps are shipped with each panel. Order additional as necessary.
- Acoustical panel surfaces; fabric surface over 0.5”(13mm) thick fiber board.
- Panel surfaces may have the same fabric on both sides or a different fabric on each side.
- Panel thickness is 2”(51mm).
- Base raceway is 4”(102mm) high.
- Powered raceway with or without raceway cover requires modified catalog number and list price.
- Powered panels are available for countries that utilize 120 volt 60 hertz electrical systems and U.S. configured plugs and outlets.
- Shipped with unassembled top cap, base raceway cover and side trim rails.

Specification Tips

- Panels will accept add-on panels up to a combined height of 82”(2083mm). For aesthetic consistency, specify UniGroup add-on panels.
- Flex connectors provided for powered monolithic panels accommodate straight in-line, inside 90°, and inside 120° conditions (if applicable).
- Receptacles for powered panels must be specified separately.
- Raceway cover must be separately specified for option -BE, BYE, 2E, 2YE, 4E or 4YE (no raceway cover).
- Additional base raceway cover end caps will need to be specified if finish posts are not ordered.

To Order, Specify:

1) Product number, including:

① 3-Circuit

- B** With Raceway Cover
- BE** Without Raceway Cover, deduct **\$119.67** list
- BY** NYC with Raceway Cover, add **\$80.16** list
- BYE** NYC without Raceway Cover, deduct **\$39.51** list

4-Circuit, 2+2

- 2** With Raceway Cover, add **\$45.07** list
- 2E** Without Raceway Cover, deduct **\$74.60** list
- 2Y** NYC with Raceway Cover, add **\$125.23** list
- 2YE** NYC without Raceway Cover, deduct **\$5.56** list

4-Circuit, 3+1

- 4** With Raceway Cover, add **\$45.07** list
- 4E** Without Raceway Cover, deduct **\$74.60** list
- 4Y** NYC with Raceway Cover, add **\$125.23** list
- 4YE** NYC without Raceway Cover, deduct **\$9.83** list

- 2) Fabric/colorway for panel side one.
- 3) Fabric/colorway for panel side two.
- 4) Trim color for raceway cover, glide housings and end caps.
- 5) Trim color for top cap and side trim rails.

Note: Upcharge for mixed surface grades, refer to the electronic design and specification tools for pricing.

NOTES:

- Powered panels with raceway covers ship with receptacle ports in the base raceway cover. Receptacle ports on the raceway cover measure 2.35”(60mm) top-to-bottom and 2.88”(73mm) side-to-side.
- Powered panels with Power Distribution Assemblies (PDA) but without raceway covers require separately specified base raceway covers for power and communication port locations other than the standard powered base raceway cover.
- New York City (NYC) electrical applications require field installation of PDA.
- New York Port Authority (NYPA) electrical applications require metal raceway covers. To order, specify NYC powered panels without raceway cover and separately specify metal covers through Haworth eParts.
- Some building codes may restrict the use of panel heights greater than 69”(1753mm). Consult your local code authority to assure that the furniture layout is compliant.
- For International Power, specify non-powered panels and use Power Logic components. See Specification Guide for more information on Power Logic.
- For Chicago power, specify non-powered panels without a base raceway cover and separately specify Chicago power retrofit kit.

Monolithic Panel with Steel Top Cap — Powered

UniGroup

Fabric	Actual Height	Width	Number ^①	Fabric Grade						
				A	B	C	E	F	G	
Fabric	30"(762mm)	12"(305mm)	EFP-128-	\$1389.13	\$1437.91	\$1491.59	\$1608.63	\$1686.65	\$1735.45	
	18"(457mm)	EFP-1828-	1541.86	1606.96	1678.88	1835.16	1939.58	2005.06		
	24"(610mm)	EFP-228-	1679.20	1760.62	1850.78	2046.30	2177.12	2259.28		
	30"(762mm)	EFP-3028-	1816.54	1914.28	2022.68	2257.44	2414.66	2513.50		
	36"(914mm)	EFP-328-	1953.88	2067.94	2194.58	2468.58	2652.20	2767.72		
	42"(1067mm)	EFP-4228-	2091.22	2221.60	2366.48	2679.72	2889.74	3021.94		
	48"(1219mm)	EFP-428-	2228.56	2375.26	2538.38	2890.86	3127.28	3276.16		
	54"(1372mm)	EFP-5428-	2365.90	2528.92	2710.28	3102.00	3364.82	3530.38		
	60"(1524mm)	EFP-528-	2503.24	2682.58	2882.18	3313.14	3602.36	3784.60		
	37"(940mm)	12"(305mm)	EFP-135-	\$1463.19	\$1522.61	\$1587.77	\$1729.87	\$1824.69	\$1883.71	
		18"(457mm)	EFP-1835-	1615.92	1691.66	1775.06	1956.40	2077.62	2153.32	
		24"(610mm)	EFP-235-	1753.26	1845.32	1946.96	2167.54	2315.16	2407.54	
30"(762mm)		EFP-3035-	1890.60	1998.98	2118.86	2378.68	2552.70	2661.76		
36"(914mm)		EFP-335-	2027.94	2152.64	2290.76	2589.82	2790.24	2915.98		
42"(1067mm)		EFP-4235-	2165.28	2306.30	2462.66	2800.96	3027.78	3170.20		
48"(1219mm)		EFP-435-	2302.62	2459.96	2634.56	3102.10	3265.32	3424.42		
54"(1372mm)		EFP-5435-	2439.96	2613.62	2806.46	3223.24	3502.86	3678.64		
60"(1524mm)		EFP-535-	2577.30	2767.28	2978.36	3434.38	3740.40	3932.86		
44"(1118mm)		12"(305mm)	EFP-142-	\$1537.25	\$1607.31	\$1683.95	\$1851.11	\$1962.73	\$2031.97	
		18"(457mm)	EFP-1842-	1689.98	1776.36	1871.24	2077.64	2215.66	2301.58	
		24"(610mm)	EFP-242-	1827.32	1930.02	2043.14	2288.78	2453.20	2555.80	
	30"(762mm)	EFP-3042-	1964.66	2083.68	2215.04	2499.92	2690.74	2810.02		
	36"(914mm)	EFP-342-	2102.00	2237.34	2386.94	2711.06	2928.28	3064.24		
	42"(1067mm)	EFP-4242-	2239.34	2391.00	2558.84	2922.20	3165.82	3318.46		
	48"(1219mm)	EFP-442-	2376.68	2544.66	2730.74	3133.34	3403.36	3572.68		
	54"(1372mm)	EFP-5442-	2514.02	2698.32	2902.64	3344.48	3640.90	3826.90		
	60"(1524mm)	EFP-542-	2651.36	2851.98	3074.54	3555.62	3878.44	4081.12		
	50"(1270mm)	12"(305mm)	EFP-148-	\$1600.73	\$1679.91	\$1766.39	\$1955.03	\$2081.05	\$2159.05	
		18"(457mm)	EFP-1848-	1753.46	1848.96	1953.68	2181.56	2333.98	2428.66	
		24"(610mm)	EFP-248-	1890.80	2002.62	2125.58	2392.70	2571.52	2682.88	
30"(762mm)		EFP-3048-	2028.14	2156.28	2297.48	2603.84	2809.06	2937.10		
36"(914mm)		EFP-348-	2165.48	2309.94	2469.38	2814.98	3046.60	3191.32		
42"(1067mm)		EFP-4248-	2302.82	2463.60	2641.28	3026.12	3284.14	3445.54		
48"(1219mm)		EFP-448-	2440.16	2617.26	2813.18	3237.26	3521.68	3699.76		
54"(1372mm)		EFP-5448-	2577.50	2770.92	2985.08	3448.40	3759.22	3953.98		
60"(1524mm)		EFP-548-	2714.84	2924.58	3156.98	3659.54	3996.76	4208.20		
56"(1422mm)		12"(305mm)	EFP-154-	\$1664.21	\$1752.51	\$1848.83	\$2058.95	\$2199.37	\$2286.13	
		18"(457mm)	EFP-1854-	1816.94	1921.56	2036.12	2285.48	2452.30	2555.74	
		24"(610mm)	EFP-254-	1954.28	2075.22	2208.02	2496.62	2689.84	2809.96	
	30"(762mm)	EFP-3054-	2091.62	2228.88	2379.92	2707.76	2927.38	3064.18		
	36"(914mm)	EFP-354-	2228.96	2382.54	2551.82	2918.90	3164.92	3318.40		
	42"(1067mm)	EFP-4254-	2366.30	2536.20	2723.72	3130.04	3402.46	3572.62		
	48"(1219mm)	EFP-454-	2503.64	2689.86	2895.62	3341.18	3640.00	3826.84		
	54"(1372mm)	EFP-5454-	2640.98	2843.52	3067.52	3552.32	3877.54	4081.06		
	60"(1524mm)	EFP-554-	2778.32	2997.18	3239.42	3763.46	4115.08	4335.28		
	64"(1626mm)	12"(305mm)	EFP-162-	\$1748.85	\$1849.31	\$1958.75	\$2197.51	\$2357.13	\$2455.57	
		18"(457mm)	EFP-1862-	1901.58	2018.36	2146.04	2424.04	2610.06	2725.18	
		24"(610mm)	EFP-262-	2038.92	2172.02	2317.94	2635.18	2847.60	2979.40	
30"(762mm)		EFP-3062-	2176.26	2325.68	2489.84	2846.32	3085.14	3233.62		
36"(914mm)		EFP-362-	2313.60	2479.34	2661.74	3057.46	3322.68	3487.84		
42"(1067mm)		EFP-4262-	2450.94	2633.00	2833.64	3268.60	3560.22	3742.06		
48"(1219mm)		EFP-462-	2588.28	2786.66	3005.54	3479.74	3797.76	3996.28		
54"(1372mm)		EFP-5462-	2725.62	2940.32	3177.44	3690.88	4035.30	4250.50		
60"(1524mm)		EFP-562-	2862.96	3093.98	3349.34	3902.02	4272.84	4504.72		
68"(1727mm)		12"(305mm)	EFP-166-	\$1791.17	\$1897.71	\$2013.71	\$2266.79	\$2436.01	\$2540.29	
		18"(457mm)	EFP-1866-	1943.90	2066.76	2201.00	2493.32	2688.94	2809.90	
		24"(610mm)	EFP-266-	2081.24	2220.42	2372.90	2704.46	2926.48	3064.12	
	30"(762mm)	EFP-3066-	2218.58	2374.08	2544.80	2915.60	3164.02	3318.34		
	36"(914mm)	EFP-366-	2355.92	2527.74	2716.70	3126.74	3401.56	3572.56		
	42"(1067mm)	EFP-4266-	2493.26	2681.40	2888.60	3337.88	3639.10	3826.78		
	48"(1219mm)	EFP-466-	2630.60	2835.06	3060.50	3549.02	3876.64	4081.00		
	54"(1372mm)	EFP-5466-	2767.94	2988.72	3232.40	3760.16	4114.18	4335.22		
	60"(1524mm)	EFP-566-	2905.28	3142.38	3404.30	3971.30	4351.72	4589.44		
	82"(2083mm)	12"(305mm)	EFP-180-	\$1963.35	\$2091.17	\$2230.13	\$2533.33	\$2736.15	\$2860.87	
		18"(457mm)	EFP-1880-	2197.80	2341.94	2499.14	2841.58	3070.80	3212.20	
		24"(610mm)	EFP-280-	2416.86	2577.32	2752.76	3134.44	3390.06	3548.14	
30"(762mm)		EFP-3080-	2635.92	2812.70	3006.38	3427.30	3709.32	3884.08		
36"(914mm)		EFP-380-	2854.98	3048.08	3260.00	3720.16	4028.58	4220.02		
42"(1067mm)		EFP-4280-	3074.04	3283.46	3513.62	4013.02	4347.84	4555.96		
48"(1219mm)		EFP-480-	3293.10	3518.84	3767.24	4305.88	4667.10	4891.90		
54"(1372mm)		EFP-5480-	3512.16	3754.22	4020.86	4598.74	4986.36	5227.84		
60"(1524mm)		EFP-580-	3731.22	3989.60	4274.48	4891.60	5305.62	5563.78		

Basic Monolithic Panel with Steel Top Cap — No Power

UniGroup

Fabric

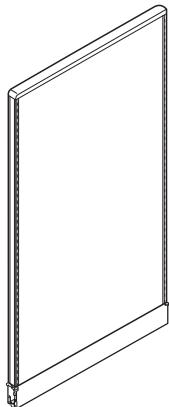

EMN-B (Non-Powered)

Features

- Includes non-powered panel assembly, radius steel top cap, with or without one-piece base raceway cover, 1.6 hinge kits, side trim rails, leveling glides and carpet gripper. .6 base raceway end caps are shipped with each panel. Order additional as necessary.
- Acoustical panel surfaces; fabric surface over 0.25"(6mm) thick fiber board.
- Panel surfaces may have the same fabric on both sides or a different fabric on each side.
- Panel thickness is 2"(51mm).
- Shipped with unassembled top cap, base raceway cover and side trim rails.

Specification Tips

- Panels will accept add-on panels up to a combined height of 82"(2083mm). For aesthetic consistency, specify UniGroup add-on panels.
- Raceway cover must be separately specified for option -BE (no raceway cover).
- Additional base raceway cover end caps will need to be specified if finish posts are not ordered.

To Order, Specify:

- 1) Product number, including:

① Options:

B With Raceway Cover

BE Without Raceway Cover, deduct **\$119.67** list

- 2) Fabric/colorway for panel side one.
- 3) Fabric/colorway for panel side two.
- 4) Trim color for raceway cover, glide housings and end caps.
- 5) Trim color for top cap and side trim rails.

Note: Upcharge for mixed surface grades, refer to the electronic design and specification tools for pricing.

NOTE:

This panel has fabric/colorway restrictions, see Systems Fabric/ Color Legend.

NOTES:

- Non-powered panels ship without receptacle ports in the base raceway cover.
- Some building codes may restrict the use of panel heights greater than 69"(1753mm). Consult your local code authority to assure that the furniture layout is compliant.
- For International Power, specify non-powered panels and use Power Logic components. See Specification Guide for more information on Power Logic.
- For Chicago power, specify non-powered panels without a base raceway cover and separately specify Chicago power retrofit kit.

Basic Monolithic Panel with Steel Top Cap — No Power

UniGroup

Fabric	Actual Height	Width	Number ①	Fabric Grade						
				A	B	C	E	F	G	
	30"(762mm)	12"(305mm)	EMN-128-	\$ 850.25	\$ 899.03	\$ 952.71	\$ 1069.75	\$ 1147.77	\$ 1196.57	
		18"(457mm)	EMN-1828-	958.73	1023.83	1095.75	1252.03	1356.45	1421.93	
		24"(610mm)	EMN-228-	1067.21	1148.63	1238.79	1434.31	1565.13	1647.29	
		30"(762mm)	EMN-3028-	1175.69	1273.43	1381.83	1616.59	1773.81	1872.65	
		36"(914mm)	EMN-328-	1284.17	1398.23	1524.87	1798.87	1982.49	2098.01	
		42"(1067mm)	EMN-4228-	1392.65	1523.03	1667.91	1981.15	2191.17	2323.37	
		48"(1219mm)	EMN-428-	1501.13	1647.83	1810.95	2163.43	2399.85	2548.73	
		54"(1372mm)	EMN-5428-	1609.61	1772.63	1953.99	2345.71	2608.53	2774.09	
		60"(1524mm)	EMN-528-	1718.09	1897.43	2097.03	2527.99	2817.21	2999.45	
	37"(940mm)	12"(305mm)	EMN-135-	\$ 918.71	\$ 978.13	\$ 1043.29	\$ 1185.39	\$ 1280.21	\$ 1339.23	
		18"(457mm)	EMN-1835-	1027.19	1102.93	1186.33	1367.67	1488.89	1564.59	
		24"(610mm)	EMN-235-	1135.67	1227.73	1329.37	1549.95	1697.57	1789.95	
		30"(762mm)	EMN-3035-	1244.15	1352.53	1472.41	1732.23	1906.25	2015.31	
		36"(914mm)	EMN-335-	1352.63	1477.33	1615.45	1914.51	2114.93	2240.67	
		42"(1067mm)	EMN-4235-	1461.11	1602.13	1758.49	2096.79	2323.61	2466.03	
		48"(1219mm)	EMN-435-	1569.59	1726.93	1901.53	2279.07	2532.29	2691.39	
		54"(1372mm)	EMN-5435-	1678.07	1851.73	2044.57	2461.35	2740.97	2916.75	
		60"(1524mm)	EMN-535-	1786.55	1976.53	2187.61	2643.63	2949.65	3142.11	
	44"(1118mm)	12"(305mm)	EMN-142-	\$ 987.17	\$ 1057.23	\$ 1133.87	\$ 1301.03	\$ 1412.65	\$ 1481.89	
		18"(457mm)	EMN-1842-	1095.65	1182.03	1276.91	1483.31	1621.33	1707.25	
		24"(610mm)	EMN-242-	1204.13	1306.83	1419.95	1665.59	1830.01	1932.61	
		30"(762mm)	EMN-3042-	1312.61	1431.63	1562.99	1847.87	2038.69	2157.97	
		36"(914mm)	EMN-342-	1421.09	1556.43	1706.03	2030.15	2247.37	2383.33	
		42"(1067mm)	EMN-4242-	1529.57	1681.23	1849.07	2212.43	2456.05	2608.69	
		48"(1219mm)	EMN-442-	1638.05	1806.03	1992.11	2394.71	2664.73	2834.05	
		54"(1372mm)	EMN-5442-	1746.53	1930.83	2135.15	2576.99	2873.41	3059.41	
		60"(1524mm)	EMN-542-	1855.01	2055.63	2278.19	2759.27	3082.09	3284.77	
	50"(1270mm)	12"(305mm)	EMN-148-	\$ 1045.85	\$ 1125.03	\$ 1211.51	\$ 1400.15	\$ 1526.17	\$ 1604.17	
		18"(457mm)	EMN-1848-	1154.33	1249.83	1354.55	1582.43	1734.85	1829.53	
		24"(610mm)	EMN-248-	1262.81	1374.63	1497.59	1764.71	1943.53	2054.89	
		30"(762mm)	EMN-3048-	1371.29	1499.43	1640.63	1946.99	2152.21	2280.25	
		36"(914mm)	EMN-348-	1479.77	1624.23	1783.67	2129.27	2360.89	2505.61	
		42"(1067mm)	EMN-4248-	1588.25	1749.03	1926.71	2311.55	2569.57	2730.97	
		48"(1219mm)	EMN-448-	1696.73	1873.83	2069.75	2493.83	2778.25	2956.33	
		54"(1372mm)	EMN-5448-	1805.21	1998.63	2212.79	2676.11	2986.93	3181.69	
		60"(1524mm)	EMN-548-	1913.69	2123.43	2355.83	2858.39	3195.61	3407.05	
	56"(1422mm)	12"(305mm)	EMN-154-	\$ 1104.53	\$ 1192.83	\$ 1289.15	\$ 1499.27	\$ 1639.69	\$ 1726.45	
		18"(457mm)	EMN-1854-	1213.01	1317.63	1432.19	1681.55	1848.37	1951.81	
		24"(610mm)	EMN-254-	1321.49	1442.43	1575.23	1863.83	2057.05	2177.17	
		30"(762mm)	EMN-3054-	1429.97	1567.23	1718.27	2046.11	2265.73	2402.53	
		36"(914mm)	EMN-354-	1538.45	1692.03	1861.31	2228.39	2474.41	2627.89	
		42"(1067mm)	EMN-4254-	1646.93	1816.83	2004.35	2410.67	2683.09	2853.25	
		48"(1219mm)	EMN-454-	1755.41	1941.63	2147.39	2592.95	2891.77	3078.61	
		54"(1372mm)	EMN-5454-	1863.89	2066.43	2290.43	2775.23	3100.45	3303.97	
		60"(1524mm)	EMN-554-	1972.37	2191.23	2433.47	2957.51	3309.13	3529.33	
	64"(1626mm)	12"(305mm)	EMN-162-	\$ 1182.77	\$ 1283.23	\$ 1392.67	\$ 1631.43	\$ 1791.05	\$ 1889.49	
		18"(457mm)	EMN-1862-	1291.25	1408.03	1535.71	1813.71	1999.73	2114.85	
		24"(610mm)	EMN-262-	1399.73	1532.83	1678.75	1995.99	2208.41	2340.21	
		30"(762mm)	EMN-3062-	1508.21	1657.63	1821.79	2178.27	2417.09	2565.57	
		36"(914mm)	EMN-362-	1616.69	1782.43	1964.83	2360.55	2625.77	2790.93	
		42"(1067mm)	EMN-4262-	1725.17	1907.23	2107.87	2542.83	2834.45	3016.29	
		48"(1219mm)	EMN-462-	1833.65	2032.03	2250.91	2725.11	3043.13	3241.65	
		54"(1372mm)	EMN-5462-	1942.13	2156.83	2393.95	2907.39	3251.81	3467.01	
		60"(1524mm)	EMN-562-	2050.61	2281.63	2536.99	3089.67	3460.49	3692.37	
	68"(1727mm)	12"(305mm)	EMN-166-	\$ 1221.89	\$ 1328.43	\$ 1444.43	\$ 1697.51	\$ 1866.73	\$ 1971.01	
		18"(457mm)	EMN-1866-	1330.37	1453.23	1587.47	1879.79	2075.41	2196.37	
		24"(610mm)	EMN-266-	1438.85	1578.03	1730.51	2062.07	2284.09	2421.73	
		30"(762mm)	EMN-3066-	1547.33	1702.83	1873.55	2244.35	2492.77	2647.09	
		36"(914mm)	EMN-366-	1655.81	1827.63	2016.59	2426.63	2701.45	2872.45	
		42"(1067mm)	EMN-4266-	1764.29	1952.43	2159.63	2608.91	2910.13	3097.81	
		48"(1219mm)	EMN-466-	1872.77	2077.23	2302.67	2791.19	3118.81	3323.17	
		54"(1372mm)	EMN-5466-	1981.25	2202.03	2445.71	2973.47	3327.49	3548.53	
		60"(1524mm)	EMN-566-	2089.73	2326.83	2588.75	3155.75	3536.17	3773.89	
	82"(2083mm)	12"(305mm)	EMN-180-	\$ 1382.87	\$ 1510.69	\$ 1649.65	\$ 1952.85	\$ 2155.67	\$ 2280.39	
		18"(457mm)	EMN-1880-	1573.07	1717.21	1874.41	2216.85	2446.07	2587.47	
		24"(610mm)	EMN-280-	1763.27	1923.73	2099.17	2480.85	2736.47	2894.55	
		30"(762mm)	EMN-3080-	1953.47	2130.25	2323.93	2744.85	3026.87	3201.63	
		36"(914mm)	EMN-380-	2143.67	2336.77	2548.69	3008.85	3317.27	3508.71	
		42"(1067mm)	EMN-4280-	2333.87	2543.29	2773.45	3272.85	3607.67	3815.79	
		48"(1219mm)	EMN-480-	2524.07	2749.81	2998.21	3536.85	3898.07	4122.87	
		54"(1372mm)	EMN-5480-	2714.27	2956.33	3222.97	3800.85	4188.47	4429.95	
		60"(1524mm)	EMN-580-	2904.47	3162.85	3447.73	4064.85	4478.87	4737.03	

Basic Monolithic Panel with Steel Top Cap — Powered

UniGroup

Fabric

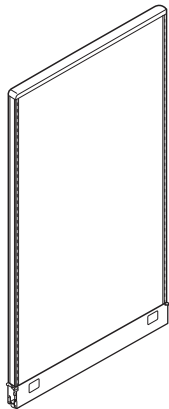

EMP-B (3-circuit)
EMP-2 (4-circuit, 2+2)
EMP-4 (4-circuit, 3+1)



NOTE:

This panel has fabric/colorway restrictions, see Systems Fabric/ Color Legend.

Features

- Includes powered panel assembly, radius steel top cap, with or without one-piece base raceway cover, 1.6 hinge kits, side trim rails, leveling glides and carpet gripper; power distribution assembly/flex connector(s). .6 base raceway end caps are shipped with each panel. Order additional as necessary.
- Acoustical panel surfaces; fabric surface over 0.25" (6mm) thick fiber board.
- Panel surfaces may have the same fabric on both sides or a different fabric on each side.
- Panel thickness is 2" (51mm).
- Base raceway is 4" (102mm) high.
- Powered raceway with or without raceway cover requires modified catalog number and list price.
- Powered panels are available for countries that utilize 120 volt 60 hertz electrical systems and U.S. configured plugs and outlets.
- Shipped with unassembled top cap, base raceway cover and side trim rails.

Specification Tips

- Panels will accept add-on panels up to a combined height of 82" (2083mm). For aesthetic consistency, specify UniGroup add-on panels.
- Flex connectors provided for powered monolithic panels accommodate straight in-line, inside 90°, and inside 120° conditions (if applicable).
- Receptacles for powered panels must be specified separately.
- Raceway cover must be separately specified for option -BE, BYE, 2E, 2YE, 4E or 4YE (no raceway cover).
- Additional base raceway cover end caps will need to be specified if finish posts are not ordered.

To Order, Specify:

1) Product number, including:

① 3-Circuit

- B** With Raceway Cover
- BE** Without Raceway Cover, deduct **\$119.67** list
- BY** NYC with Raceway Cover, add **\$80.16** list
- BYE** NYC without Raceway Cover, deduct **\$39.51** list

4-Circuit, 2+2

- 2** With Raceway Cover, add **\$45.07** list
- 2E** Without Raceway Cover, deduct **\$89.99** list
- 2Y** NYC with Raceway Cover, add **\$125.23** list
- 2YE** NYC without Raceway Cover, deduct **\$9.83** list

4-Circuit, 3+1

- 4** With Raceway Cover, add **\$45.07** list
- 4E** Without Raceway Cover, deduct **\$89.99** list
- 4Y** NYC with Raceway Cover, add **\$125.23** list
- 4YE** NYC without Raceway Cover, deduct **\$9.83** list

- 2) Fabric/colorway for panel side one.
- 3) Fabric/colorway for panel side two.
- 4) Trim color for raceway cover, glide housings and end caps.
- 5) Trim color for top cap and side trim rails.

Note: Upcharge for mixed surface grades, refer to the electronic design and specification tools for pricing.

NOTES:

- Powered panels with raceway covers ship with receptacle ports in the base raceway cover. Receptacle ports on the raceway cover measure 2.35" (60mm) top-to-bottom and 2.88" (73mm) side-to-side.
- Powered panels with Power Distribution Assemblies (PDA) but without raceway covers require separately specified base raceway covers for power and communication port locations other than the standard powered base raceway cover.
- New York City (NYC) electrical applications require field installation of PDA.
- New York Port Authority (NYPA) electrical applications require metal raceway covers. To order, specify NYC powered panels without raceway cover and separately specify metal covers through Haworth eParts.
- Some building codes may restrict the use of panel heights greater than 69" (1753mm). Consult your local code authority to assure that the furniture layout is compliant.
- For International Power, specify non-powered panels and use Power Logic components. See Specification Guide for more information on Power Logic.
- For Chicago power, specify non-powered panels without a base raceway cover and separately specify Chicago power retrofit kit.

Basic Monolithic Panel with Steel Top Cap — Powered

UniGroup

Fabric	Actual Height	Width	Number ①	Fabric Grade						
				A	B	C	E	F	G	
30"(762mm)	12"(305mm)	EMP-128-		\$1204.76	\$1253.54	\$1307.22	\$1424.26	\$1502.28	\$1551.08	
	18"(457mm)	EMP-1828-		1328.63	1393.73	1465.65	1621.93	1726.35	1791.83	
	24"(610mm)	EMP-228-		1437.11	1518.53	1608.69	1804.21	1935.03	2017.19	
	30"(762mm)	EMP-3028-		1545.59	1643.33	1751.73	1986.49	2143.71	2242.55	
	36"(914mm)	EMP-328-		1654.07	1768.13	1894.77	2168.77	2352.39	2467.91	
	42"(1067mm)	EMP-4228-		1762.55	1892.93	2037.81	2351.05	2561.07	2693.27	
	48"(1219mm)	EMP-428-		1871.03	2017.73	2180.85	2533.33	2769.75	2918.63	
	54"(1372mm)	EMP-5428-		1979.51	2142.53	2323.89	2715.61	2978.43	3143.99	
	60"(1524mm)	EMP-528-		2087.99	2267.33	2466.93	2897.89	3187.11	3369.35	
	37"(940mm)	12"(305mm)	EMP-135-		\$1273.22	\$1332.64	\$1397.80	\$1539.90	\$1634.72	\$1693.74
		18"(457mm)	EMP-1835-		1397.09	1472.83	1556.23	1737.57	1858.79	1934.49
24"(610mm)		EMP-235-		1505.57	1597.63	1699.27	1919.85	2067.47	2159.85	
30"(762mm)		EMP-3035-		1614.05	1722.43	1842.31	2102.13	2276.15	2385.21	
36"(914mm)		EMP-335-		1722.53	1847.23	1985.35	2284.41	2484.83	2610.57	
42"(1067mm)		EMP-4235-		1831.01	1972.03	2128.39	2466.69	2693.51	2835.93	
48"(1219mm)		EMP-435-		1939.49	2096.83	2271.43	2648.97	2902.19	3061.29	
54"(1372mm)		EMP-5435-		2047.97	2221.63	2414.47	2831.25	3110.87	3286.65	
60"(1524mm)		EMP-535-		2156.45	2346.43	2557.51	3013.53	3319.55	3512.01	
44"(1118mm)		12"(305mm)	EMP-142-		\$1341.68	\$1411.74	\$1488.38	\$1655.54	\$1767.16	\$1836.40
		18"(457mm)	EMP-1842-		1465.55	1551.93	1646.81	1853.21	1991.23	2077.15
	24"(610mm)	EMP-242-		1574.03	1676.73	1789.85	2035.49	2199.91	2302.51	
	30"(762mm)	EMP-3042-		1682.51	1801.53	1932.89	2217.77	2408.59	2527.87	
	36"(914mm)	EMP-342-		1790.99	1926.33	2075.93	2400.05	2617.27	2753.23	
	42"(1067mm)	EMP-4242-		1899.47	2051.13	2218.97	2582.33	2825.95	2978.59	
	48"(1219mm)	EMP-442-		2007.95	2175.93	2362.01	2764.61	3034.63	3203.95	
	54"(1372mm)	EMP-5442-		2116.43	2300.73	2505.05	2946.89	3243.31	3429.31	
	60"(1524mm)	EMP-542-		2224.91	2425.53	2648.09	3129.17	3451.99	3654.67	
	50"(1270mm)	12"(305mm)	EMP-148-		\$1400.36	\$1479.54	\$1566.02	\$1754.66	\$1880.68	\$1958.68
		18"(457mm)	EMP-1848-		1524.23	1619.73	1724.45	1952.33	2104.75	2199.43
24"(610mm)		EMP-248-		1632.71	1744.53	1867.49	2134.61	2313.43	2424.79	
30"(762mm)		EMP-3048-		1741.19	1869.33	2010.53	2316.89	2522.11	2650.15	
36"(914mm)		EMP-348-		1849.67	1994.13	2153.57	2499.17	2730.79	2875.51	
42"(1067mm)		EMP-4248-		1958.15	2118.93	2296.61	2681.45	2939.47	3100.87	
48"(1219mm)		EMP-448-		2066.63	2243.73	2439.65	2863.73	3148.15	3326.23	
54"(1372mm)		EMP-5448-		2175.11	2368.53	2582.69	3046.01	3356.83	3551.59	
60"(1524mm)		EMP-548-		2283.59	2493.33	2725.73	3228.29	3565.51	3776.95	
56"(1422mm)		12"(305mm)	EMP-154-		\$1459.04	\$1547.34	\$1643.66	\$1853.78	\$1994.20	\$2080.96
		18"(457mm)	EMP-1854-		1582.91	1687.53	1802.09	2051.45	2218.27	2321.71
	24"(610mm)	EMP-254-		1691.39	1812.33	1945.13	2233.73	2426.95	2547.07	
	30"(762mm)	EMP-3054-		1799.87	1937.13	2088.17	2416.01	2635.63	2772.43	
	36"(914mm)	EMP-354-		1908.35	2061.93	2231.21	2598.29	2844.31	2997.79	
	42"(1067mm)	EMP-4254-		2016.83	2186.73	2374.25	2780.57	3052.99	3223.15	
	48"(1219mm)	EMP-454-		2125.31	2311.53	2517.29	2962.85	3261.67	3448.51	
	54"(1372mm)	EMP-5454-		2233.79	2436.33	2660.33	3145.13	3470.35	3673.87	
	60"(1524mm)	EMP-554-		2342.27	2561.13	2803.37	3327.41	3679.03	3899.23	
	64"(1626mm)	12"(305mm)	EMP-162-		\$1537.28	\$1637.74	\$1747.18	\$1985.94	\$2145.56	\$2244.00
		18"(457mm)	EMP-1862-		1661.15	1777.93	1905.61	2183.61	2369.63	2484.75
24"(610mm)		EMP-262-		1769.63	1902.73	2048.65	2365.89	2578.31	2710.11	
30"(762mm)		EMP-3062-		1878.11	2027.53	2191.69	2548.17	2786.99	2935.47	
36"(914mm)		EMP-362-		1986.59	2152.33	2334.73	2730.45	2995.67	3160.83	
42"(1067mm)		EMP-4262-		2095.07	2277.13	2477.77	2912.73	3204.35	3386.19	
48"(1219mm)		EMP-462-		2203.55	2401.93	2620.81	3095.01	3413.03	3611.55	
54"(1372mm)		EMP-5462-		2312.03	2526.73	2763.85	3277.29	3621.71	3836.91	
60"(1524mm)		EMP-562-		2420.51	2651.53	2906.89	3459.57	3830.39	4062.27	
68"(1727mm)		12"(305mm)	EMP-166-		\$1576.40	\$1682.94	\$1798.94	\$2052.02	\$2221.24	\$2325.52
		18"(457mm)	EMP-1866-		1700.27	1823.13	1957.37	2249.69	2445.31	2566.27
	24"(610mm)	EMP-266-		1808.75	1947.93	2100.41	2431.97	2653.99	2791.63	
	30"(762mm)	EMP-3066-		1917.23	2072.73	2243.45	2614.25	2862.67	3016.99	
	36"(914mm)	EMP-366-		2025.71	2197.53	2386.49	2796.53	3071.35	3242.35	
	42"(1067mm)	EMP-4266-		2134.19	2322.33	2529.53	2978.81	3280.03	3467.71	
	48"(1219mm)	EMP-466-		2242.67	2447.13	2672.57	3161.09	3488.71	3693.07	
	54"(1372mm)	EMP-5466-		2351.15	2571.93	2815.61	3343.37	3697.39	3918.43	
	60"(1524mm)	EMP-566-		2459.63	2696.73	2958.65	3525.65	3906.07	4143.79	
	82"(2083mm)	12"(305mm)	EMP-180-		\$1737.38	\$1865.20	\$2004.16	\$2307.36	\$2510.18	\$2634.90
		18"(457mm)	EMP-1880-		1942.97	2087.11	2244.31	2586.75	2815.97	2957.37
24"(610mm)		EMP-280-		2133.17	2293.63	2469.07	2850.75	3106.37	3264.45	
30"(762mm)		EMP-3080-		2323.37	2500.15	2693.83	3114.75	3396.77	3571.53	
36"(914mm)		EMP-380-		2513.57	2706.67	2918.59	3378.75	3687.17	3878.61	
42"(1067mm)		EMP-4280-		2703.77	2913.19	3143.35	3642.75	3977.57	4185.69	
48"(1219mm)		EMP-480-		2893.97	3119.71	3368.11	3906.75	4267.97	4492.77	
54"(1372mm)		EMP-5480-		3084.17	3326.23	3592.87	4170.75	4558.37	4799.85	
60"(1524mm)		EMP-580-		3274.37	3532.75	3817.63	4434.75	4848.77	5106.93	

Laminate Monolithic Panel with Steel Top Cap — No Power

UniGroup

Laminate

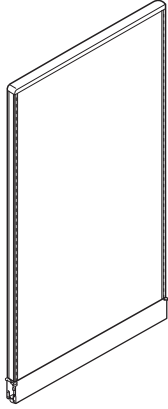

EDN-B (Non-Powered)

Features

- Includes non-powered panel assembly, radius steel top cap, with or without one-piece base raceway cover, 1.6 hinge kits, side trim rails, leveling glides and carpet gripper. **.6** base raceway end caps are shipped with each panel. Order additional as necessary.
- Panel surfaces may have same laminate on both sides or a different laminate on each side.
- Panel thickness is 2"(51mm).
- Base raceway is 4"(102mm) high.
- Shipped with unassembled top cap, base raceway cover and side trim rails.

Specification Tips

- Panels will accept add-on panels up to a combined height of 82"(2083mm). For aesthetic consistency, specify UniGroup add-on panels.
- Raceway cover must be separately specified for option -BE (no raceway cover).
- Additional base raceway cover end caps will need to be specified if finish posts are not ordered.

To Order, Specify:

- 1) Product number, including:

① Options:

B With Raceway Cover

BE Without Raceway Cover, add **\$119.67** list

- 2) Laminate surface color for panel side one.
- 3) Laminate surface color for panel side two.
- 4) Trim color for raceway cover, hinge housings and end caps.
- 5) Trim color for top cap and side trim rails.

Note: Upcharge for raised surface grades, refer to the electronic design and specification tool for pricing.

NOTES:

- Non-powered panels ship without receptacle ports in the base raceway cover.
- Some building codes may restrict the use of panel heights greater than 69"(1753mm). Consult your local code authority to ensure that the furniture layout is compliant.
- For International Power, specify non-powered panels and use Power Logic components. See Specification Guide for more information on Power Logic.
- For Chicago power, specify non-powered panels without a base raceway cover and separately specify Chicago power retrofit kit.

OBSOLETE!

April 2024

Laminate Monolithic Panel with Steel Top Cap — No Power

UniGroup

Laminate	Actual Height	Width	Number ①	Laminate			
				A	B		
37"(940mm)	12"(305mm)	12"(305mm)	EDN-135- [] []	\$1565.43	\$1622.43		
		18"(457mm)	EDN-1835- [] []	1728.99	1799.01		
		24"(610mm)	EDN-235- [] []	1892.55	1975.59		
		30"(762mm)	EDN-3035- [] []	2056.11	2152.17		
		36"(914mm)	EDN-335- [] []	2219.67	2328.75		
		42"(1067mm)	EDN-4235- [] []	2383.23	2505.33		
		48"(1219mm)	EDN-435- [] []	2546.79	2681.91		
		60"(1524mm)	EDN-535- [] []	2873.91	3035.07		
		44"(1118mm)	12"(305mm)	EDN-142- [] []	\$1711.45	\$1779.93	
				18"(457mm)	EDN-1842- [] []	1875.01	1956.51
				24"(610mm)	EDN-242- [] []	2038.57	2133.09
				30"(762mm)	EDN-3042- [] []	2202.13	2309.67
36"(914mm)	EDN-342- [] []			2365.69	2486.25		
42"(1067mm)	EDN-424- [] []			2529.25	2662.83		
44"(1118mm)	18"(457mm)	EDN-442- [] []	2692.81	2839.41			
		24"(610mm)	EDN-542- [] []	3019.93	3192.57		
		30"(762mm)	EDN-142- [] []	\$1836.61	\$1914.93		
		36"(914mm)	EDN-184- [] []	2000.17	2091.51		
		42"(1067mm)	EDN-248- [] []	2163.73	2268.09		
		48"(1219mm)	EDN-3048- [] []	2327.29	2444.67		
50"(1270mm)	36"(914mm)	EDN-348- [] []	2490.85	2621.25			
		42"(1067mm)	EDN-4248- [] []	2654.41	2797.83		
		48"(1219mm)	EDN-448- [] []	2817.97	2974.41		
		60"(1524mm)	EDN-548- [] []	3145.09	3327.57		
		56"(1422mm)	12"(305mm)	EDN-154- [] []	\$1961.77	\$2049.93	
				18"(457mm)	EDN-1854- [] []	2125.33	2226.51
24"(610mm)	EDN-254- [] []			2288.89	2403.09		
30"(762mm)	EDN-3054- [] []			2452.45	2579.67		
36"(914mm)	EDN-354- [] []			2616.01	2756.25		
42"(1067mm)	EDN-4254- [] []			2779.57	2932.83		
56"(1422mm)	48"(1219mm)	EDN-454- [] []	2943.13	3109.41			
		60"(1524mm)	EDN-554- [] []	3270.25	3462.57		
		64"(1625mm)	12"(305mm)	EDN-162- [] []	\$2128.65	\$2229.93	
				18"(457mm)	EDN-1862- [] []	2292.21	2406.51
				24"(610mm)	EDN-262- [] []	2455.77	2583.09
				30"(762mm)	EDN-3062- [] []	2619.33	2759.67
36"(914mm)	EDN-362- [] []			2782.89	2936.25		
42"(1067mm)	EDN-4262- [] []			2946.45	3112.83		
64"(1625mm)	48"(1219mm)	EDN-462- [] []	3110.01	3289.41			
		60"(1524mm)	EDN-562- [] []	3437.13	3642.57		
		68"(1727mm)	12"(305mm)	EDN-166- [] []	\$2212.09	\$2319.93	
				18"(457mm)	EDN-1866- [] []	2375.65	2496.51
				24"(610mm)	EDN-266- [] []	2539.21	2673.09
				30"(762mm)	EDN-3066- [] []	2702.77	2849.67
36"(914mm)	EDN-366- [] []			2866.33	3026.25		
42"(1067mm)	EDN-4266- [] []			3029.89	3202.83		
68"(1727mm)	48"(1219mm)	EDN-466- [] []	3193.45	3379.41			
		60"(1524mm)	EDN-566- [] []	3520.57	3732.57		
		82"(2083mm)	12"(305mm)	EDN-180- [] []	\$2560.27	\$2691.07	
				18"(457mm)	EDN-1880- [] []	2848.99	2992.81
				24"(610mm)	EDN-280- [] []	3137.71	3294.55
				30"(762mm)	EDN-3080- [] []	3426.43	3596.29
36"(914mm)	EDN-380- [] []			3715.15	3898.03		
42"(1067mm)	EDN-4280- [] []			4003.87	4199.77		
82"(2083mm)	48"(1219mm)	EDN-480- [] []	4292.59	4501.51			
		60"(1524mm)	EDN-580- [] []	4870.03	5104.99		

OBSOLETE! April 2024



Laminate Monolithic Panel with Steel Top Cap — Powered

UniGroup

Laminate

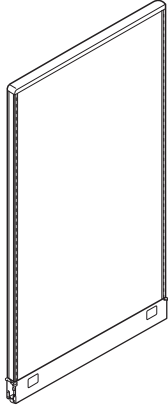

EDP-B (3-circuit)
EDP-2 (4-circuit, 2+2)
EDP-4 (4-circuit, 3+1)



Features

- Includes powered panel assembly, radius steel top cap, with or without one-piece base raceway cover, 1.6 hinge kits, side trim rails, leveling glides and carpet gripper; power distribution assembly/flex connector(s). .6 base raceway end caps are shipped with each panel. Order additional as necessary.
- Panel surfaces may have same laminate on both sides or a different laminate on each side.
- Panel thickness is 2"(51mm).
- Base raceway is 4"(102mm) high.
- Powered raceway with or without raceway cover requires modified catalog number and list price.
- Powered panels are available for countries that utilize 120 volt 60 hertz electrical systems and U.S. configured plugs and outlets.
- Shipped with unassembled top cap, base raceway cover and side trim rails.

Specification Tips

- Panels will accept add-on panels up to a combined height of 82"(2083mm). For aesthetic consistency, specify UniGroup add-on panels.
- Flex connectors provided for powered monolithic panels accommodate straight in-line, inside 90°, and inside 120° conditions (if applicable).
- Receptacles for powered panels must be specified separately.
- Raceway cover must be separately specified for optional -BE, BYE, 2E, 2YE, 4E or 4YE (no raceway cover).
- Additional base raceway cover end caps will need to be specified if finish posts are not ordered.

To Order, Specify:

1) Product number, including:

1 3-Circuit

- B** With Raceway Cover
- BE** Without Raceway Cover, deduct **\$135.06** list
- BY** NYC with Raceway Cover, add **\$80.16** list
- BYE** NYC without Raceway Cover, deduct **\$54.90** list

4-Circuit, 2+2

- 2** With Raceway Cover, add **\$45.07** list
- 2E** Without Raceway Cover, deduct **\$89.99** list
- 2Y** NYC with Raceway Cover, add **\$125.23** list
- 2YE** NYC without Raceway Cover, deduct **\$9.83** list

4-Circuit, 3+1

- 4** With Raceway Cover, add **\$45.07** list
- 4E** Without Raceway Cover, deduct **\$89.99** list
- 4Y** NYC with Raceway Cover, add **\$125.23** list
- 4YE** NYC without Raceway Cover, deduct **\$9.83** list

- 2) Laminate surface color for panel side one.
- 3) Laminate surface color for panel side two.
- 4) Trim color for raceway cover, glide housings and end caps.
- 5) Trim color for top cap and side trim rails.

Note: Upcharge for mixed surface grades, refer to the electronic design and specification tools for pricing.

NOTES:

- Powered panels with raceway covers ship with receptacle ports in the base raceway cover. Receptacle ports on the raceway cover measure 2.35"(60mm) top-to-bottom and 2.88"(73mm) side-to-side.
- Powered panels with Power Distribution Assembly (PDA) but without raceway covers require separately specified base raceway covers for power and communication port locations other than the standard powered base raceway cover.
- New York City (NYC) electrical applications require metal installation of PDA.
- New York Port Authority (NYPA) electrical applications require metal raceway covers. To order, specify NYC powered panels without raceway cover and separately specify metal covers through Haworth eParts.
- Some building codes may restrict the use of panel heights greater than 69"(1753mm). Consult your local code authority to assure that the furniture layout is compliant.
- For International Power, specify non-powered panels and use Power Logic components. See Specification Guide for more information on Power Logic.
- For Chicago power, specify non-powered panels without a base raceway cover and separately specify Chicago power retrofit kit.



Laminate Monolithic Panel with Steel Top Cap — Powered

UniGroup

Laminate	Actual Height	Width	Number ①	Laminate			
				A	B		
37"(940mm)	12"(305mm)	12"(305mm)	EDP-135- [] []	\$1919.94	\$1976.94		
		18"(457mm)	EDP-1835- [] []	2098.89	2168.91		
		24"(610mm)	EDP-235- [] []	2262.45	2345.49		
		30"(762mm)	EDP-3035- [] []	2426.01	2522.07		
		36"(914mm)	EDP-335- [] []	2589.57	2698.65		
		42"(1067mm)	EDP-4235- [] []	2753.13	2875.23		
		48"(1219mm)	EDP-435- [] []	2916.69	3051.81		
		60"(1524mm)	EDP-535- [] []	3243.81	3404.97		
		44"(1118mm)	12"(305mm)	EDP-142- [] []	\$2065.96	\$2134.44	
				18"(457mm)	EDP-1842- [] []	2244.91	2326.41
				24"(610mm)	EDP-242- [] []	2408.47	2502.99
				30"(762mm)	EDP-3042- [] []	2572.03	2679.57
36"(914mm)	EDP-342- [] []			2735.59	2856.15		
42"(1067mm)	EDP-424- [] []			2899.15	3032.73		
48"(1219mm)	12"(305mm)	EDP-442- [] []	3062.71	3209.31			
		18"(457mm)	EDP-542- [] []	3389.83	3562.47		
		24"(610mm)	EDP-542- [] []	\$2191.12	\$2269.44		
		30"(762mm)	EDP-248- [] []	2370.07	2461.41		
		36"(914mm)	EDP-248- [] []	2533.63	2637.99		
		42"(1067mm)	EDP-3048- [] []	2697.19	2814.57		
50"(1270mm)	12"(305mm)	EDP-348- [] []	2860.75	2991.15			
		18"(457mm)	EDP-4248- [] []	3024.31	3167.73		
		24"(610mm)	EDP-448- [] []	3187.87	3344.31		
		30"(762mm)	EDP-548- [] []	3514.99	3697.47		
		36"(914mm)	EDP-154- [] []	\$2316.28	\$2404.44		
		42"(1067mm)	EDP-1854- [] []	2495.23	2596.41		
56"(1422mm)	12"(305mm)	EDP-254- [] []	2658.79	2772.99			
		18"(457mm)	EDP-3054- [] []	2822.35	2949.57		
		24"(610mm)	EDP-354- [] []	2985.91	3126.15		
		30"(762mm)	EDP-4254- [] []	3149.47	3302.73		
		36"(914mm)	EDP-454- [] []	3313.03	3479.31		
		42"(1067mm)	EDP-554- [] []	3640.15	3832.47		
64"(1625mm)	12"(305mm)	EDP-162- [] []	\$2483.16	\$2584.44			
		18"(457mm)	EDP-1862- [] []	2662.11	2776.41		
		24"(610mm)	EDP-262- [] []	2825.67	2952.99		
		30"(762mm)	EDP-3062- [] []	2989.23	3129.57		
		36"(914mm)	EDP-362- [] []	3152.79	3306.15		
		42"(1067mm)	EDP-4262- [] []	3316.35	3482.73		
68"(1727mm)	12"(305mm)	EDP-462- [] []	3479.91	3659.31			
		18"(457mm)	EDP-562- [] []	3807.03	4012.47		
		24"(610mm)	EDP-166- [] []	\$2566.60	\$2674.44		
		30"(762mm)	EDP-1866- [] []	2745.55	2866.41		
		36"(914mm)	EDP-266- [] []	2909.11	3042.99		
		42"(1067mm)	EDP-3066- [] []	3072.67	3219.57		
82"(2083mm)	12"(305mm)	EDP-366- [] []	3236.23	3396.15			
		18"(457mm)	EDP-4266- [] []	3399.79	3572.73		
		24"(610mm)	EDP-466- [] []	3563.35	3749.31		
		30"(762mm)	EDP-566- [] []	3890.47	4102.47		
		36"(914mm)	EDP-180- [] []	\$2914.78	\$3045.58		
		42"(1067mm)	EDP-1880- [] []	3218.89	3362.71		
82"(2083mm)	12"(305mm)	EDP-280- [] []	3507.61	3664.45			
		18"(457mm)	EDP-3080- [] []	3796.33	3966.19		
		24"(610mm)	EDP-380- [] []	4085.05	4267.93		
		30"(762mm)	EDP-4280- [] []	4373.77	4569.67		
		36"(914mm)	EDP-480- [] []	4662.49	4871.41		
		42"(1067mm)	EDP-580- [] []	5239.93	5474.89		

OBSOLETE! April 2024

Open Frame Panel with Steel Top Cap — No Power

UniGroup

Open-Frame

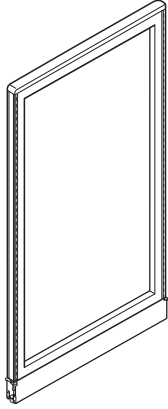

EON-B (Non-Powered)

Features

- Includes non-powered panel assembly, radius steel top cap, with or without one-piece base raceway cover, 1.6 hinge kits, side trim rails, leveling glides and carpet gripper. **6** base raceway end caps are shipped with each panel. Order additional as necessary.
- Panel thickness is 2”(51mm).
- Base raceway is 4”(102mm) high.
- Does not accept top feed modules.
- Shipped with unassembled top cap, base raceway cover and side trim rails.

Specification Tips

- Panels will accept glazed add-on panels up to a combined height of 82”(2083mm). For aesthetic consistency, specify UniGroup add-on panels.
- Raceway cover must be separately specified for option -BE (no raceway cover).
- Additional base raceway cover end caps will need to be specified if finish posts are not ordered.

To Order, Specify:

- 1) Product number, including:

① Options:

B With Raceway Cover

BE Without Raceway Cover, deduct **\$152.49** list

- 2) Trim color for raceway cover, glide housings and end caps.
- 3) Trim color for frame, top cap and side trim rails.







































































Note: Upcharge for mixed surface grades, refer to the electronic design and specification tools for pricing.

NOTES:

- *Non-powered panels ship without receptacle ports in the base raceway cover.*
- *Some building codes may restrict the use of panel heights greater than 69”(1753mm). Consult your local code authority to assure that the furniture layout is compliant.*
- *For International Power, specify non-powered panels and use Power Logic components. See Specification Guide for more information on Power Logic.*
- *For Chicago power, specify non-powered panels without a base raceway cover and separately specify Chicago power retrofit kit.*

Open Frame Panel with Steel Top Cap — No Power

UniGroup

	Actual Height	Width	Number ^①	Price
Open Frame	37"(940mm)	12"(305mm)	EON-135-  	\$ 856.00
		18"(457mm)	EON-1835-  	919.62
		24"(610mm)	EON-235-  	983.24
		36"(914mm)	EON-335-  	1110.48
		42"(1067mm)	EON-4235-  	1174.10
		48"(1219mm)	EON-435-  	1237.72
	44"(1118mm)	60"(1524mm)	EON-535-  	1364.96
		12"(305mm)	EON-142-  	\$ 946.90
		18"(457mm)	EON-1842-  	1028.73
		24"(610mm)	EON-242-  	1110.56
		36"(914mm)	EON-342-  	1274.22
		42"(1067mm)	EON-4242-  	1356.05
	64"(1626mm)	48"(1219mm)	EON-442-  	1437.88
		60"(1524mm)	EON-542-  	1601.54
		12"(305mm)	EON-162-  	\$1315.95
		18"(457mm)	EON-1862-  	1455.93
		24"(610mm)	EON-262-  	1595.91
		36"(914mm)	EON-362-  	1875.87
	68"(1727mm)	42"(1067mm)	EON-4262-  	2015.85
		48"(1219mm)	EON-462-  	2155.83
		60"(1524mm)	EON-562-  	2435.79
		12"(305mm)	EON-166-  	\$1386.82
		18"(457mm)	EON-1866-  	1544.98
		24"(610mm)	EON-266-  	1703.14
82"(2083mm)	36"(914mm)	EON-366-  	2019.46	
	42"(1067mm)	EON-4266-  	2177.62	
	48"(1219mm)	EON-466-  	2335.78	
	60"(1524mm)	EON-566-  	2652.10	
	12"(305mm)	EON-180-  	\$1552.27	
	18"(457mm)	EON-1880-  	1728.62	
	24"(610mm)	EON-280-  	1904.97	
	36"(914mm)	EON-380-  	2257.67	
	42"(1067mm)	EON-4280-  	2434.02	
	48"(1219mm)	EON-480-  	2610.37	
	60"(1524mm)	EON-580-  	2963.07	

Open Frame Panel with Steel Top Cap — Powered

UniGroup

Open-Frame

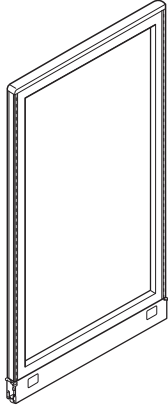

EOP-B (3-circuit)
EOP-2 (4-circuit, 2+2)
EOP-4 (4-circuit, 3+1)



Features

- Includes powered panel assembly, radius steel top cap, with or without one-piece base raceway cover, 1.6 hinge kits, side trim rails, leveling glides and carpet gripper; power distribution assembly/flex connector(s). .6 base raceway end caps are shipped with each panel. Order additional as necessary.
- Panel thickness is 2"(51mm).
- Base raceway is 4"(102mm) high.
- Powered raceway with or without raceway cover requires modified catalog number and list price.
- Powered panels are available for countries that utilize 120 volt 60 hertz electrical systems and U.S. configured plugs and outlets.
- Does not accept top feed modules.
- Shipped with unassembled top cap, base raceway cover and side trim rails.

Specification Tips

- Panels will accept glazed add-on panels up to a combined height of 82"(2083mm). For aesthetic consistency, specify UniGroup add-on panels.
- Flex connectors provided for powered monolithic panels accommodate straight in-line, inside 90°, and inside 120° conditions (if applicable).
- Receptacles for powered panels must be specified separately.
- Raceway cover must be separately specified for option -BE, BYE, 2E, 2YE, 4E or 4YE (no raceway cover).
- Additional base raceway cover end caps will need to be specified if finish posts are not ordered.

To Order, Specify:

1) Product number, including:

① 3-Circuit

- B** With Raceway Cover
- BE** Without Raceway Cover, deduct **\$167.90** list
- BY** NYC with Raceway Cover
- BYE** NYC without Raceway Cover, deduct **\$167.90** list

4-Circuit, 2+2

- 2** With Raceway Cover
- 2E** Without Raceway Cover, deduct **\$167.90** list
- 2Y** NYC with Raceway Cover
- 2YE** NYC without Raceway Cover, deduct **\$167.90** list

4-Circuit, 3+1

- 4** With Raceway Cover
- 4E** Without Raceway Cover, deduct **\$167.90** list
- 4Y** NYC with Raceway Cover
- 4YE** NYC without Raceway Cover, deduct **\$167.90** list

2) Trim color for raceway cover, glide housings and end caps.

3) Trim color for frame, top cap and side trim rails.

Note: Upcharge for mixed surface grades, refer to the electronic design and specification tools for pricing.

NOTES:

- Powered panels with raceway covers ship with receptacle ports in the base raceway cover. Receptacle ports on the raceway cover measure 2.35"(60mm) top-to-bottom and 2.88"(73mm) side-to-side.
- Powered panels with Power Distribution Assemblies (PDA) but without raceway covers require separately specified base raceway covers for power and communication port locations other than the standard powered base raceway cover.
- New York City (NYC) electrical applications require field installation of PDA.
- New York Port Authority (NYPA) electrical applications require metal raceway covers. To order, specify NYC powered panels without raceway cover and separately specify metal covers through Haworth eParts.
- Some building codes may restrict the use of panel heights greater than 69"(1753mm). Consult your local code authority to assure that the furniture layout is compliant.
- For International Power, specify non-powered panels and use Power Logic components. See Specification Guide for more information on Power Logic.
- For Chicago power, specify non-powered panels without a base raceway cover and separately specify Chicago power retrofit kit.

Open Frame Panel with Steel Top Cap — Powered

UniGroup

	Actual Height	Width	Number ^①	Price
Open Frame	37"(940mm)	12"(305mm)	EOP-135-■ ■	\$1273.94
		18"(457mm)	EOP-1835-■ ■	1352.97
		24"(610mm)	EOP-235-■ ■	1416.59
		36"(914mm)	EOP-335-■ ■	1543.83
		42"(1067mm)	EOP-4235-■ ■	1607.45
		48"(1219mm)	EOP-435-■ ■	1671.07
	44"(1118mm)	60"(1524mm)	EOP-535-■ ■	1798.31
		12"(305mm)	EOP-142-■ ■	\$1364.84
		18"(457mm)	EOP-1842-■ ■	1462.08
		24"(610mm)	EOP-242-■ ■	1543.91
		36"(914mm)	EOP-342-■ ■	1707.57
		42"(1067mm)	EOP-4242-■ ■	1789.40
	64"(1626mm)	48"(1219mm)	EOP-442-■ ■	1871.23
		60"(1524mm)	EOP-542-■ ■	2034.89
		12"(305mm)	EOP-162-■ ■	\$1733.89
		18"(457mm)	EOP-1862-■ ■	1889.28
		24"(610mm)	EOP-262-■ ■	2029.26
		36"(914mm)	EOP-362-■ ■	2309.22
	68"(1727mm)	42"(1067mm)	EOP-4262-■ ■	2449.20
		48"(1219mm)	EOP-462-■ ■	2589.18
		60"(1524mm)	EOP-562-■ ■	2869.14
		12"(305mm)	EOP-166-■ ■	\$1804.76
		18"(457mm)	EOP-1866-■ ■	1978.33
		24"(610mm)	EOP-266-■ ■	2136.49
82"(2083mm)	36"(914mm)	EOP-366-■ ■	2452.81	
	42"(1067mm)	EOP-4266-■ ■	2610.97	
	48"(1219mm)	EOP-466-■ ■	2769.13	
	60"(1524mm)	EOP-566-■ ■	3085.45	
	12"(305mm)	EOP-180-■ ■	\$1970.21	
	18"(457mm)	EOP-1880-■ ■	2161.97	
	24"(610mm)	EOP-280-■ ■	2338.32	
	36"(914mm)	EOP-380-■ ■	2691.02	
	42"(1067mm)	EOP-4280-■ ■	2867.37	
	48"(1219mm)	EOP-480-■ ■	3043.72	
	60"(1524mm)	EOP-580-■ ■	3396.42	

Glazed Monolithic Panel with Steel Top Cap — No Power

UniGroup

Glazed

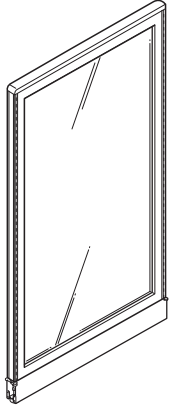

EGN-B (Non-Powered)

Features

- Includes non-powered panel assembly, radius steel top cap, with or without one-piece base raceway cover, 1.6 hinge kits, side trim rails, leveling glides and carpet gripper. **.6** base raceway end caps are shipped with each panel. Order additional as necessary.
- Panel thickness is 2”(51mm).
- Base raceway is 4”(102mm) high.
- Does not accept top feed modules.
- Shipped with unassembled top cap, base raceway cover and side trim rails.

Specification Tips

- Panels will accept glazed add-on panels up to a combined height of 82”(2083mm). For aesthetic consistency, specify UniGroup add-on panels.
- Raceway cover must be separately specified for option -BE (no raceway cover).
- Additional base raceway cover end caps will need to be specified if finish post are not ordered.

To Order, Specify:

- 1) Product number, including:

① Options:

- B** With Raceway Cover
- BE** Without Raceway Cover, deduct **\$152.49** list

- 2) Glazing finish color.
- 3) Trim color for raceway cover, glide housings and end caps.
- 4) Trim color for frame, top cap and side trim rails.

Note: Upcharge for mixed surface grades, refer to the electronic design and specification tools for pricing.

NOTES:

- *Non-powered panels ship without receptacle ports in the base raceway cover.*
- *Some building codes may restrict the use of panel heights greater than 69”(1753mm). Consult your local code authority to assure that the furniture layout is compliant.*
- *For International Power, specify non-powered panels and use Power Logic components. See Specification Guide for more information on Power Logic.*
- *For Chicago power, specify non-powered panels without a base raceway cover and separately specify Chicago power retrofit kit.*

Glazed Monolithic Panel with Steel Top Cap — No Power

UniGroup

	Actual Height	Width	Number ①	Clear	Frosted
Glazed	44"(1118mm)	12"(305mm)	EGN-142- ■ ■	\$2010.49	\$2865.54
		18"(457mm)	EGN-1842- ■ ■	2256.99	3280.20
		24"(610mm)	EGN-242- ■ ■	2503.49	3694.86
		30"(762mm)	EGN-3042- ■ ■	2749.99	4109.52
		36"(914mm)	EGN-342- ■ ■	2996.49	4524.18
		42"(1067mm)	EGN-4242- ■ ■	3242.99	4938.84
		48"(1219mm)	EGN-442- ■ ■	3489.49	5353.50
		60"(1524mm)	EGN-542- ■ ■	3982.49	6182.82
	56"(1422mm)	12"(305mm)	EGN-154- ■ ■	\$2034.13	\$2866.33
		18"(457mm)	EGN-1854- ■ ■	2321.72	3336.24
		24"(610mm)	EGN-254- ■ ■	2609.31	3806.15
		30"(762mm)	EGN-3054- ■ ■	2896.90	4276.06
		36"(914mm)	EGN-354- ■ ■	3184.49	4745.97
		42"(1067mm)	EGN-4254- ■ ■	3472.08	5215.88
		48"(1219mm)	EGN-454- ■ ■	3759.67	5685.79
		60"(1524mm)	EGN-554- ■ ■	4334.85	6625.61
	64"(1626mm)	12"(305mm)	EGN-162- ■ ■	\$2057.74	\$3053.50
		18"(457mm)	EGN-1862- ■ ■	2345.33	3523.41
		24"(610mm)	EGN-262- ■ ■	2345.33	3523.41
		30"(762mm)	EGN-3062- ■ ■	2345.33	3523.41
		36"(914mm)	EGN-362- ■ ■	2345.33	3523.41
		42"(1067mm)	EGN-4262- ■ ■	2345.33	3523.41
		48"(1219mm)	EGN-462- ■ ■	2345.33	3523.41
		60"(1524mm)	EGN-562- ■ ■	2345.33	3523.41
68"(1727mm)	12"(305mm)	EGN-166- ■ ■	\$2180.99	\$3219.38	
	18"(457mm)	EGN-1866- ■ ■	2468.58	3689.29	
	24"(610mm)	EGN-266- ■ ■	2756.17	4159.20	
	30"(762mm)	EGN-3066- ■ ■	3043.76	4629.11	
	36"(914mm)	EGN-366- ■ ■	3331.35	5099.02	
	42"(1067mm)	EGN-4266- ■ ■	3618.94	5568.93	
	48"(1219mm)	EGN-466- ■ ■	3906.53	6038.84	
	60"(1524mm)	EGN-566- ■ ■	4481.71	6978.66	
82"(2083mm)	12"(305mm)	EGN-180- ■ ■	\$2493.25	\$3639.53	
	18"(457mm)	EGN-1880- ■ ■	2900.00	4186.82	
	24"(610mm)	EGN-280- ■ ■	3306.75	4734.11	
	30"(762mm)	EGN-3080- ■ ■	3713.50	5281.40	
	36"(914mm)	EGN-380- ■ ■	4120.25	5828.69	
	42"(1067mm)	EGN-4280- ■ ■	4527.00	6375.98	
	48"(1219mm)	EGN-480- ■ ■	4933.75	6923.27	
	60"(1524mm)	EGN-580- ■ ■	5747.25	8017.85	

Glazed Monolithic Panel with Steel Top Cap — Powered

UniGroup

Glazed

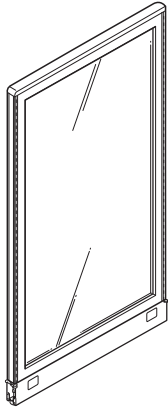

EGP-B (3-circuit)
EGP-2 (4-circuit, 2+2)
EGP-4 (4-circuit, 3+1)



Features

- Includes powered panel assembly, radius steel top cap, with or without one-piece base raceway cover, 1.6 hinge kits, side trim rails, leveling glides and carpet gripper; power distribution assembly/flex connector(s). .6 base raceway end caps are shipped with each panel. Order additional as necessary.
- Panel thickness is 2"(51mm).
- Base raceway is 4"(102mm) high.
- Powered raceway with or without raceway cover requires modified catalog number and list price.
- Powered panels are available for countries that utilize 120 volt 60 hertz electrical systems and U.S. configured plugs and outlets.
- Does not accept top feed modules.
- Shipped with unassembled top cap, base raceway cover and side trim rails.

Specification Tips

- Panels will accept glazed add-on panels up to a combined height of 82"(2083mm). For aesthetic consistency, specify UniGroup add-on panels.
- Flex connectors provided for powered monolithic panels accommodate straight in-line, inside 90°, and inside 120° conditions (if applicable).
- Receptacles for powered panels must be specified separately.
- Raceway cover must be separately specified for option -BE, BYE, 2E, 2YE, 4E or 4YE (no raceway cover).
- Additional base raceway cover end caps will need to be specified if finish post are not ordered.

To Order, Specify:

1) Product number, including:

① 3-Circuit

- B** With Raceway Cover
- BE** Without Raceway Cover, deduct **\$167.90** list
- BY** NYC with Raceway Cover
- BYE** NYC without Raceway Cover, deduct **\$167.90** list

4-Circuit, 2+2

- 2** With Raceway Cover
- 2E** Without Raceway Cover, deduct **\$167.90** list
- 2Y** NYC with Raceway Cover
- 2YE** NYC without Raceway Cover, deduct **\$167.90** list

4-Circuit, 3+1

- 4** With Raceway Cover
- 4E** Without Raceway Cover, deduct **\$167.90** list
- 4Y** NYC with Raceway Cover
- 4YE** NYC without Raceway Cover, deduct **\$167.90** list

2) Glazing finish color.

3) Trim color for raceway cover, glide housings and end caps.

4) Trim color for frame, top cap and side trim rails.

Note: Upcharge for mixed surface grades, refer to the electronic design and specification tools for pricing.

NOTES:

- Powered panels with raceway covers ship with receptacle ports in the base raceway cover. Receptacle ports on the raceway cover measure 2.35"(60mm) top-to-bottom and 2.88"(73mm) side-to-side.
- Powered panels with Power Distribution Assemblies (PDA) but without raceway covers require separately specified base raceway covers for power and communication port locations other than the standard powered base raceway cover.
- New York City (NYC) electrical applications require field installation of PDA.
- New York Port Authority (NYPA) electrical applications require metal raceway covers. To order, specify NYC powered panels without raceway cover and separately specify metal covers through Haworth eParts.
- Some building codes may restrict the use of panel heights greater than 69"(1753mm). Consult your local code authority to assure that the furniture layout is compliant.
- For International Power, specify non-powered panels and use Power Logic components. See Specification Guide for more information on Power Logic.
- For Chicago power, specify non-powered panels without a base raceway cover and separately specify Chicago power retrofit kit.

Glazed Monolithic Panel with Steel Top Cap — Powered

UniGroup

	Actual Height	Width	Number ①	Clear	Frosted	
Glazed	44"(1118mm)	12"(305mm)	EGP-142-	\$2428.43	\$3283.48	
		18"(457mm)	EGP-1842-	2690.34	3713.55	
		24"(610mm)	EGP-242-	2936.84	4128.21	
		30"(762mm)	EGP-3042-	3183.34	4542.87	
		36"(914mm)	EGP-342-	3429.84	4957.53	
		42"(1067mm)	EGP-4242-	3676.34	5372.19	
		48"(1219mm)	EGP-442-	3922.84	5786.85	
		60"(1524mm)	EGP-542-	4415.84	6616.17	
		56"(1422mm)	12"(305mm)	EGP-154-	\$2452.07	\$3284.27
			18"(457mm)	EGP-1854-	2755.07	3769.59
			24"(610mm)	EGP-254-	3042.66	4239.50
			30"(762mm)	EGP-3054-	3330.25	4709.41
			36"(914mm)	EGP-354-	3617.84	5179.32
			42"(1067mm)	EGP-4254-	3905.43	5649.23
			48"(1219mm)	EGP-454-	4193.02	6119.14
			60"(1524mm)	EGP-554-	4768.20	7058.96
		64"(1626mm)	12"(305mm)	EGP-162-	\$2475.68	\$3471.44
			18"(457mm)	EGP-1862-	2778.68	3956.76
			24"(610mm)	EGP-262-	2778.68	3956.76
			30"(762mm)	EGP-3062-	2778.68	3956.76
			36"(914mm)	EGP-362-	2778.68	3956.76
			42"(1067mm)	EGP-4262-	2778.68	3956.76
			48"(1219mm)	EGP-462-	2778.68	3956.76
			60"(1524mm)	EGP-562-	2778.68	3956.76
	68"(1727mm)	12"(305mm)	EGP-166-	\$2598.93	\$3637.32	
		18"(457mm)	EGP-1866-	2901.93	4122.64	
		24"(610mm)	EGP-266-	3189.52	4592.55	
		30"(762mm)	EGP-3066-	3477.11	5062.46	
		36"(914mm)	EGP-366-	3764.70	5532.37	
		42"(1067mm)	EGP-4266-	4052.29	6002.28	
		48"(1219mm)	EGP-466-	4339.88	6472.19	
		60"(1524mm)	EGP-566-	4915.06	7412.01	
	82"(2083mm)	12"(305mm)	EGP-180-	\$2911.19	\$4057.47	
		18"(457mm)	EGP-1880-	3333.35	4620.17	
		24"(610mm)	EGP-280-	3740.10	5167.46	
		30"(762mm)	EGP-3080-	4146.85	5714.75	
		36"(914mm)	EGP-380-	4553.60	6262.04	
		42"(1067mm)	EGP-4280-	4960.35	6809.33	
		48"(1219mm)	EGP-480-	5367.10	7356.62	
		60"(1524mm)	EGP-580-	6180.60	8451.20	

Fabric Add-On Panel

UniGroup

Fabric

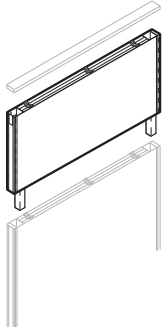

NOTE:

This panel has fabric/colorway restrictions, see *Fabrics/Color Legend*.

Features

- Includes panel, vertical connector (bayonet), light block, side trim rails, two full hinge sets, one side trim rail cover and top cap clips.
- Fabric add-on panels may be installed above any straight fabric and laminate base or fabric add-on panels.
- Both sides in same fabric; one color or different color each side.
- Each base panel will accept two add-on panels.
- Lower Level add-on panel will accept overhead components (load bearing). Second add-on panel (top) is non-load bearing.
- Utilizes top cap from base panel.
- Standard finish posts can be used.
- Same construction as UniGroup Monolithic fabric panel.

Specification Tips

- For mixed fabric surfaces, specify fabric/color for each fabric surface and price at higher grade.
- Add-on panels may be stacked a maximum of two high in any order of height above a base panel.
- Add-on panel must match panel width.
- Combination of panel and add-on panel cannot exceed 82" (2083mm) in height.
- Cannot be used above any door, glazed, legacy videne, open-frame or glazed add-on panels.
- Base and add-on panel combinations should match existing base panel heights so that end-of-runs and finish posts can be used without field modification.
- Full-height side trim rails required for end-of-run conditions with a base panel and one add-on panel, separately specified.
- For two high add-on panel applications specify separately full-height side trim rail for base panel and one high add on, for two high panel add on location use side trim rail that ships with add-on panel.
- Clerestory can be added above fabric add-on panels. See Specification Guide for application guidelines.

To Order, Specify:

- 1) Product number.
- 2) Fabric/colorway for add-on panel side one.
- 3) Fabric/colorway for add-on panel side two.
- 4) Trim color for side trim rails, and trim strip.

Fabric Add-On Panel

UniGroup

Fabric	Actual Height	Width	Number	Fabric Grade					
				A	B	C	E	F	G
12"(305mm)	12"(305mm)	EAF-112	\$1026.07	\$1066.95	\$1074.31	\$1089.19	\$1096.61	\$1104.03	
	18"(457mm)	EAF-1812	1078.05	1126.79	1142.83	1176.69	1196.75	1212.09	
	24"(610mm)	EAF-212	1130.03	1186.63	1211.35	1264.19	1296.89	1320.15	
	30"(762mm)	EAF-3012	1182.01	1246.47	1279.87	1351.69	1397.03	1428.21	
	36"(914mm)	EAF-312	1233.99	1306.31	1348.39	1439.19	1497.17	1536.27	
	42"(1067mm)	EAF-4212	1285.97	1366.15	1416.91	1526.69	1597.31	1644.33	
	48"(1219mm)	EAF-412	1337.95	1425.99	1485.43	1614.19	1697.45	1752.39	
	54"(1372mm)	EAF-5412	1389.93	1485.83	1553.95	1701.69	1797.59	1860.45	
	60"(1524mm)	EAF-512	1441.91	1545.67	1622.47	1789.19	1897.73	1968.51	
14"(356mm)	12"(305mm)	EAF-114	\$1076.21	\$1124.69	\$1140.41	\$1173.63	\$1193.21	\$1208.27	
	18"(457mm)	EAF-1814	1128.19	1184.53	1208.93	1261.13	1293.35	1316.33	
	24"(610mm)	EAF-214	1180.17	1244.37	1277.45	1348.63	1393.49	1424.39	
	30"(762mm)	EAF-3014	1232.15	1304.21	1345.97	1436.13	1493.63	1532.45	
	36"(914mm)	EAF-314	1284.13	1364.05	1414.49	1523.63	1593.77	1640.51	
	42"(1067mm)	EAF-4214	1336.11	1423.89	1483.01	1611.13	1693.91	1748.57	
	48"(1219mm)	EAF-414	1388.09	1483.73	1551.53	1698.63	1794.05	1856.63	
	54"(1372mm)	EAF-5414	1440.07	1543.57	1620.05	1786.13	1894.19	1964.69	
	60"(1524mm)	EAF-514	1492.05	1603.41	1688.57	1873.63	1994.33	2072.75	
18"(437mm)	12"(305mm)	EAF-118	\$1176.49	\$1240.17	\$1272.61	\$1342.51	\$1386.41	\$1416.75	
	18"(457mm)	EAF-1818	1228.47	1300.01	1341.13	1430.01	1486.55	1524.81	
	24"(610mm)	EAF-218	1280.45	1359.85	1409.65	1517.51	1586.69	1632.87	
	30"(762mm)	EAF-3018	1332.43	1419.69	1478.17	1605.01	1686.83	1740.93	
	36"(914mm)	EAF-318	1384.41	1479.53	1546.69	1692.51	1786.97	1848.99	
	42"(1067mm)	EAF-4218	1436.39	1539.37	1615.21	1780.01	1887.11	1957.05	
	48"(1219mm)	EAF-418	1488.37	1599.21	1683.73	1867.51	1987.25	2065.11	
	54"(1372mm)	EAF-5418	1540.35	1659.05	1752.25	1955.01	2087.39	2173.17	
	60"(1524mm)	EAF-518	1592.33	1718.89	1820.77	2042.51	2187.53	2281.23	
20"(437mm)	12"(305mm)	EAF-120	\$1226.63	\$1297.91	\$1338.71	\$1426.95	\$1483.01	\$1520.99	
	18"(457mm)	EAF-1820	1278.61	1357.75	1407.23	1514.45	1583.15	1629.05	
	24"(610mm)	EAF-220	1330.59	1417.59	1475.75	1601.95	1683.29	1737.11	
	30"(762mm)	EAF-3020	1382.57	1477.43	1544.27	1689.45	1783.43	1845.17	
	36"(914mm)	EAF-320	1434.55	1537.27	1612.79	1776.95	1883.57	1953.23	
	42"(1067mm)	EAF-4220	1486.53	1597.11	1681.31	1864.45	1983.71	2061.29	
	48"(1219mm)	EAF-420	1538.51	1656.95	1749.83	1951.95	2083.85	2169.35	
	54"(1372mm)	EAF-5420	1590.49	1716.79	1818.35	2039.45	2183.99	2277.41	
	60"(1524mm)	EAF-520	1642.47	1776.63	1886.87	2126.95	2284.13	2385.47	
24"(610mm)	12"(305mm)	EAF-124	\$1326.91	\$1413.39	\$1470.91	\$1595.83	\$1676.21	\$1729.47	
	18"(457mm)	EAF-1824	1378.89	1473.23	1539.43	1683.33	1776.35	1837.53	
	24"(610mm)	EAF-224	1430.87	1533.07	1607.95	1770.83	1876.49	1945.59	
	30"(762mm)	EAF-3024	1482.85	1592.91	1676.47	1858.33	1976.63	2053.65	
	36"(914mm)	EAF-324	1534.83	1652.75	1744.99	1945.83	2076.77	2161.71	
	42"(1067mm)	EAF-4224	1586.81	1712.59	1813.51	2033.33	2176.91	2269.77	
	48"(1219mm)	EAF-424	1638.79	1772.43	1882.03	2120.83	2277.05	2377.83	
	54"(1372mm)	EAF-5424	1690.77	1832.27	1950.55	2208.33	2377.19	2485.89	
	60"(1524mm)	EAF-524	1742.75	1892.11	2019.07	2295.83	2477.33	2593.95	

Glazed Add-On Panel

UniGroup

Glazed

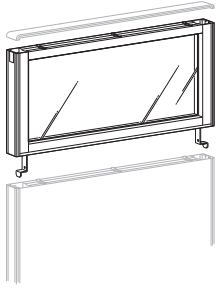

EAG

NOTE:

*Add-on panel cannot be used with add-on panels ordered with the SP** prefix.

Features

- Includes panel, vertical connector (bayonet), light block, side trim rails, two full hinge sets, one side trim rail cover, and top cap clips.
- Utilizes top cap from base panel.
- Glazed add-on panels may be installed above any straight fabric, glazed, laminate, or open-frame base or add-on panels.*
- Each base panel will accept two add-on panels.
- Glazed add-on panels will not accept any load bearing components.
- Top rail of add-on panel will provide top wire management.
- Textured glazing material is textured on one side only. Recommend installing the textured side to face the interior of the workstation.
- Standard finish post and end-of-run posts can be used.

Specification Tips

- Specify glazed add-on panel based upon the type of panel, fabric (F)/laminate (L) or glazed/open-frame (G), that will be directly below the add-on panel.
- Add-on panels may be stacked a maximum of two high in any order of height above a base panel.
- Add-on panel must match base panel width.
- Combination of base panel and add-on panel cannot exceed 82"(2083mm) in height.
- Base and add-on panel combinations should match existing base panel heights so that end-of-runs and finish posts can be used without field modification.
- Cannot be used above doors, or legacy videne panels.
- Does not accept top feed modules.
- To convert a glazed add-on above a fabric/laminate monolithic base panel to a glazed add-on above a glazed base panel or (vice versa), a vertical connector (bayonet) retrofit kit is available. Order separately through Haworth eParts.
- Full-height side trim rails required for end-of-run conditions with a base panel and one add-on panel, separately specified.
- For two high add-on panel applications specify separately full-height side trim rail for base panel and one high add on, for two high panel add on location use side trim rail that ships with add-on panel.
- Clerestory can be added above glazed add-on panels. See Specification Guide for application guidelines.
- **Patterned Glass (SQ-CM Checks Mix, SQ-ER English Reeded and SQ-VM Vertical Moire) available on 12"(305mm) and 18"(457mm) high add-on panels only.**

To Order, Specify:

- 1) Product number, including:













































① Application Designation

- F** Glazed add-on panel directly above fabric/laminate base panel or fabric add-on panel.
- G** Glazed add-on panel directly above glazed and open frame base panel or glazed add-on panel, add **\$56.34** list.

- 2) Glazing color or glass pattern.
- 3) Trim color for frame, side trim rails and trim strip.

Glazed Add-On Panel

UniGroup

	Actual Height	Width	Number ①	Glass Grade A	C*	D*
Glazed	12"(305mm)	12"(305mm)	EAG-112- 	\$1064.39	\$1296.31	\$1356.95
		18"(457mm)	EAG-1812- 	1150.16	1414.60	1475.24
		24"(610mm)	EAG-212- 	1235.93	1532.89	1593.53
		30"(762mm)	EAG-3012- 	1321.70	1651.18	1711.82
		36"(914mm)	EAG-312- 	1407.47	1769.47	1830.11
		42"(1067mm)	EAG-4212- 	1493.24	1887.76	1948.40
		48"(1219mm)	EAG-412- 	1579.01	2006.05	2066.69
		54"(1372mm)	EAG-5412- 	1664.78	2124.34	2184.98
		60"(1524mm)	EAG-512- 	1750.55	2242.63	2303.27
	14"(356mm)	12"(305mm)	EAG-114- 	\$1116.19	N/A	\$1483.14
		18"(457mm)	EAG-1814- 	1201.96	N/A	1601.43
		24"(610mm)	EAG-214- 	1287.73	N/A	1719.72
		30"(762mm)	EAG-3014- 	1373.50	N/A	1838.01
		36"(914mm)	EAG-314- 	1459.27	N/A	1956.30
		42"(1067mm)	EAG-4214- 	1545.04	N/A	2074.59
		48"(1219mm)	EAG-414- 	1630.81	N/A	2192.88
		54"(1372mm)	EAG-5414- 	1716.58	N/A	2311.17
		60"(1524mm)	EAG-514- 	1802.35	N/A	2429.46
	18"(457mm)	12"(305mm)	EAG-118- 	\$1219.79	\$1497.28	\$1735.52
		18"(457mm)	EAG-1818- 	1305.56	1615.57	1853.81
		24"(610mm)	EAG-218- 	1391.33	1733.86	1972.10
		30"(762mm)	EAG-3018- 	1477.10	1852.15	2090.39
		36"(914mm)	EAG-318- 	1562.87	1970.44	2208.68
		42"(1067mm)	EAG-4218- 	1648.64	2088.73	2326.97
		48"(1219mm)	EAG-418- 	1734.41	2207.02	2445.26
		54"(1372mm)	EAG-5418- 	1820.18	2325.31	2563.55
		60"(1524mm)	EAG-518- 	1905.95	2443.60	2681.84
	20"(508mm)	12"(305mm)	EAG-120- 	\$1271.59	N/A	\$1861.71
		18"(457mm)	EAG-1820- 	1357.36	N/A	1980.00
		24"(610mm)	EAG-220- 	1443.13	N/A	2098.29
		30"(762mm)	EAG-3020- 	1528.90	N/A	2216.58
		36"(914mm)	EAG-320- 	1614.67	N/A	2334.87
		42"(1067mm)	EAG-4220- 	1700.44	N/A	2453.16
		48"(1219mm)	EAG-420- 	1786.21	N/A	2571.45
		54"(1372mm)	EAG-5420- 	1871.98	N/A	2689.74
		60"(1524mm)	EAG-520- 	1957.75	N/A	2808.03
	24"(610mm)	12"(305mm)	EAG-124- 	\$1375.19	N/A	\$2114.09
		18"(457mm)	EAG-1824- 	1460.96	N/A	2232.38
		24"(610mm)	EAG-224- 	1546.73	N/A	2350.67
		30"(762mm)	EAG-3024- 	1632.50	N/A	2468.96
		36"(914mm)	EAG-324- 	1718.27	N/A	2587.25
		42"(1067mm)	EAG-4224- 	1804.04	N/A	2705.54
		48"(1219mm)	EAG-424- 	1889.81	N/A	2823.83
		54"(1372mm)	EAG-5424- 	1975.58	N/A	2942.12
		60"(1524mm)	EAG-524- 	2061.35	N/A	3060.41

*Patterned Glass (SQ-CM Checks Mix, SQ-ER English Reeded and SQ-VM Vertical Moire) available on 12"(305mm) and 18"(457mm) high add-on panels only.

Swing Doors with Steel Top Cap

UniGroup

	Actual Height	Width	Door Swing	Number	Laminate A	B
Single Door — Laminate	82"(2083mm)	36"(914mm)	Left	EDS-380-BHL	\$4990.66	\$5309.62
		42"(1067mm)	Left	EDS-4280-BHL	5242.41	5581.52

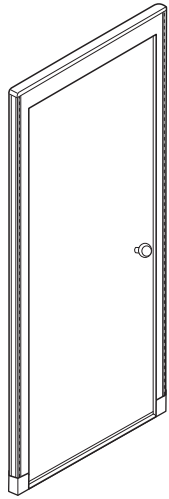

EDS-BKL
EDS-BHL



(Left-hand swing)

Features

- Includes complete panel assembly [hinge sets, carpet gripper, door jamb, side trim rails, leveling glides and trim, hollow core door (1.625"(41mm) thick), door hinges, hardware, ADA lever with lockset and keys, and threshold].
- Both sides of door covered in same laminate surface color.
- Doors are shipped left-hand swing. Field-adjustable for right-hand swing.
- No power or communications in base raceway.

Specification Tips

- Door may be placed a maximum of 24"(610mm) from supporting panels at 90°.
- Will not accept add-on panel.

Door Opening Clearance

Door Size	Height	Width
380	78"(1981mm)	28.75"(730mm)
4280	78"(1981mm)	34.75"(883mm)

To Order, Specify:

- 1) Product number.
- 2) Laminate surface color.
- 3) Trim color for raceway covers and glide housings.
- 4) Trim color for door jamb, top cap and side trim rails.

NOTES:

Some building codes may restrict the use of panel heights greater than 69"(1753mm). Consult your local code authority to assure that the furniture layout is compliant prior to installation.

Most building codes for new buildings require a minimum clear door width of 32"(813mm). To meet this requirement, the 42"(1067mm) door must be ordered.

Single Door with ADA Lever and Kick Plate — Laminate

	Actual Height	Width	Door Swing	Hardware	Number	Laminate A	B
	82"(2083mm)	42"(1067mm)	Left	Lever	EAC-4280-BHL	\$7016.69	\$7355.80

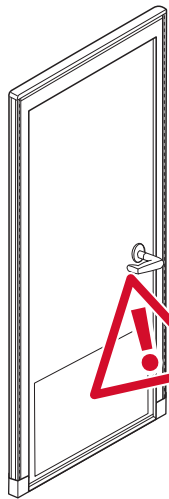

EAC-4280-BHL



(Left-hand swing)

Features

- Includes complete panel assembly [hinge sets, carpet gripper, door jamb, door (1.44"(37mm) thick), door hinges, brushed chrome lever with lockset and keys, threshold, and brushed chrome kick plate with mounting screws].
- Both sides of door covered in same laminate surface color.
- Doors are shipped left-hand swing. Field-adjustable for right-hand swing.
- No power or communications in base raceway.

Specification Tips

- Door may be placed a maximum of 24"(610mm) from supporting panels at 90°.
- Will not accept add-on panel.

Door Opening Clearance

Door Size	Height	Width
4280	78"(1981mm)	34.75"(883mm)

To Order, Specify:

- 1) Product number.
- 2) Laminate surface color.
- 3) Trim color for raceway covers and glide housings.
- 4) Trim color for door jamb, top cap and side trim rails.

NOTES:

Some building codes may restrict the use of panel heights greater than 69"(1753mm). Consult your local code authority to assure that the furniture layout is compliant prior to installation.

Most building codes for new buildings require a minimum clear door width of 32"(813mm). To meet this requirement, the 42"(1067mm) door must be ordered.

OBSOLETE! March 2024

Swing Doors with Steel Top Cap

UniGroup

	Actual Height	Width	Number ¹ ²	Clear Laminate A	Laminate B	Finish Laminate A	Laminate B
Single Door — Glazed	82"(2083mm)	36"(914mm)	EDG-380-B	\$5698.41	\$6120.56	\$6392.09	\$6814.24
		42"(1067mm)	EDG-4280-B	6180.60	6641	680.86	7341.57

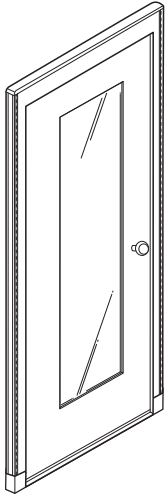

EDG-BKL
EDG-BHL

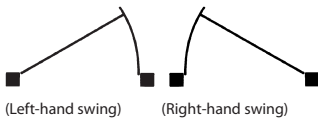

Features

- Includes complete panel assembly [hinge sets, carpet gripper, door jamb, side trim rails and trim, door (1.625"(41mm) thick with 0.25"(6mm) glazing), door hinges, hardware, brushed chrome knobs or ADA lever with lockset and keys, and threshold].
- Both sides of door covered in same laminate surface color.
- **Door swing not field changeable.**
- No power or communications in base raceway.

Specification Tips

- Door may be placed a maximum of 24"(610mm) from side wall to panels at 90°.
- Will not accept add-on panel.

Door Opening Clearance

Door Size	Height	Width
380	78"(1981mm)	20.5"(730mm)
4280	78"(1981mm)	34.75"(883mm)

To Order, Specify:

1) Product number, including:

1 Hardware Designation

- K** Knob
- H** ADA Lever, add \$319.54 list.

2 Door Swing

- L** Left
- R** Right

- 2) Glazing finish color.
- 3) Laminate surface color.
- 4) Trim color for raceway covers and glide housings.
- 5) Trim color for door jamb, top cap and side trim rails.

NOTES:

Some building codes may restrict the use of panel heights greater than 69"(1753mm). Consult your local code authority to assure that the furniture layout is compliant prior to installation.

Most building codes for new buildings require a minimum clear door width of 32"(813mm). To meet this requirement, the 42"(1067mm) door must be ordered.



OBSOLETE

March 2024

Panel Accessories

UniGroup

	Actual Height	Width	Number	Price
90° Finish Post — for Steel Top Cap — Painted Surface	30"(762mm)	2"(51mm)	FPPC-28-B	\$157.07
	37"(940mm)		FPPC-35-B	166.17
	44"(1118mm)		FPPC-42-B	175.27
	50"(1270mm)		FPPC-48-B	183.07
	56"(1422mm)		FPPC-54-B	190.87
	64"(1626mm)		FPPC-62-B	201.27
	68"(1727mm)		FPPC-66-B	206.47
	82"(2083mm)		FPPC-80-B	224.67

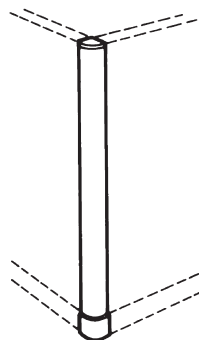

FPPC-B

Features

- Includes 90° painted vertical cover, radius plastic top cap and base raceway cover.
- Required by UL for covering base raceway flexible and straight-span power connectors when power connector covers are not used.

To Order, Specify:

- 1) Product number.
- 2) Paint surface color.
- 3) Trim color for raceway cover.
- 4) Trim color for top cap.

90° Power Connector Cover	4"(102mm)		PCC-90-B	\$118.35
----------------------------------	-----------	--	----------	-----------------

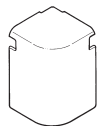

PCC-90-B

Features

- Includes six power connector covers.
- Required by UL for covering flexible power connector in 90° panel configurations when a finish post is not used.

To Order, Specify:

- 1) Product number.
- 2) Trim color.

Specification Tip

- For use with UniGroup and PLACES panels.

180° Power Connector Cover — Radius Profile	4"(102mm)		PCC-180-B	\$118.35
--	-----------	--	-----------	-----------------



PCC-180-B

Features

- Includes six power connector covers.
- Required by UL for covering straight-span or flexible power connectors in 180°, three-way panel configurations when a finish post is not used.

To Order, Specify:

- 1) Product number.
- 2) Trim color.

Specification Tip

- For use with UniGroup Too, UniGroup and PLACES panels.

180° Finish Post — for Steel Top Cap — Painted Surface	30"(762mm)	2"(51mm)	FPPS-28-B	\$134.32
	37"(940mm)		FPPS-35-B	143.28
	44"(1118mm)		FPPS-42-B	152.24
	50"(1270mm)		FPPS-48-B	159.92
	56"(1422mm)		FPPS-54-B	167.60
	64"(1626mm)		FPPS-62-B	177.84
	68"(1727mm)		FPPS-66-B	182.96
	82"(2083mm)		FPPS-80-B	200.88

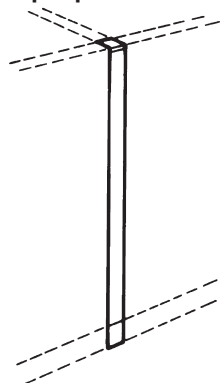

FPPS-B

Features

- Includes 180° painted vertical cover, radius plastic top cap and base raceway cover.
- Required by UL for covering base raceway flexible and straight-span power connectors when power connector covers are not used.

To Order, Specify:

- 1) Product number.
- 2) Paint surface color.
- 3) Trim color for raceway cover.
- 4) Trim color for top cap.

Steel Top Cap for 3-Way and 4-Way	Height	Depth	Width	Number	Price
	0.75"(19mm)	2"(51mm)	2"(51mm)	FPC-2	\$46.33



FPC-2

Features

- Includes one plastic top cap.
- Fills gap at intersection of four UniGroup radius steel top cap panels.

To Order, Specify:

- 1) Product number.
- 2) Trim color.

Panel Accessories

UniGroup

	Height	Base Panel Height/ Add-On Panel	Number	Trim A	B
Full-Height Side Trim Rails — for use with Add-On Panels	44"(1118mm)	30"(762mm)/14"(356mm)	SREH-2814	\$154.73	\$189.51
	50"(1270mm)	30"(762mm)/20"(508mm)	SREH-2820	161.03	207.39
	56"(1422mm)	44"(1118mm)/12"(305mm)	SREH-4212	167.33	225.27
	64"(1626mm)	44"(1118mm)/20"(508mm)	SREH-4220	175.73	249.11
	68"(1727mm)	44"(1118mm)/24"(610mm)	SREH-4224	179.93	261.03
	64"(1626mm)	50"(1270mm)/14"(356mm)	SREH-4814	175.73	249.11
	68"(1727mm)	50"(1270mm)/18"(457mm)	SREH-4818	179.93	261.03
	68"(1727mm)	56"(1422mm)/12"(305mm)	SREH-5412	179.93	261.03
	82"(2083mm)	64"(1626mm)/18"(457mm)	SREH-6218	194.63	302.75
	82"(2083mm)	68"(1727mm)/14"(356mm)	SREH-6614	194.63	302.75



SREH

Feature

- Includes one full height side trim rail.

Specification Tips

- For use with base panel and one add-on panel.
- For two high add-on panel applications specify separately full-height side trim rail for base panel and one high add-on, for two high panel location use side trim rail that ships with add-on panel. See Specification Guide for application guidelines.

To Order, Specify:

- 1) Product number.
- 2) Trim color.

Side Trim Rail

SRE

Panel Height	Number	Trim A	B
30"(762mm)	SRE-28	\$116.94	\$124.70
37"(940mm)	SRE-35	124.29	145.56
44"(1118mm)	SRE-42	131.64	166.42
50"(1270mm)	SRE-48	137.94	184.30
56"(1422mm)	SRE-54	144.24	202.18
64"(1626mm)	SRE-62	152.64	226.02
68"(1727mm)	SRE-66	156.84	237.94
82"(2083mm)	SRE-80	171.54	279.66

Features

- Includes one side trim rail.
- Specify two side trim rails for each condition.
- Two side trim rails are included with each panel.
- Order as replacement only.
- For UniGroup panels only.

To Order, Specify:

- 1) Product number.
- 2) Trim color.

Hinges

HE

Panel Height	Hinge Width	Number	Price
30"(762mm)	1.125"(29mm)	HE-28	\$20.50
37"(940mm)		HE-35	21.48
44"(1118mm)		HE-42	21.97
50"(1270mm)		HE-48	22.46
56"(1422mm)		HE-54	22.95
64"(1626mm)		HE-62	23.44
68"(1727mm)		HE-66	23.93
82"(2083mm)		HE-80	24.91

Features

- Includes one hinge set for one side of trim rail.
- For replacement only (hinges are included with panels).
- One hinge set connects every two panels for angular connections.
- Two hinges set are used for straight-line conditions.

To Order, Specify:

- 1) Product number.
- 2) Trim color.

Panel Accessories

UniGroup

	Height	Depth	Width	Number	Trim A	B
Wall Track	60"(1524mm)	0.75"(19mm)	0.625"(16mm)	WT-60	\$233.74	\$245.38
	72"(1829mm)			WT-72	274.42	286.06
	84"(213mm)			WT-84	315.10	326.74

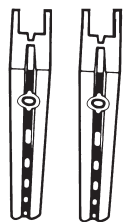

WT

Features

- Includes two wall tracks and attachment screws (#10 2.5"(64mm) long).
- For attachment of components to structural walls.
- See installation instructions for proper mounting.

To Order, Specify:

- 1) Product number.
- 2) Trim color for track.

Specification Tip

- Not for use with up-mount overhead storage unit.

Wall Mount Kit



WMK

Panel Height	Number	Trim A	B
30"(762mm)	WMK-30	\$110.99	\$114.90
37"(940mm)	WMK-35	130.54	134.45
44"(1118mm)	WMK-42	157.91	161.82
50"(1270mm)	WMK-48	185.28	189.19
56"(1422mm)	WMK-54	204.83	208.74
64"(1626mm)	WMK-62	236.11	240.02
68"(1727mm)	WMK-66	255.66	259.57
82"(2083mm)	WMK-80	306.49	310.40

Features

- Includes wall-mount channel, hinges and screws.
- For mounting panels, with or without add-on panel, to a structural wall.
- Adds 0.25"(6mm) to the panel width.

To Order, Specify:

- 1) Product number.
- 2) Trim color.

Specification Tip

- Must be properly anchored to a structural wall.

T-Mount Kit — Center and End Conditions

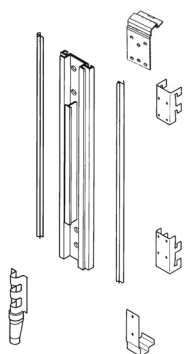

TMKT-B

Panel Height	Number	Price
30"(762mm)	TMKT-28-B	\$179.26
37"(940mm)	TMKT-35-B	193.36
44"(1118mm)	TMKT-42-B	231.53
50"(1270mm)	TMKT-48-B	253.51
56"(1422mm)	TMKT-54-B	273.62
64"(1626mm)	TMKT-62-B	317.93
68"(1727mm)	TMKT-66-B	334.07
82"(2083mm)	TMKT-80-B	372.32

Features

- Includes pre-drilled side rail, center-mount brackets, end-mount brackets, light block extrusions, glide housing, and screws.
- Brackets included for both center- and end-mount T-conditions.
- Connects two panels in a T-condition. T-mount can attach to a base panel and one fabric add-on panel. Configuration coming off of a T-mount cannot contain add-on panels.

To Order, Specify:



- 1) Product number.
- 2) Trim color.

Specification Tips

- Both panels in a T-mount condition must be of equal height.
- Cannot mount on glazed panels, glazed add-on panels or doors.
- For use with UniGroup panels.

Panel Accessories

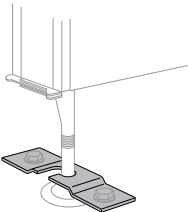
UniGroup

	Actual Height	Depth	Width	Number	Price
All-Purpose Hook  CH-8 Class AA	1"(25mm)	3"(76mm)	0.625"(16mm)	CH-8	\$181.26
Features <ul style="list-style-type: none"> Includes eight hooks. Attaches to panel steel top cap. For use with UniGroup panels only. 		To Order, Specify: <ol style="list-style-type: none"> Product number. Trim color. 			
<hr/>					
Seismic Anchoring Bracket  HAB Class BA				HAB-0001	\$333.05
Features <ul style="list-style-type: none"> Includes package of six formed steel brackets. For seismic anchoring of UniGroup Too, UniGroup and PLACES panels. 		To Order, Specify: <ol style="list-style-type: none"> Product number. (No finish specification required.) 			
<hr/>					
Friction Pad  7031-0501 Class BA				7031-0501	\$18.94
Feature <ul style="list-style-type: none"> Includes one pad. 		To Order, Specify: <ol style="list-style-type: none"> Product number. (No finish specification required.) 			
Specification Tip <ul style="list-style-type: none"> Attaches to bottom of glide to prevent movement of panels on hard surface flooring. 					

Monolithic Fabric Panel with Steel Top Cap — No Power

PLACES

Fabric

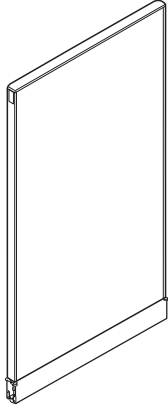

HFN (Non-Powered)

Features

- Includes non-powered or powered panel assembly, low profile top cap, with or without one-piece base raceway cover, 1.6 hinge kits, side trim rails, leveling glides and carpet gripper; power distribution assembly/flex connector(s) when power is specified. .6 base raceway end caps are shipped with each panel. Order additional as necessary.
- Acoustical panel surfaces.
- Panel surfaces may have the same fabric on both sides or a different fabric on each side.
- Panel thickness is 2"(51mm).
- Base raceway is 4"(102mm) high.
- Powered raceway with or without raceway cover requires modified catalog number and list price.
- Powered panels are available for countries that utilize 120 volt 60 hertz electrical systems and U.S. configured plugs and outlets.
- Shipped with unassembled top cap, base raceway cover and side trim rails.

Specification Tips

- Panels will accept add-on panels up to a combined height of 82"(2083mm). For aesthetic consistency, specify PLACES add-on panels.
- Flex connectors provided for powered monolithic panels accommodate straight in-line, inside 90°, and inside 120° conditions (if applicable).
- Receptacles for powered panels must be specified separately.
- Raceway cover must be separately specified for option -E (no raceway cover).
- Additional base raceway end caps will need to be specified if finish post are not ordered.

To Order, Specify:

- 1) Product number, including:

① Option:

- E** Without Raceway Cover, deduct **\$175.26** list (No option required for Raceway Cover)

- 2) Fabric/colorway for panel side one.
- 3) Fabric/colorway for panel side two.
- 4) Trim color for raceway cover, glide housings and end caps.
- 5) Trim color for top cap and side trim rails.

Note: For mixed grade surfaces pricing will be determined by the sum of the upcharges. Please refer to the electronic catalog.

NOTES:

- Powered panels with raceway covers ship with receptacle ports in the base raceway cover. Receptacle ports on the raceway cover measure 2.35"(60mm) top-to-bottom and 2.88"(73mm) side-to-side.
- Non-powered panels ship without receptacle ports in the base raceway cover.
- Powered panels with Power Distribution Assemblies (PDA) but without raceway covers require separately specified base raceway covers for power and communication port locations other than the standard powered base raceway cover.
- New York City (NYC) electrical applications require field installation of PDA.
- New York Port Authority (NYPA) electrical applications require metal raceway covers. To order, specify NYC powered panels without raceway cover and separately specify metal covers through Haworth e-Parts.
- Some building codes may restrict the use of panel heights greater than 69"(1753mm). Consult your local code authority to assure that the furniture layout is compliant.
- For International Power, specify non-powered panels and use Power Logic components. See Specification Guide for more information on Power Logic.
- For Chicago power, specify non-powered panels without a base raceway cover and separately specify Chicago power retrofit kit.

Monolithic Fabric Panel with Steel Top Cap — No Power

PLACES

	Actual Height	Width	Number ①	Fabric Grade					
				A	B	C	E	F	G
zFabric	30"(762mm)	12"(305mm)	HFN-1230-	\$1428.58	\$1458.56	\$1464.90	\$1475.64	\$1480.98	\$1491.08
		18"(457mm)	HFN-1830-	1587.58	1607.14	1629.94	1678.54	1712.14	1731.58
		24"(610mm)	HFN-2430-	1746.58	1785.70	1831.30	1928.50	1995.70	2034.58
		30"(762mm)	HFN-3030-	1905.58	1964.26	2032.66	2178.46	2279.26	2337.58
		36"(914mm)	HFN-3630-	2064.58	2142.82	2234.02	2428.42	2562.82	2640.58
		42"(1067mm)	HFN-4230-	2223.58	2321.38	2435.38	2678.38	2846.38	2943.58
		48"(1219mm)	HFN-4830-	2382.58	2499.94	2636.74	2928.34	3129.94	3246.58
		54"(1372mm)	HFN-5430-	2541.58	2678.50	2838.10	3178.30	3413.50	3549.58
		60"(1524mm)	HFN-6030-	2700.58	2857.06	3039.46	3428.26	3697.06	3852.58
		37"(940mm)	12"(305mm)	HFN-1237-	\$1491.80	\$1501.42	\$1510.20	\$1534.82	\$1550.76
	18"(457mm)		HFN-1837-	1664.48	1695.22	1728.24	1803.02	1855.68	1884.72
		24"(610mm)	HFN-2437-	1837.16	1889.02	1946.28	2160.22	2160.60	2209.32
		30"(762mm)	HFN-3037-	2009.84	2082.82	2164.32	2339.42	2465.52	2533.92
		36"(914mm)	HFN-3637-	2182.52	2276.62	2382.36	2607.62	2770.44	2858.52
		42"(1067mm)	HFN-4237-	2355.20	2470.42	2600.40	2875.82	3075.36	3183.12
		48"(1219mm)	HFN-4837-	2527.88	2664.22	2818.44	3144.02	3380.28	3507.72
		54"(1372mm)	HFN-5437-	2700.56	2858.02	3036.48	3412.22	3685.20	3832.32
		60"(1524mm)	HFN-6037-	2873.24	3051.82	3254.52	3680.42	3990.12	4156.92
		44"(1118mm)	12"(305mm)	HFN-1244-	\$1552.52	\$1571.04	\$1592.26	\$1636.78	\$1667.84
	18"(457mm)		HFN-1844-	1725.38	1760.70	1806.28	1899.28	1963.82	2002.10
		24"(610mm)	HFN-2444-	1898.24	1950.36	2020.30	2161.78	2259.80	2317.64
		30"(762mm)	HFN-3044-	2071.10	2140.02	2234.32	2424.28	2555.78	2633.18
		36"(914mm)	HFN-3644-	2243.96	2329.68	2448.34	2686.78	2851.76	2948.72
		42"(1067mm)	HFN-4244-	2416.82	2519.34	2662.36	2949.28	3147.74	3264.26
		48"(1219mm)	HFN-4844-	2589.68	2709.00	2876.38	3211.78	3443.72	3579.80
		54"(1372mm)	HFN-5444-	2762.54	2898.66	3090.40	3474.28	3739.70	3895.34
	60"(1524mm)	HFN-6044-	2935.40	3088.32	3304.42	3736.78	4035.68	4210.88	
	50"(1270mm)	12"(305mm)	HFN-1250-	\$1598.06	\$1623.40	\$1652.32	\$1714.42	\$1754.86	\$1780.14
18"(457mm)		HFN-1850-	1776.20	1824.46	1878.58	1994.20	2072.80	2120.76	
	24"(610mm)	HFN-2450-	1954.34	2025.52	2104.84	2273.98	2390.74	2461.38	
	30"(762mm)	HFN-3050-	2132.48	2226.58	2331.10	2553.76	2708.68	2802.00	
	36"(914mm)	HFN-3650-	2310.62	2427.64	2557.36	2833.54	3026.62	3142.62	
	42"(1067mm)	HFN-4250-	2488.76	2628.70	2783.62	3113.32	3344.56	3483.24	
	48"(1219mm)	HFN-4850-	2666.90	2829.76	3009.88	3393.10	3662.50	3823.86	
	54"(1372mm)	HFN-5450-	2845.04	3030.82	3236.14	3672.88	3980.44	4164.48	
	60"(1524mm)	HFN-6050-	3023.18	3231.88	3462.40	3952.66	4298.38	4505.10	
	56"(1422mm)	12"(305mm)	HFN-1256-	\$1643.64	\$1676.58	\$1712.38	\$1790.32	\$1843.46	\$1876.30
18"(457mm)		HFN-1856-	1831.92	1887.78	1950.94	2085.16	2177.42	2233.18	
	24"(610mm)	HFN-2456-	2020.20	2098.98	2189.50	2380.00	2511.38	2590.06	
	30"(762mm)	HFN-3056-	2208.48	2310.18	2428.06	2674.84	2845.34	2946.94	
	36"(914mm)	HFN-3656-	2396.76	2521.38	2666.62	2969.68	3179.30	3303.82	
	42"(1067mm)	HFN-4256-	2585.04	2732.58	2905.18	3264.52	3513.26	3660.70	
	48"(1219mm)	HFN-4856-	2773.32	2943.78	3143.74	3559.36	3847.22	4017.58	
	54"(1372mm)	HFN-5456-	2961.60	3154.98	3382.30	3854.20	4181.18	4374.46	
	60"(1524mm)	HFN-6056-	3149.88	3366.18	3620.86	4149.04	4515.14	4731.34	
	64"(1626mm)	12"(305mm)	HFN-1264-	\$1686.56	\$1724.54	\$1769.28	\$1861.18	\$1926.86	\$1964.78
18"(457mm)		HFN-1864-	1884.08	1947.86	2019.84	2172.58	2279.06	2342.66	
	24"(610mm)	HFN-2464-	2081.60	2171.18	2270.40	2483.98	2631.26	2720.54	
	30"(762mm)	HFN-3064-	2279.12	2394.50	2520.96	2795.38	2983.46	3098.42	
	36"(914mm)	HFN-3664-	2476.64	2617.82	2771.52	3106.78	3335.66	3476.30	
	42"(1067mm)	HFN-4264-	2674.16	2841.14	3022.08	3418.18	3687.86	3854.18	
	48"(1219mm)	HFN-4864-	2871.68	3064.46	3272.64	3729.58	4040.06	4232.06	
	54"(1372mm)	HFN-5464-	3069.20	3287.78	3523.20	4040.98	4392.26	4609.94	
	60"(1524mm)	HFN-6064-	3266.72	3511.10	3773.76	4352.38	4744.46	4987.82	
	68"(1727mm)	12"(305mm)	HFN-1268-	\$1724.54	\$1851.06	\$1913.48	\$2045.86	\$2136.84	\$2192.54
18"(457mm)		HFN-1868-	1942.58	2096.58	2187.80	2385.34	2520.00	2601.74	
	24"(610mm)	HFN-2468-	2160.62	2342.10	2462.12	2724.82	2903.16	3010.94	
	30"(762mm)	HFN-3068-	2378.66	2587.62	2736.44	3064.30	3286.32	3420.14	
	36"(914mm)	HFN-3668-	2596.70	2833.14	3010.76	3403.78	3669.48	3829.34	
	42"(1067mm)	HFN-4268-	2814.74	3078.66	3285.08	3743.26	4052.64	4238.54	
	48"(1219mm)	HFN-4868-	3032.78	3324.18	3559.40	4082.74	4435.80	4647.74	
	54"(1372mm)	HFN-5468-	3250.82	3569.70	3833.72	4422.22	4818.96	5056.94	
	60"(1524mm)	HFN-6068-	3468.86	3815.22	4108.04	4761.70	5202.12	5466.14	
	82"(2083mm)	12"(305mm)	HFN-1282-	\$2020.56	\$2111.60	\$2212.80	\$2422.74	\$2571.98	\$2660.52
18"(457mm)		HFN-1882-	2329.14	2455.22	2597.46	2890.68	3099.32	3222.66	
	24"(610mm)	HFN-2482-	2637.72	2798.84	2982.12	3358.62	3626.66	3784.80	
	30"(762mm)	HFN-3082-	2946.30	3142.46	3366.78	3826.56	4154.00	4346.94	
	36"(914mm)	HFN-3682-	3254.88	3486.08	3751.44	4294.50	4681.34	4909.08	
	42"(1067mm)	HFN-4282-	3563.46	3829.70	4136.10	4762.44	5208.68	5471.22	
	48"(1219mm)	HFN-4882-	3872.04	4173.32	4520.76	5230.38	5736.02	6033.36	
	54"(1372mm)	HFN-5482-	4180.62	4516.94	4905.42	5698.32	6263.36	6595.50	
	60"(1524mm)	HFN-6082-	4489.20	4860.56	5290.08	6166.26	6790.70	7157.64	

Monolithic Fabric Panel with Steel Top Cap — Powered

PLACES

Fabric

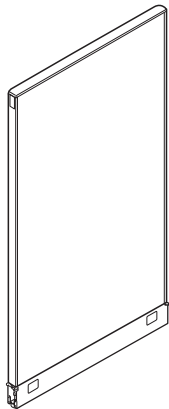

HFP (3-circuit)
HFP-A (4-circuit, 2+2)
HFP-D (4-circuit, 3+1)



Features

- Includes non-powered or powered panel assembly, low profile top cap, with or without one-piece base raceway cover, 1.6 hinge kits, side trim rails, leveling glides and carpet gripper; power distribution assembly/flex connector(s) when power is specified. .6 base raceway end caps are shipped with each panel. Order additional as necessary.
- Acoustical panel surfaces.
- Panel surfaces may have the same fabric on both sides or a different fabric on each side.
- Panel thickness is 2"(51mm).
- Base raceway is 4"(102mm) high.
- Powered raceway with or without raceway cover requires modified catalog number and list price.
- Powered panels are available for countries that utilize 120 volt 60 hertz electrical systems and U.S. configured plugs and outlets.
- Shipped with unassembled top cap, base raceway cover and side trim rails.

Specification Tips

- Panels will accept add-on panels up to a combined height of 82"(2083mm). For aesthetic consistency, specify PLACES add-on panels.
- Flex connectors provided for powered monolithic panels accommodate straight in-line, inside 90°, and inside 120° conditions (if applicable).
- Receptacles for powered panels must be specified separately.
- Raceway cover must be separately specified for option -E, YE, AE, AYE, DE or DYE (no raceway cover).
- Additional base raceway end caps will need to be specified if finish post are not ordered.

To Order, Specify:

1) Product number, including:

① 3-Circuit

- E** Without Raceway Cover, deduct **\$192.98** list
- Y** NYC with Raceway Cover
- YE** NYC without Raceway Cover, deduct **\$192.98** list (No option required with Raceway Cover)

4-Circuit, 2+2

- A** With Raceway Cover
- AE** Without Raceway Cover, deduct **\$192.98** list
- AY** NYC with Raceway Cover
- AYE** NYC without Raceway Cover, deduct **\$192.98** list

4-Circuit, 3+1

- D** With Raceway Cover
- DE** Without Raceway Cover, deduct **\$192.98** list
- DY** NYC with Raceway Cover
- DYE** NYC without Raceway Cover, deduct **\$192.98** list

- 2) Fabric/colorway for panel side one.
- 3) Fabric/colorway for panel side two.
- 4) Trim color for raceway cover, glide housings and end caps.
- 5) Trim color for top cap and side trim rails.

Note: For mixed grade surfaces pricing will be determined by the sum of the upcharges. Please refer to the electronic catalog.

NOTES:

- Powered panels with raceway covers ship with receptacle ports in the base raceway cover. Receptacle ports on the raceway cover measure 2.35"(60mm) top-to-bottom and 2.88"(73mm) side-to-side.
- Non-powered panels ship without receptacle ports in the base raceway cover.
- Powered panels with Power Distribution Assemblies (PDA) but without raceway covers require separately specified base raceway covers for power and communication port locations other than the standard powered base raceway cover.
- New York City (NYC) electrical applications require field installation of PDA.
- New York Port Authority (NYPA) electrical applications require metal raceway covers. To order, specify NYC powered panels without raceway cover and separately specify metal covers through Haworth e-Parts.
- Some building codes may restrict the use of panel heights greater than 69"(1753mm). Consult your local code authority to assure that the furniture layout is compliant.
- For International Power, specify non-powered panels and use Power Logic components. See Specification Guide for more information on Power Logic.
- For Chicago power, specify non-powered panels without a base raceway cover and separately specify Chicago power retrofit kit.

Monolithic Fabric Panel with Steel Top Cap — Powered

PLACES

Fabric	Actual Height	Width	Number ¹	Fabric Grade						
				A	B	C	E	F	G	
30"(762mm)	12"(305mm)		HFP-1230-	\$1908.98	\$1938.96	\$1945.30	\$1956.04	\$1961.38	\$1971.48	
	18"(457mm)		HFP-1830-	2085.70	2105.26	2128.06	2176.66	2210.26	2229.70	
	24"(610mm)		HFP-2430-	2244.70	2283.82	2329.42	2426.62	2493.82	2532.70	
	30"(762mm)		HFP-3030-	2403.70	2462.38	2530.78	2676.58	2777.38	2835.70	
	36"(914mm)		HFP-3630-	2562.70	2640.94	2732.14	2926.54	3060.94	3138.70	
	42"(1067mm)		HFP-4230-	2721.70	2819.50	2933.50	3176.50	3344.50	3441.70	
	48"(1219mm)		HFP-4830-	2880.70	2998.06	3134.86	3426.46	3628.06	3744.70	
	54"(1372mm)		HFP-5430-	3039.70	3176.62	3336.22	3676.42	3911.62	4047.70	
	60"(1524mm)		HFP-6030-	3198.70	3355.18	3537.58	3926.38	4195.18	4350.70	
	37"(940mm)	12"(305mm)		HFP-1237-	\$1972.20	\$1981.82	\$1990.60	\$2015.22	\$2031.16	\$2040.52
		18"(457mm)		HFP-1837-	2162.60	2193.34	2226.36	2301.14	2353.80	2382.84
		24"(610mm)		HFP-2437-	2335.28	2387.14	2444.40	2569.34	2658.72	2707.44
		30"(762mm)		HFP-3037-	2507.96	2580.94	2662.44	2837.54	2963.64	3032.04
36"(914mm)			HFP-3637-	2680.64	2774.74	2880.48	3105.74	3268.56	3356.64	
42"(1067mm)			HFP-4237-	2853.32	2968.54	3098.52	3373.94	3573.48	3681.24	
48"(1219mm)			HFP-4837-	3026.00	3162.34	3316.56	3642.14	3878.40	4005.84	
54"(1372mm)			HFP-5437-	3198.68	3356.14	3534.60	3910.34	4183.32	4330.44	
60"(1524mm)			HFP-6037-	3371.36	3549.94	3752.64	4178.54	4488.24	4655.04	
44"(1118mm)		12"(305mm)		HFP-1244-	\$2032.92	\$2051.44	\$2072.66	\$2117.18	\$2148.24	\$2166.96
		18"(457mm)		HFP-1844-	2223.50	2258.82	2304.40	2397.40	2461.94	2500.22
		24"(610mm)		HFP-2444-	2396.36	2448.48	2518.42	2659.90	2757.92	2815.76
		30"(762mm)		HFP-3044-	2569.22	2638.14	2732.44	2922.40	3053.90	3131.30
	36"(914mm)		HFP-3644-	2974.76	3115.94	3269.64	3604.90	3833.78	3974.42	
	42"(1067mm)		HFP-4244-	2914.94	3017.46	3160.48	3447.40	3645.86	3762.38	
	48"(1219mm)		HFP-4844-	3087.80	3207.12	3374.50	3709.90	3941.84	4077.92	
	54"(1372mm)		HFP-5444-	3260.66	3396.78	3588.52	3972.40	4237.82	4393.46	
	60"(1524mm)		HFP-6044-	3433.52	3586.44	3802.54	4234.90	4533.80	4709.00	
	50"(1270mm)	12"(305mm)		HFP-1250-	\$2078.46	\$2103.80	\$2132.72	\$2194.82	\$2235.26	\$2260.54
		18"(457mm)		HFP-1850-	2274.32	2322.58	2376.70	2492.32	2570.92	2618.88
		24"(610mm)		HFP-2450-	2452.46	2523.64	2602.96	2772.10	2888.86	2959.50
		30"(762mm)		HFP-3050-	2630.60	2724.70	2829.22	3051.88	3206.80	3300.12
36"(914mm)			HFP-3650-	2808.74	2925.76	3055.48	3331.66	3524.74	3640.74	
42"(1067mm)			HFP-4250-	2986.88	3126.82	3281.74	3611.44	3842.68	3981.36	
48"(1219mm)			HFP-4850-	3165.02	3327.88	3508.00	3891.22	4160.62	4321.98	
54"(1372mm)			HFP-5450-	3343.16	3528.94	3734.26	4171.00	4478.56	4662.60	
60"(1524mm)			HFP-6050-	3521.30	3730.00	3960.52	4450.78	4796.50	5003.22	
56"(1422mm)		12"(305mm)		HFP-1256-	\$2124.04	\$2156.98	\$2192.78	\$2270.72	\$2323.86	\$2356.70
		18"(457mm)		HFP-1856-	2330.04	2385.90	2449.06	2583.28	2675.54	2731.30
		24"(610mm)		HFP-2456-	2518.32	2597.10	2687.62	2878.12	3009.50	3088.18
		30"(762mm)		HFP-3056-	2706.60	2808.30	2926.18	3172.96	3343.46	3445.06
	36"(914mm)		HFP-3656-	2894.88	3019.50	3164.74	3467.80	3677.42	3801.94	
	42"(1067mm)		HFP-4256-	3083.16	3230.70	3403.30	3762.64	4011.38	4158.82	
	48"(1219mm)		HFP-4856-	3271.44	3441.90	3641.86	4057.48	4345.34	4515.70	
	54"(1372mm)		HFP-5456-	3459.72	3653.10	3880.42	4352.32	4679.30	4872.58	
	60"(1524mm)		HFP-6056-	3648.00	3864.30	4118.98	4647.16	5013.26	5229.46	
	64"(1626mm)	12"(305mm)		HFP-1264-	\$2166.96	\$2204.94	\$2249.68	\$2341.58	\$2407.26	\$2445.18
		18"(457mm)		HFP-1864-	2382.20	2445.98	2517.96	2670.70	2777.18	2840.78
		24"(610mm)		HFP-2464-	2579.72	2669.30	2768.52	2982.10	3129.38	3218.66
		30"(762mm)		HFP-3064-	2777.24	2892.62	3019.08	3293.50	3481.58	3596.54
36"(914mm)			HFP-3664-	2974.76	3115.94	3269.64	3604.90	3833.78	3974.42	
42"(1067mm)			HFP-4264-	3172.28	3339.26	3520.20	3916.30	4185.98	4352.30	
48"(1219mm)			HFP-4864-	3369.80	3562.58	3770.76	4227.70	4538.18	4730.18	
54"(1372mm)			HFP-5464-	3567.32	3785.90	4021.32	4539.10	4890.38	5108.06	
60"(1524mm)			HFP-6064-	3764.84	4009.22	4271.88	4850.50	5242.58	5485.94	
68"(1727mm)		12"(305mm)		HFP-1268-	\$2204.94	\$2331.46	\$2393.88	\$2526.26	\$2617.24	\$2672.94
		18"(457mm)		HFP-1868-	2440.70	2594.70	2685.92	2883.46	3018.12	3099.86
		24"(610mm)		HFP-2468-	2658.74	2840.22	2960.24	3222.94	3401.28	3509.06
		30"(762mm)		HFP-3068-	2876.78	3085.74	3234.56	3562.42	3784.44	3918.26
	36"(914mm)		HFP-3668-	3094.82	3331.26	3508.88	3901.90	4167.60	4327.46	
	42"(1067mm)		HFP-4268-	3312.86	3576.78	3783.20	4241.38	4550.76	4736.66	
	48"(1219mm)		HFP-4868-	3530.90	3822.30	4057.52	4580.86	4933.92	5145.86	
	54"(1372mm)		HFP-5468-	3748.94	4067.82	4331.84	4920.34	5317.08	5555.06	
	60"(1524mm)		HFP-6068-	3966.98	4313.34	4606.16	5259.82	5700.24	5964.26	
	82"(2083mm)	12"(305mm)		HFP-1282-	\$2500.96	\$2592.00	\$2693.20	\$2903.14	\$3052.38	\$3140.92
		18"(457mm)		HFP-1882-	2827.26	2953.34	3095.58	3388.80	3597.44	3720.78
		24"(610mm)		HFP-2482-	3135.84	3296.96	3480.24	3856.74	4124.78	4282.92
		30"(762mm)		HFP-3082-	3444.42	3640.58	3864.90	4324.68	4652.12	4845.06
36"(914mm)			HFP-3682-	3753.00	3984.20	4249.56	4792.62	5179.46	5407.20	
42"(1067mm)			HFP-4282-	4061.58	4327.82	4634.22	5260.56	5706.80	5969.34	
48"(1219mm)			HFP-4882-	4370.16	4671.44	5018.88	5728.50	6234.14	6531.48	
54"(1372mm)			HFP-5482-	4678.74	5015.06	5403.54	6196.44	6761.48	7093.62	
60"(1524mm)			HFP-6082-	4987.32	5358.68	5788.20	6664.38	7288.82	7655.76	

Basic Monolithic Fabric Panel with Steel Top Cap — No Power

PLACES

Fabric

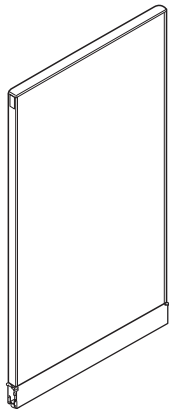

HMN (Non-Powered)

Features

- Includes non-powered or powered panel assembly, low profile top cap, with or without one-piece base raceway cover, 1.6 hinge kits, side trim rails, leveling glides and carpet gripper; power distribution assembly/flex connector(s) when power is specified. .6 base raceway end caps are shipped with each panel. Order additional as necessary.
- Acoustical panel surfaces.
- Panel surfaces may have the same fabric on both sides or a different fabric on each side.
- Panel thickness is 2"(51mm).
- Base raceway is 4"(102mm) high.
- Powered raceway with or without raceway cover requires modified catalog number and list price.
- Powered panels are available for countries that utilize 120 volt 60 hertz electrical systems and U.S. configured plugs and outlets.
- Shipped with unassembled top cap, base raceway cover and side trim rails.

Specification Tips

- Panels will accept add-on panels up to a combined height of 82"(2083mm). For aesthetic consistency, specify PLACES add-on panels.
- Flex connectors provided for powered monolithic panels accommodate straight in-line, inside 90°, and inside 120° conditions (if applicable).
- Receptacles for powered panels must be specified separately.
- Raceway cover must be separately specified for option -E (no raceway cover).
- Additional base raceway end caps will need to be specified if finish post are not ordered.

To Order, Specify:

- 1) Product number, including:

① Option:

- E** Without Raceway Cover, deduct **\$175.26** list (No option required for Raceway Cover)

- 2) Fabric/colorway for panel side one.
- 3) Fabric/colorway for panel side two.
- 4) Trim color for raceway cover, glide housings and end caps.
- 5) Trim color for top cap and side trim rails.

Note: For mixed grade surfaces pricing will be determined by the sum of the upcharges. Please refer to the electronic catalog.

NOTES:

- *Powered panels with raceway covers ship with receptacle ports in the base raceway cover. Receptacle ports on the raceway cover measure 2.35"(60mm) top-to-bottom and 2.88"(73mm) side-to-side.*
- *Non-powered panels ship without receptacle ports in the base raceway cover.*
- *Powered panels with Power Distribution Assemblies (PDA) but without raceway covers require separately specified base raceway covers for power and communication port locations other than the standard powered base raceway cover.*
- *New York City (NYC) electrical applications require field installation of PDA.*
- *New York Port Authority (NYPA) electrical applications require metal raceway covers. To order, specify NYC powered panels without raceway cover and separately specify metal covers through Haworth e-Parts.*
- *Some building codes may restrict the use of panel heights greater than 69"(1753mm). Consult your local code authority to assure that the furniture layout is compliant.*
- *For International Power, specify non-powered panels and use Power Logic components. See Specification Guide for more information on Power Logic.*
- *For Chicago power, specify non-powered panels without a base raceway cover and separately specify Chicago power retrofit kit.*

Basic Monolithic Fabric Panel with Steel Top Cap — No Power

PLACES

	Actual Height	Width	Number ^①	Fabric Grade					
				A	B	C	E	F	G
Fabric Surface — Low Profile Steel Top Cap	30"(762mm)	12"(305mm)	HMN-1230-	\$1180.69	\$1210.67	\$1217.01	\$1227.75	\$1233.09	\$1243.19
	18"(457mm)	HMN-1830-	1314.25	1333.81	1356.61	1405.21	1438.81	1458.25	
	24"(610mm)	HMN-2430-	1447.81	1486.93	1532.53	1629.73	1696.93	1735.81	
	30"(762mm)	HMN-3030-	1581.37	1640.05	1708.45	1854.25	1955.05	2013.37	
	36"(914mm)	HMN-3630-	1714.93	1793.17	1884.37	2078.77	2213.17	2290.93	
	42"(1067mm)	HMN-4230-	1848.49	1946.29	2060.29	2303.29	2471.29	2568.49	
	48"(1219mm)	HMN-4830-	1982.05	2099.41	2236.21	2527.81	2729.41	2846.05	
	54"(1372mm)	HMN-5430-	2115.61	2252.53	2412.13	2752.33	2987.53	3123.61	
	60"(1524mm)	HMN-6030-	2249.17	2405.65	2588.05	2976.85	3245.65	3401.17	
	37"(940mm)	12"(305mm)	HMN-1237-	\$1243.91	\$1253.53	\$1262.31	\$1286.93	\$1302.87	\$1312.23
	18"(457mm)	HMN-1837-	1383.59	1414.33	1447.35	1522.13	1574.79	1603.83	
	24"(610mm)	HMN-2437-	1523.27	1575.13	1632.39	1757.33	1846.71	1895.43	
	30"(762mm)	HMN-3037-	1662.95	1735.93	1817.43	1992.53	2118.63	2187.03	
	36"(914mm)	HMN-3637-	1802.63	1896.73	2002.47	2227.73	2390.55	2478.63	
	42"(1067mm)	HMN-4237-	1942.31	2057.53	2187.51	2462.93	2662.47	2770.23	
	48"(1219mm)	HMN-4837-	2081.99	2218.33	2372.55	2698.13	2934.39	3061.83	
	54"(1372mm)	HMN-5437-	2221.67	2379.13	2557.59	2933.33	3206.31	3353.43	
	60"(1524mm)	HMN-6037-	2361.35	2539.93	2742.63	3168.53	3478.23	3645.03	
	44"(1118mm)	12"(305mm)	HMN-1244-	\$1304.63	\$1323.15	\$1344.37	\$1388.89	\$1419.95	\$1438.67
	18"(457mm)	HMN-1844-	1449.59	1484.91	1530.49	1623.49	1688.03	1726.31	
	24"(610mm)	HMN-2444-	1594.55	1646.67	1716.61	1858.09	1956.11	2013.95	
	30"(762mm)	HMN-3044-	1739.51	1808.43	1902.73	2092.69	2224.19	2301.59	
	36"(914mm)	HMN-3644-	1884.47	1970.19	2088.85	2327.29	2492.27	2589.23	
	42"(1067mm)	HMN-4244-	2029.43	2131.95	2274.97	2561.89	2760.35	2876.87	
	48"(1219mm)	HMN-4844-	2174.39	2293.71	2461.09	2796.49	3028.43	3164.51	
	54"(1372mm)	HMN-5444-	2319.35	2455.47	2647.21	3031.09	3296.51	3452.15	
60"(1524mm)	HMN-6044-	2464.31	2617.23	2833.33	3265.69	3564.59	3739.79		
50"(1270mm)	12"(305mm)	HMN-1250-	\$1350.17	\$1375.51	\$1404.43	\$1466.53	\$1506.97	\$1532.25	
18"(457mm)	HMN-1850-	1500.41	1548.67	1602.79	1718.41	1797.01	1844.97		
24"(610mm)	HMN-2450-	1650.65	1721.83	1801.15	1970.29	2087.05	2157.69		
30"(762mm)	HMN-3050-	1800.89	1894.99	1999.51	2222.17	2377.09	2470.41		
36"(914mm)	HMN-3650-	1951.13	2068.15	2197.87	2474.05	2667.13	2783.13		
42"(1067mm)	HMN-4250-	2101.37	2241.31	2396.23	2725.93	2957.17	3095.85		
48"(1219mm)	HMN-4850-	2251.61	2414.47	2594.59	2977.81	3247.21	3408.57		
54"(1372mm)	HMN-5450-	2401.85	2587.63	2792.95	3229.69	3537.25	3721.29		
60"(1524mm)	HMN-6050-	2552.09	2760.79	2991.31	3481.57	3827.29	4034.01		
56"(1422mm)	12"(305mm)	HMN-1256-	\$1395.75	\$1428.69	\$1464.49	\$1542.43	\$1595.57	\$1628.41	
18"(457mm)	HMN-1856-	1553.55	1609.41	1672.57	1806.79	1899.05	1954.81		
24"(610mm)	HMN-2456-	1711.35	1790.13	1880.65	2071.15	2202.53	2281.21		
30"(762mm)	HMN-3056-	1869.15	1970.85	2088.73	2335.51	2506.01	2607.61		
36"(914mm)	HMN-3656-	2026.95	2151.57	2296.81	2599.87	2809.49	2934.01		
42"(1067mm)	HMN-4256-	2184.75	2332.29	2504.89	2864.23	3112.97	3260.41		
48"(1219mm)	HMN-4856-	2342.55	2513.01	2712.97	3128.59	3416.45	3586.81		
54"(1372mm)	HMN-5456-	2500.35	2693.73	2921.05	3392.95	3719.93	3913.21		
60"(1524mm)	HMN-6056-	2658.15	2874.45	3129.13	3657.31	4023.41	4239.61		
64"(1626mm)	12"(305mm)	HMN-1264-	\$1438.67	\$1476.65	\$1521.39	\$1613.29	\$1678.97	\$1716.89	
18"(457mm)	HMN-1864-	1605.71	1669.49	1741.47	1894.21	2000.69	2064.29		
24"(610mm)	HMN-2464-	1772.75	1862.33	1961.55	2175.13	2322.41	2411.69		
30"(762mm)	HMN-3064-	1939.79	2055.17	2181.63	2456.05	2644.13	2759.09		
36"(914mm)	HMN-3664-	2106.83	2248.01	2401.71	2736.97	2965.85	3106.49		
42"(1067mm)	HMN-4264-	2273.87	2440.85	2621.79	3017.89	3287.57	3453.89		
48"(1219mm)	HMN-4864-	2440.91	2633.69	2841.87	3298.81	3609.29	3801.29		
54"(1372mm)	HMN-5464-	2607.95	2826.53	3061.95	3579.73	3931.01	4148.69		
60"(1524mm)	HMN-6064-	2774.99	3019.37	3282.03	3860.65	4252.73	4496.09		
68"(1727mm)	12"(305mm)	HMN-1268-	\$1476.65	\$1603.17	\$1665.59	\$1797.97	\$1888.95	\$1944.65	
18"(457mm)	HMN-1868-	1654.25	1808.25	1899.47	2097.01	2231.67	2313.41		
24"(610mm)	HMN-2468-	1831.85	2013.33	2133.35	2396.05	2574.39	2682.17		
30"(762mm)	HMN-3068-	2009.45	2218.41	2367.23	2695.09	2917.11	3050.93		
36"(914mm)	HMN-3668-	2187.05	2423.49	2601.11	2994.13	3259.83	3419.69		
42"(1067mm)	HMN-4268-	2364.65	2628.57	2834.99	3293.17	3602.55	3788.45		
48"(1219mm)	HMN-4868-	2542.25	2833.65	3068.87	3592.21	3945.27	4157.21		
54"(1372mm)	HMN-5468-	2719.85	3038.73	3302.75	3891.25	4287.99	4525.97		
60"(1524mm)	HMN-6068-	2897.45	3243.81	3536.63	4190.29	4630.71	4894.73		
82"(2083mm)	12"(305mm)	HMN-1282-	\$1772.67	\$1863.71	\$1964.91	\$2174.85	\$2324.09	\$2412.63	
18"(457mm)	HMN-1882-	2007.87	2133.95	2276.19	2569.41	2778.05	2901.39		
24"(610mm)	HMN-2482-	2243.07	2404.19	2587.47	2963.97	3232.01	3390.15		
30"(762mm)	HMN-3082-	2478.27	2674.43	2898.75	3358.53	3685.97	3878.91		
36"(914mm)	HMN-3682-	2713.47	2944.67	3210.03	3753.09	4139.93	4367.67		
42"(1067mm)	HMN-4282-	2948.67	3214.91	3521.31	4147.65	4593.89	4856.43		
48"(1219mm)	HMN-4882-	3183.87	3485.15	3832.59	4542.21	5047.85	5345.19		
54"(1372mm)	HMN-5482-	3419.07	3755.39	4143.87	4936.77	5501.81	5833.95		
60"(1524mm)	HMN-6082-	3654.27	4025.63	4455.15	5331.33	5955.77	6322.71		

Basic Monolithic Fabric Panel with Steel Top Cap — Powered

PLACES

Fabric

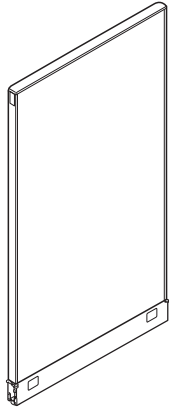

HMP (3-circuit)
HMP-A (4-circuit, 2+2)
HMP-D (4-circuit, 3+1)



Features

- Includes non-powered or powered panel assembly, low profile top cap, with or without one-piece base raceway cover, 1.6 hinge kits, side trim rails, leveling glides and carpet gripper; power distribution assembly/flex connector(s) when power is specified. .6 base raceway end caps are shipped with each panel. Order additional as necessary.
- Acoustical panel surfaces.
- Panel surfaces may have the same fabric on both sides or a different fabric on each side.
- Panel thickness is 2”(51mm).
- Base raceway is 4”(102mm) high.
- Powered raceway with or without raceway cover requires modified catalog number and list price.
- Powered panels are available for countries that utilize 120 volt 60 hertz electrical systems and U.S. configured plugs and outlets.
- Shipped with unassembled top cap, base raceway cover and side trim rails.

Specification Tips

- Panels will accept add-on panels up to a combined height of 82”(2083mm). For aesthetic consistency, specify PLACES add-on panels.
- Flex connectors provided for powered monolithic panels accommodate straight in-line, inside 90°, and inside 120° conditions (if applicable).
- Receptacles for powered panels must be specified separately.
- Raceway cover must be separately specified for option -E, YE, AE, AYE, DE or DYE (no raceway cover).
- Additional base raceway end caps will need to be specified if finish post are not ordered.

To Order, Specify:

1) Product number, including:

① 3-Circuit

- E** Without Raceway Cover, deduct **\$192.98** list
- Y** NYC with Raceway Cover
- YE** NYC without Raceway Cover, deduct **\$192.98** list (No option required with Raceway Cover)

4-Circuit, 2+2

- 2** With Raceway Cover
- 2E** Without Raceway Cover, deduct **\$192.98** list
- 2Y** NYC with Raceway Cover
- 2YE** NYC without Raceway Cover, deduct **\$192.98** list

4-Circuit, 3+1

- 4** With Raceway Cover
- 4E** Without Raceway Cover, deduct **\$192.98** list
- 4Y** NYC with Raceway Cover
- 4YE** NYC without Raceway Cover, deduct **\$192.98** list

- 2) Fabric/colorway for panel side one.
- 3) Fabric/colorway for panel side two.
- 4) Trim color for raceway cover, glide housings and end caps.
- 5) Trim color for top cap and side trim rails.

Note: For mixed grade surfaces pricing will be determined by the sum of the upcharges. Please refer to the electronic catalog.

NOTES:

- Powered panels with raceway covers ship with receptacle ports in the base raceway cover. Receptacle ports on the raceway cover measure 2.35”(60mm) top-to-bottom and 2.88”(73mm) side-to-side.
- Non-powered panels ship without receptacle ports in the base raceway cover.
- Powered panels with Power Distribution Assemblies (PDA) but without raceway covers require separately specified base raceway covers for power and communication port locations other than the standard powered base raceway cover.
- New York City (NYC) electrical applications require field installation of PDA.
- New York Port Authority (NYPA) electrical applications require metal raceway covers. To order, specify NYC powered panels without raceway cover and separately specify metal covers through Haworth e-Parts.
- Some building codes may restrict the use of panel heights greater than 69”(1753mm). Consult your local code authority to assure that the furniture layout is compliant.
- For International Power, specify non-powered panels and use Power Logic components. See Specification Guide for more information on Power Logic.
- For Chicago power, specify non-powered panels without a base raceway cover and separately specify Chicago power retrofit kit.

Basic Monolithic Fabric Panel with Steel Top Cap — Powered

PLACES

	Actual Height	Width	Number ①	Fabric Grade						
				A	B	C	E	F	G	
Fabric Surface — Low Profile Steel Top Cap	30"(762mm)	12"(305mm)	HMP-1230-	\$1661.09	\$1691.07	\$1697.41	\$1708.15	\$1713.49	\$1723.59	
		18"(457mm)	HMP-1830-	1812.37	1831.93	1854.73	1903.33	1936.93	1956.37	
		24"(610mm)	HMP-2430-	1945.93	1985.05	2030.65	2127.85	2195.05	2233.93	
		30"(762mm)	HMP-3030-	2079.49	2138.17	2206.57	2352.37	2453.17	2511.49	
		36"(914mm)	HMP-3630-	2213.05	2291.29	2382.49	2576.89	2711.29	2789.05	
		42"(1067mm)	HMP-4230-	2346.61	2444.41	2558.41	2801.41	2969.41	3066.61	
		48"(1219mm)	HMP-4830-	2480.17	2597.53	2734.33	3025.93	3227.53	3344.17	
		54"(1372mm)	HMP-5430-	2613.73	2750.65	2910.25	3250.45	3485.65	3621.73	
		60"(1524mm)	HMP-6030-	2747.29	2903.77	3086.17	3474.97	3743.77	3899.29	
		37"(940mm)	12"(305mm)	HMP-1237-	\$1724.31	\$1733.93	\$1742.71	\$1767.33	\$1783.27	\$1792.63
			18"(457mm)	HMP-1837-	1881.71	1912.45	1945.47	2020.25	2072.91	2101.95
			24"(610mm)	HMP-2437-	2021.39	2073.25	2130.51	2255.45	2344.83	2393.55
			30"(762mm)	HMP-3037-	2161.07	2234.05	2315.55	2490.65	2616.75	2685.15
			36"(914mm)	HMP-3637-	2300.75	2394.85	2500.59	2725.85	2888.67	2976.75
			42"(1067mm)	HMP-4237-	2440.43	2555.65	2685.63	2961.05	3160.59	3268.35
			48"(1219mm)	HMP-4837-	2580.11	2716.45	2870.67	3196.25	3432.51	3559.95
			54"(1372mm)	HMP-5437-	2719.79	2877.25	3055.71	3431.45	3704.43	3851.55
			60"(1524mm)	HMP-6037-	2859.47	3038.05	3240.75	3666.65	3976.35	4143.15
		44"(1118mm)	12"(305mm)	HMP-1244-	\$1785.03	\$1803.55	\$1824.77	\$1869.29	\$1900.35	\$1919.07
			18"(457mm)	HMP-1844-	1947.71	1983.03	2028.61	2121.61	2186.15	2224.43
			24"(610mm)	HMP-2444-	2092.67	2144.79	2214.73	2356.21	2454.23	2512.07
			30"(762mm)	HMP-3044-	2237.63	2306.55	2400.85	2590.81	2722.31	2799.71
			36"(914mm)	HMP-3644-	2382.59	2468.31	2586.97	2825.41	2990.39	3087.35
			42"(1067mm)	HMP-4244-	2527.55	2630.07	2773.09	3060.01	3258.47	3374.99
		48"(1219mm)	HMP-4844-	2672.51	2791.83	2959.21	3294.61	3526.55	3662.63	
		54"(1372mm)	HMP-5444-	2817.47	2953.59	3145.33	3529.21	3794.63	3950.27	
		60"(1524mm)	HMP-6044-	2962.43	3115.35	3331.45	3763.81	4062.71	4237.91	
	50"(1270mm)	12"(305mm)	HMP-1250-	\$1830.57	\$1855.91	\$1884.83	\$1946.93	\$1987.37	\$2012.65	
		18"(457mm)	HMP-1850-	1998.53	2046.79	2100.91	2216.53	2295.13	2343.09	
		24"(610mm)	HMP-2450-	2148.77	2219.95	2299.27	2468.41	2585.17	2655.81	
		30"(762mm)	HMP-3050-	2299.01	2393.11	2497.63	2720.29	2875.21	2968.53	
		36"(914mm)	HMP-3650-	2449.25	2566.27	2695.99	2972.17	3165.25	3281.25	
		42"(1067mm)	HMP-4250-	2599.49	2739.43	2894.35	3224.05	3455.29	3593.97	
		48"(1219mm)	HMP-4850-	2749.73	2912.59	3092.71	3475.93	3745.33	3906.69	
		54"(1372mm)	HMP-5450-	2899.97	3085.75	3291.07	3727.81	4035.37	4219.41	
		60"(1524mm)	HMP-6050-	3050.21	3258.91	3489.43	3979.69	4325.41	4532.13	
	56"(1422mm)	12"(305mm)	HMP-1256-	\$1876.15	\$1909.09	\$1944.89	\$2022.83	\$2075.97	\$2108.81	
		18"(457mm)	HMP-1856-	2051.67	2107.53	2170.69	2304.91	2397.17	2452.93	
		24"(610mm)	HMP-2456-	2209.47	2288.25	2378.77	2569.27	2700.65	2779.33	
		30"(762mm)	HMP-3056-	2367.27	2468.97	2586.85	2833.63	3004.13	3105.73	
		36"(914mm)	HMP-3656-	2525.07	2649.69	2794.93	3097.99	3307.61	3432.13	
		42"(1067mm)	HMP-4256-	2682.87	2830.41	3003.01	3362.35	3611.09	3758.53	
		48"(1219mm)	HMP-4856-	2840.67	3011.13	3211.09	3626.71	3914.57	4084.93	
		54"(1372mm)	HMP-5456-	2998.47	3191.85	3419.17	3891.07	4218.05	4411.33	
		60"(1524mm)	HMP-6056-	3156.27	3372.57	3627.25	4155.43	4521.53	4737.73	
	64"(1626mm)	12"(305mm)	HMP-1264-	\$1919.07	\$1957.05	\$2001.79	\$2093.69	\$2159.37	\$2197.29	
		18"(457mm)	HMP-1864-	2103.83	2167.61	2239.59	2392.33	2498.81	2562.41	
		24"(610mm)	HMP-2464-	2270.87	2360.45	2459.67	2673.25	2820.53	2909.81	
		30"(762mm)	HMP-3064-	2437.91	2553.29	2679.75	2954.17	3142.25	3257.21	
		36"(914mm)	HMP-3664-	2604.95	2746.13	2899.83	3235.09	3463.97	3604.61	
		42"(1067mm)	HMP-4264-	2771.99	2938.97	3119.91	3516.01	3785.69	3952.01	
		48"(1219mm)	HMP-4864-	2939.03	3131.81	3339.99	3796.93	4107.41	4299.41	
		54"(1372mm)	HMP-5464-	3106.07	3324.65	3560.07	4077.85	4429.13	4646.81	
		60"(1524mm)	HMP-6064-	3273.11	3517.49	3780.15	4358.77	4750.85	4994.21	
	68"(1727mm)	12"(305mm)	HMP-1268-	\$1957.05	\$2083.57	\$2145.99	\$2278.37	\$2369.35	\$2425.05	
		18"(457mm)	HMP-1868-	2152.37	2306.37	2397.59	2595.13	2729.79	2811.53	
		24"(610mm)	HMP-2468-	2329.97	2511.45	2631.47	2894.17	3072.51	3180.29	
		30"(762mm)	HMP-3068-	2507.57	2716.53	2865.35	3193.21	3415.23	3549.05	
		36"(914mm)	HMP-3668-	2685.17	2921.61	3099.23	3492.25	3757.95	3917.81	
		42"(1067mm)	HMP-4268-	2862.77	3126.69	3333.11	3791.29	4100.67	4286.57	
		48"(1219mm)	HMP-4868-	3040.37	3331.77	3566.99	4090.33	4443.39	4655.33	
		54"(1372mm)	HMP-5468-	3217.97	3536.85	3800.87	4389.37	4786.11	5024.09	
		60"(1524mm)	HMP-6068-	3395.57	3741.93	4034.75	4688.41	5128.83	5392.85	
	82"(2083mm)	12"(305mm)	HMP-1282-	\$2253.07	\$2344.11	\$2445.31	\$2655.25	\$2804.49	\$2893.03	
		18"(457mm)	HMP-1882-	2505.99	2632.07	2774.31	3067.53	3276.17	3399.51	
		24"(610mm)	HMP-2482-	2741.19	2902.31	3085.59	3462.09	3730.13	3888.27	
		30"(762mm)	HMP-3082-	2976.39	3172.55	3396.87	3856.65	4184.09	4377.03	
		36"(914mm)	HMP-3682-	3211.59	3442.79	3708.15	4251.21	4638.05	4865.79	
		42"(1067mm)	HMP-4282-	3446.79	3713.03	4019.43	4645.77	5092.01	5354.55	
		48"(1219mm)	HMP-4882-	3681.99	3983.27	4330.71	5040.33	5545.97	5843.31	
		54"(1372mm)	HMP-5482-	3917.19	4253.51	4641.99	5434.89	5999.93	6332.07	
		60"(1524mm)	HMP-6082-	4152.39	4523.75	4953.27	5829.45	6453.89	6820.83	

High-Performance Monolithic Fabric Panel with Steel Top Cap — No Power

PLACES

Fabric

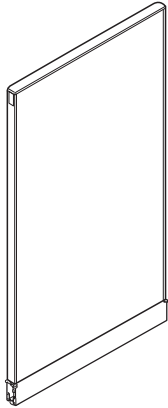

HFN-H (Non-Powered)

Features

- Includes non-powered or powered panel assembly, low profile top cap, with or without one-piece base raceway cover, 1.6 hinge kits, side trim rails, leveling glides and carpet gripper; power distribution assembly/flex connector(s) when power is specified. .6 base raceway end caps are shipped with each panel. Order additional as necessary.
- Acoustical panel surfaces.
- Panel surfaces may have the same fabric on both sides or a different fabric on each side.
- Panel thickness is 2"(51mm).
- Base raceway is 4"(102mm) high.
- Powered raceway with or without raceway cover requires modified catalog number and list price.
- Powered panels are available for countries that utilize 120 volt 60 hertz electrical systems and U.S. configured plugs and outlets.
- Shipped with unassembled top cap, base raceway cover and side trim rails.

Specification Tips

- Panels will accept add-on panels up to a combined height of 82"(2083mm). For aesthetic consistency, specify PLACES add-on panels.
- Flex connectors provided for powered monolithic panels accommodate straight in-line, inside 90°, and inside 180° conditions (if applicable).
- Receptacles for powered panels must be specified separately.
- Raceway cover must be separately specified for option -HE (no raceway cover).
- Additional base raceway end caps will need to be specified if finish post are not covered.
- High Performance Monolithic panels are available in Biscotti, Savory, Striae and Mahogany only.

To Order, Specify:

- 1) Product number, including:

Options:

H With Raceway Cover

HE Without Raceway Cover, deduct \$175.26 list

- 2) Fabric/colorway for panel side cover
- 3) Fabric/colorway for panel side trim rails
- 4) Trim color for raceway cover, side housings and end caps.
- 5) Trim color for top cap and side trim rails.

Note: For mixed order pricing will be determined by the sum of the upcharges. Please refer to the electronic catalog.

NOTES:

- Powered panels with raceway covers ship with receptacle ports in the base raceway cover. Receptacle ports on the raceway cover measure 2.35"(60mm) top-to-bottom and 2.88"(73mm) side-to-side.
- Non-powered panels ship without receptacle ports in the base raceway cover.
- Powered panels with Power Distribution Assemblies (PDA) without raceway covers require separately specified base raceway covers for power and communication port locations other than the standard powered base raceway cover.
- New York City (NYC) electrical applications require field installation of PDA.
- New York Port Authority (NYPA) electrical applications require metal raceway covers. To order, specify NYC powered panels without raceway cover and separately specify metal covers through Haworth e-Parts.
- Some building codes may restrict the use of panel heights greater than 69"(1753mm). Consult your local code authority to assure that the furniture layout is compliant.
- For International Power, specify non-powered panels and use Power Logic components. See Specification Guide for more information on Power Logic.
- For Chicago power, specify non-powered panels without a base raceway cover and separately specify Chicago power retrofit kit.



High-Performance Monolithic Fabric Panel with Steel Top Cap — No Power

PLACES

Fabric	Actual Height	Width	Number ①	Fabric Grade	
				A	B
30"(762mm)	12"(305mm)	12"(305mm)	HFN-1230-	\$1507.04	\$1537.02
			HFN-1830-	1671.08	1690.64
			HFN-2430-	1835.12	1874.24
			HFN-3030-	1999.16	2057.84
			HFN-3630-	2163.20	2241.44
			HFN-4230-	2327.24	2425.04
			HFN-4830-	2491.28	2608.64
			HFN-5430-	2655.32	2792.24
37"(940mm)	12"(305mm)	12"(305mm)	HFN-1237-	\$1748.04	\$1579.88
			HFN-1837-	1748.04	1778.78
			HFN-2437-	1925.82	1977.68
			HFN-3037-	2103.60	2176.58
			HFN-3637-	2281.38	2375.48
			HFN-4237-	2459.16	2574.38
			HFN-4837-	2636.94	2773.28
			HFN-5437-	2814.72	2972.18
44"(1118mm)	12"(305mm)	12"(305mm)	HFN-1244-	\$1630.98	\$1649.50
			HFN-1844-	1808.94	1844.26
			HFN-2444-	1986.90	2039.02
			HFN-3044-	2164.86	2233.78
			HFN-3644-	2342.82	2428.54
			HFN-4244-	2520.78	2623.30
			HFN-4844-	2698.74	2818.06
			HFN-5444-	2876.70	3012.82
50"(1270mm)	12"(305mm)	12"(305mm)	HFN-1250-	\$1676.52	\$1701.86
			HFN-1850-	1857.24	1905.50
			HFN-2450-	2037.96	2109.14
			HFN-3050-	2218.68	2312.78
			HFN-3650-	2399.40	2516.42
			HFN-4250-	2580.12	2720.06
			HFN-4850-	2760.84	2923.70
			HFN-5450-	2941.56	3127.34
64"(1626mm)	12"(305mm)	12"(305mm)	HFN-1264-	\$1765.02	\$1803.00
			HFN-1864-	1965.06	2028.84
			HFN-2464-	2165.10	2254.68
			HFN-3064-	2365.14	2480.52
			HFN-3664-	2565.18	2706.36
			HFN-4264-	2765.22	2932.20
			HFN-4864-	2965.26	3158.04
			HFN-5464-	3165.30	3383.88
68"(1727mm)	12"(305mm)	12"(305mm)	HFN-1268-	\$1803.00	\$1929.52
			HFN-1868-	2026.14	2180.14
			HFN-2468-	2249.28	2430.76
			HFN-3068-	2472.42	2681.38
			HFN-3668-	2695.56	2932.00
			HFN-4268-	2918.70	3182.62
			HFN-4868-	3141.84	3433.24
			HFN-5468-	3364.98	3683.86
82"(2083mm)	12"(305mm)	12"(305mm)	HFN-1282-	\$2099.02	\$2190.06
			HFN-1882-	2407.60	2533.68
			HFN-2482-	2716.18	2877.30
			HFN-3082-	3024.76	3220.92
			HFN-3682-	3333.34	3564.54
			HFN-4282-	3641.92	3908.16
			HFN-4882-	3950.50	4251.78
			HFN-5482-	4259.08	4595.40
60"(1524mm)	12"(305mm)	12"(305mm)	HFN-6082-	4567.66	4939.02

OBSOLETE! March 2024



High-Performance Monolithic Fabric Panel with Steel Top Cap — Powered PLACES

Fabric

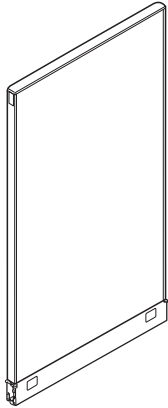

HFP-H (3-circuit)
 HFP-H2 (4-circuit, 2+2)
 HFP-H4 (4-circuit, 3+1)



Features

- Includes non-powered or powered panel assembly, low profile top cap, with or without one-piece base raceway cover, 1.6 hinge kits, side trim rails, leveling glides and carpet gripper; power distribution assembly/flex connector(s) when power is specified. .6 base raceway end caps are shipped with each panel. Order additional as necessary.
- Acoustical panel surfaces.
- Panel surfaces may have the same fabric on both sides or a different fabric on each side.
- Panel thickness is 2"(51mm).
- Base raceway is 4"(102mm) high.
- Powered raceway with or without raceway cover requires modified catalog number and list price.
- Powered panels are available for countries that utilize 120 volt 60 hertz electrical systems and U.S. configured plugs and outlets.
- Shipped with unassembled top cap, base raceway cover and side trim rails.

Specification Tips

- Panels will accept add-on panels up to a combined height of 82"(2083mm). For aesthetic consistency, specify PLACES add-on panels.
- Flex connectors provided for powered monolithic panels accommodate straight in-line, inside 90°, and inside 180° conditions (if applicable).
- Receptacles for powered panels must be specified separately.
- Raceway cover must be separately specified for options -HE, HYE, H2E, H2YE, H4E or H4YE (no raceway cover).
- Additional base raceway end caps will need to be specified if finish post are not covered.
- High Performance Monolithic panels are available in Biscotti, Savory, Striae and others only.

To Order, Specify:

- Product number, including:

1) 3-Circuit

- H** With Raceway Cover
- HE** Without Raceway Cover, deduct \$192.98 list
- HY** NYC with Raceway Cover
- HYE** NYC without Raceway Cover, deduct \$192.98 list

4-Circuit, 2+2

- H2** With Raceway Cover
- H2E** Without Raceway Cover, deduct \$192.98 list
- H2Y** NYC with Raceway Cover
- H2YE** NYC without Raceway Cover, deduct \$192.98 list

4-Circuit, 3+1

- H4** With Raceway Cover
- H4E** Without Raceway Cover, deduct \$192.98 list
- H4Y** NYC with Raceway Cover
- H4YE** NYC without Raceway Cover, deduct \$192.98 list

- Fabric/colorway for panel side one.
- Fabric/colorway for panel side two.
- Trim color for raceway cover, glide housings and end caps.
- Trim color for top cap and side trim rails.

Note: For mixed grade surfaces pricing will be determined by the sum of the upcharges. Please refer to the electronic catalog.

NOTES:

- Powered panels with raceway covers ship with receptacle ports in the base raceway cover. Receptacle ports on the raceway cover measure 2.35"(60mm) top-to-bottom and 2.88"(73mm) side-to-side.
- Non-powered panels ship without receptacle ports in the base raceway cover.
- Powered panels with Power Distribution Assembly (PDA) but without raceway covers require separately specified base raceway covers for power and communication port locations other than the standard powered base raceway cover.
- New York City (NYC) electrical applications require field installation of PDA.
- New York Port Authority (NYP&A) electrical applications require metal raceway covers. To order, specify NYC powered panels without raceway cover and separately specify metal covers through Haworth e-Products.
- Some building codes may restrict the use of panel heights greater than 69"(1753mm). Consult your local code authority to assure that the furniture layout is compliant.
- For International Power, specify non-powered panels and use Power Logic components. See Specification Guide for more information on Power Logic.
- For Chicago power applications, specify non-powered panels without a base raceway cover and separately specify Chicago power retrofit kit.

High-Performance Monolithic Fabric Panel with Steel Top Cap — Powered

PLACES

Fabric	Actual Height	Width	Number ①	Fabric Grade	
				A	B
30"(762mm)	12"(305mm)	12"(305mm)	HFP-1230-	\$1987.44	\$2017.42
			HFP-1830-	2169.20	2188.76
			HFP-2430-	2333.24	2372.36
			HFP-3030-	2497.28	2555.96
			HFP-3630-	2661.32	2739.56
			HFP-4230-	2825.36	2923.16
			HFP-4830-	2989.40	3106.76
			HFP-5430-	3153.44	3290.36
37"(940mm)	12"(305mm)	12"(305mm)	HFP-1237-	\$2060.28	\$2060.28
			HFP-1837-	2246.16	2276.90
			HFP-2437-	2423.94	2475.80
			HFP-3037-	2601.72	2674.70
			HFP-3637-	2779.50	2873.60
			HFP-4237-	2957.28	3072.50
			HFP-4837-	3135.06	3271.40
			HFP-5437-	3312.84	3470.30
44"(1118mm)	12"(305mm)	12"(305mm)	HFP-1244-	\$2111.38	\$2129.90
			HFP-1844-	2307.06	2342.38
			HFP-2444-	2485.02	2537.14
			HFP-3044-	2662.98	2731.90
			HFP-3644-	2840.94	2926.66
			HFP-4244-	3018.90	3121.42
			HFP-4844-	3196.86	3316.18
			HFP-5444-	3374.82	3510.94
50"(1270mm)	12"(305mm)	12"(305mm)	HFP-1250-	\$2156.92	\$2182.26
			HFP-1850-	2355.36	2403.62
			HFP-2450-	2536.08	2607.26
			HFP-3050-	2716.80	2810.90
			HFP-3650-	2897.52	3014.54
			HFP-4250-	3078.24	3218.18
			HFP-4850-	3258.96	3421.82
			HFP-5450-	3439.68	3625.46
64"(1626mm)	12"(305mm)	12"(305mm)	HFP-1264-	\$2245.42	\$2283.40
			HFP-1864-	2463.18	2526.96
			HFP-2464-	2663.22	2752.80
			HFP-3064-	2863.26	2978.64
			HFP-3664-	3063.30	3204.48
			HFP-4264-	3263.34	3430.32
			HFP-4864-	3463.38	3656.16
			HFP-5464-	3663.42	3882.00
68"(1727mm)	12"(305mm)	12"(305mm)	HFP-1268-	\$2283.40	\$2409.92
			HFP-1868-	2524.26	2678.26
			HFP-2468-	2747.40	2928.88
			HFP-3068-	2970.54	3179.50
			HFP-3668-	3193.68	3430.12
			HFP-4268-	3416.82	3680.74
			HFP-4868-	3639.96	3931.36
			HFP-5468-	3863.10	4181.98
82"(2083mm)	12"(305mm)	12"(305mm)	HFP-1282-	\$2579.42	\$2670.46
			HFP-1882-	2905.72	3031.80
			HFP-2482-	3214.30	3375.42
			HFP-3082-	3522.88	3719.04
			HFP-3682-	3831.46	4062.66
			HFP-4282-	4140.04	4406.28
			HFP-4882-	4448.62	4749.90
			HFP-5482-	4757.20	5093.52
60"(1524mm)	12"(305mm)	12"(305mm)	HFP-6082-	5065.78	5437.14

OBSOLETE! March 2024

Glazed Monolithic Panels with Steel Top Cap — No Power

PLACES

Glazed

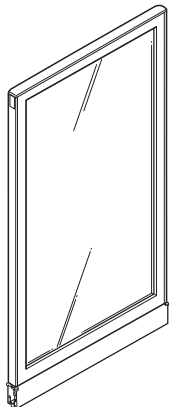

HGN (Non-Powered)

Features

- Includes non-powered or powered panel assembly, low profile top cap, with or without one-piece base raceway cover, 1.6 hinge kits, side trim rails, leveling glides and carpet gripper; power distribution assembly/flex connector(s) when power is specified. .6 base raceway end caps are shipped with each panel. Order additional as necessary.
- Base raceway is 4"(102mm) high.
- Powered raceway with or without raceway cover requires modified catalog number and list price.
- Powered panels are available for countries that utilize 120 volt 60 hertz electrical systems and U.S. configured plugs and outlets.
- Shipped with unassembled top cap, base raceway cover and side trim rails.
- Does not accept top feed modules.

Specification Tips

- Panels will accept glazed add-on panels up to a combined height of 82"(2083mm). For aesthetic consistency, specify PLACES add-on panels.
- Glazed panels accept muntin kits and wainscot kits.
- Flex connectors provided for powered monolithic panels accommodate straight in-line, inside 90°, and inside 120° conditions (if applicable).
- Receptacles for powered panels must be specified separately.
- Raceway cover must be separately specified for option -E (no raceway cover).
- Additional base raceway end caps will need to be specified if finish posts are not ordered.

To Order, Specify:

- 1) Product number, including:

① Option:

- E** Without Raceway Cover, deduct **\$175.26** list (No option required for Raceway Cover)

- 2) Glazing finish color.
- 3) Trim color for raceway cover, glide housings and end caps.
- 4) Trim color for frame, top cap and side trim rails.

NOTES:

- Powered panels with raceway covers ship with receptacle ports in the base raceway cover. Receptacle ports on the raceway cover measure 2.35"(60mm) top-to-bottom and 2.88"(73mm) side-to-side.
- Non-powered panels ship without receptacle ports in the base raceway cover.
- Powered panels with Power Distribution Assemblies (PDA) but without raceway covers require separately specified base raceway covers for power and communication port locations other than the standard powered base raceway cover.
- New York City (NYC) electrical applications require field installation of PDA.
- New York Port Authority (NYPA) electrical applications require metal raceway covers. To order, specify NYC powered panels without raceway cover and separately specify metal covers through Haworth e-Parts.
- Some building codes may restrict the use of panel heights greater than 69"(1753mm). Consult your local code authority to assure that the furniture layout is compliant.
- For International Power, specify non-powered panels and use Power Logic components. See Specification Guide for more information on Power Logic.
- For Chicago power, specify non-powered panels without a base raceway cover and separately specify Chicago power retrofit kit.

Glazed Monolithic Panels with Steel Top Cap — No Power

PLACES

	Actual Height	Width	Number ①	Clear	Frosted
Glazed	44"(1118mm)	12"(305mm)	HGN-1244-■	\$1755.43	\$ 2547.47
		18"(457mm)	HGN-1844-■	2066.98	3432.34
		24"(610mm)	HGN-2444-■	2376.50	4311.43
		30"(762mm)	HGN-3044-■	2688.05	5196.30
		36"(914mm)	HGN-3644-■	2997.56	6075.38
		42"(1067mm)	HGN-4244-■	3307.08	6954.47
		48"(1219mm)	HGN-4844-■	3618.63	7839.34
		54"(1372mm)	HGN-5444-■	3928.15	8718.43
	60"(1524mm)	HGN-6044-■	4239.70	9603.30	
	50"(1270mm)	12"(305mm)	HGN-1250-■	\$1868.13	\$ 2868.11
		18"(457mm)	HGN-1850-■	2179.68	3752.98
		24"(610mm)	HGN-2450-■	2489.20	4632.07
		30"(762mm)	HGN-3050-■	2800.75	5516.94
		36"(914mm)	HGN-3650-■	3110.26	6396.02
		42"(1067mm)	HGN-4250-■	3419.78	7275.11
		48"(1219mm)	HGN-4850-■	3731.33	8159.98
		54"(1372mm)	HGN-5450-■	4040.85	9039.07
	60"(1524mm)	HGN-6050-■	4352.40	9923.94	
	64"(1626mm)	12"(305mm)	HGN-1264-■	\$2129.63	\$ 3612.07
		18"(457mm)	HGN-1864-■	2441.18	4496.94
		24"(610mm)	HGN-2464-■	2750.70	5376.03
		30"(762mm)	HGN-3064-■	3062.25	6260.90
		36"(914mm)	HGN-3664-■	3371.76	7139.98
		42"(1067mm)	HGN-4264-■	3681.28	8019.07
		48"(1219mm)	HGN-4864-■	3992.83	8903.94
		54"(1372mm)	HGN-5464-■	4302.35	9783.03
	60"(1524mm)	HGN-6064-■	4613.90	10667.90	
	68"(1727mm)	12"(305mm)	HGN-1268-■	\$2204.76	\$ 3825.83
		18"(457mm)	HGN-1868-■	2516.31	4710.70
		24"(610mm)	HGN-2468-■	2825.83	5589.79
		30"(762mm)	HGN-3068-■	3137.38	6474.66
		36"(914mm)	HGN-3668-■	3446.89	7353.74
		42"(1067mm)	HGN-4268-■	3756.41	8232.83
		48"(1219mm)	HGN-4868-■	4067.96	9117.70
		54"(1372mm)	HGN-5468-■	4377.48	9996.79
	60"(1524mm)	HGN-6068-■	4689.03	10881.66	
	82"(2083mm)	12"(305mm)	HGN-1282-■	\$2467.00	\$ 4571.89
		18"(457mm)	HGN-1882-■	2778.55	5456.76
		24"(610mm)	HGN-2482-■	3088.07	6335.85
		30"(762mm)	HGN-3082-■	3399.62	7220.72
		36"(914mm)	HGN-3682-■	3709.13	8099.80
		42"(1067mm)	HGN-4282-■	4018.65	8978.89
		48"(1219mm)	HGN-4882-■	4330.20	9863.76
		54"(1372mm)	HGN-5482-■	4639.72	10742.85
	60"(1524mm)	HGN-6082-■	4951.27	11627.72	

Glazed Monolithic Panels with Steel Top Cap — Powered

PLACES

Glazed

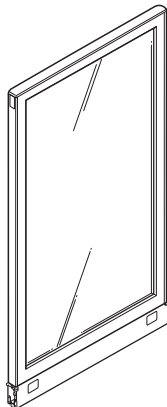

HGP (3-circuit)
HGP-2 (4-circuit, 2+2)
HGP-4 (4-circuit, 3+1)



Features

- Includes non-powered or powered panel assembly, low profile top cap, with or without one-piece base raceway cover, 1.6 hinge kits, side trim rails, leveling glides and carpet gripper; power distribution assembly/flex connector(s) when power is specified. .6 base raceway end caps are shipped with each panel. Order additional as necessary.
- Base raceway is 4"(102mm) high.
- Powered raceway with or without raceway cover requires modified catalog number and list price.
- Powered panels are available for countries that utilize 120 volt 60 hertz electrical systems and U.S. configured plugs and outlets.
- Shipped with unassembled top cap, base raceway cover and side trim rails.
- Does not accept top feed modules.

Specification Tips

- Panels will accept glazed add-on panels up to a combined height of 82"(2083mm). For aesthetic consistency, specify PLACES add-on panels.
- Glazed panels accept muntin kits and wainscot kits.
- Flex connectors provided for powered monolithic panels accommodate straight in-line, inside 90°, and inside 120° conditions (if applicable).
- Receptacles for powered panels must be specified separately.
- Raceway cover must be separately specified for option -E, YE, 2E, 2YE, 4E or 4YE (no raceway cover).
- Additional base raceway end caps will need to be specified if finish posts are not ordered.

To Order, Specify:

1) Product number, including:

① 3-Circuit

- E** Without Raceway Cover, deduct **\$192.98** list
- Y** NYC with Raceway Cover, deduct **\$70.88** list
- YE** NYC without Raceway Cover, deduct **\$263.86** list (No option required with Raceway Cover)

4-Circuit, 2+2

- 2** With Raceway Cover
- 2E** Without Raceway Cover, deduct **\$192.98** list
- 2Y** NYC with Raceway Cover, deduct **\$70.88** list
- 2YE** NYC without Raceway Cover, deduct **\$263.86** list

4-Circuit, 3+1

- 4** With Raceway Cover
- 4E** Without Raceway Cover, deduct **\$192.98** list
- 4Y** NYC with Raceway Cover, deduct **\$70.88** list
- 4YE** NYC without Raceway Cover, deduct **\$263.86** list

2) Glazing finish color.

3) Trim color for raceway cover, glide housings and end caps.

4) Trim color for frame, top cap and side trim rails.

NOTES:

- *Powered panels with raceway covers ship with receptacle ports in the base raceway cover. Receptacle ports on the raceway cover measure 2.35"(60mm) top-to-bottom and 2.88"(73mm) side-to-side.*
- *Non-powered panels ship without receptacle ports in the base raceway cover.*
- *Powered panels with Power Distribution Assemblies (PDA) but without raceway covers require separately specified base raceway covers for power and communication port locations other than the standard powered base raceway cover.*
- *New York City (NYC) electrical applications require field installation of PDA.*
- *New York Port Authority (NYPA) electrical applications require metal raceway covers. To order, specify NYC powered panels without raceway cover and separately specify metal covers through Haworth e-Parts.*
- *Some building codes may restrict the use of panel heights greater than 69"(1753mm). Consult your local code authority to assure that the furniture layout is compliant.*
- *For International Power, specify non-powered panels and use Power Logic components. See Specification Guide for more information on Power Logic.*
- *For Chicago power, specify non-powered panels without a base raceway cover and separately specify Chicago power retrofit kit.*

Glazed Monolithic Panels with Steel Top Cap — Powered

PLACES

	Actual Height	Width	Number ①	Clear	Frosted
Glazed	44"(1118mm)	12"(305mm)	HGP-1244-■ ■ ■	\$2306.71	\$ 3098.75
		18"(457mm)	HGP-1844-■ ■ ■	2635.98	4001.34
		24"(610mm)	HGP-2444-■ ■ ■	2945.50	4880.43
		30"(762mm)	HGP-3044-■ ■ ■	3257.05	5765.30
		36"(914mm)	HGP-3644-■ ■ ■	3566.56	6644.38
		42"(1067mm)	HGP-4244-■ ■ ■	3876.08	7523.47
		48"(1219mm)	HGP-4844-■ ■ ■	4187.63	8408.34
		54"(1372mm)	HGP-5444-■ ■ ■	4497.15	9287.43
	60"(1524mm)	HGP-6044-■ ■ ■	4808.70	10172.30	
	50"(1270mm)	12"(305mm)	HGP-1250-■ ■ ■	\$2419.41	\$ 3419.39
		18"(457mm)	HGP-1850-■ ■ ■	2748.68	4321.98
		24"(610mm)	HGP-2450-■ ■ ■	3058.20	5201.07
		30"(762mm)	HGP-3050-■ ■ ■	3369.75	6085.94
		36"(914mm)	HGP-3650-■ ■ ■	3679.26	6965.02
		42"(1067mm)	HGP-4250-■ ■ ■	3988.78	7844.11
		48"(1219mm)	HGP-4850-■ ■ ■	4300.33	8728.98
		54"(1372mm)	HGP-5450-■ ■ ■	4609.85	9608.07
	60"(1524mm)	HGP-6050-■ ■ ■	4921.40	10492.94	
	64"(1626mm)	12"(305mm)	HGP-1264-■ ■ ■	\$2680.91	\$ 4163.35
		18"(457mm)	HGP-1864-■ ■ ■	3010.18	5065.94
		24"(610mm)	HGP-2464-■ ■ ■	3319.70	5945.03
		30"(762mm)	HGP-3064-■ ■ ■	3631.25	6829.90
		36"(914mm)	HGP-3664-■ ■ ■	3940.76	7708.98
		42"(1067mm)	HGP-4264-■ ■ ■	4250.28	8588.07
		48"(1219mm)	HGP-4864-■ ■ ■	4561.83	9472.94
		54"(1372mm)	HGP-5464-■ ■ ■	4871.35	10352.03
	60"(1524mm)	HGP-6064-■ ■ ■	5182.90	11236.90	
	68"(1727mm)	12"(305mm)	HGP-1268-■ ■ ■	\$2756.04	\$ 4377.11
		18"(457mm)	HGP-1868-■ ■ ■	3085.31	5279.70
		24"(610mm)	HGP-2468-■ ■ ■	3394.83	6158.79
		30"(762mm)	HGP-3068-■ ■ ■	3706.38	7043.66
		36"(914mm)	HGP-3668-■ ■ ■	4015.89	7922.74
		42"(1067mm)	HGP-4268-■ ■ ■	4325.41	8801.83
		48"(1219mm)	HGP-4868-■ ■ ■	4636.96	9686.70
		54"(1372mm)	HGP-5468-■ ■ ■	4946.48	10565.79
	60"(1524mm)	HGP-6068-■ ■ ■	5258.03	11450.66	
	82"(2083mm)	12"(305mm)	HGP-1282-■ ■ ■	\$3018.28	\$ 5123.17
		18"(457mm)	HGP-1882-■ ■ ■	3347.55	6025.76
		24"(610mm)	HGP-2482-■ ■ ■	3657.07	6904.85
		30"(762mm)	HGP-3082-■ ■ ■	3968.62	7789.72
		36"(914mm)	HGP-3682-■ ■ ■	4278.13	8668.80
		42"(1067mm)	HGP-4282-■ ■ ■	4587.65	9547.89
		48"(1219mm)	HGP-4882-■ ■ ■	4899.20	10432.76
		54"(1372mm)	HGP-5482-■ ■ ■	5208.72	11311.85
	60"(1524mm)	HGP-6082-■ ■ ■	5520.27	12196.72	

Fabric Add-On Panel

PLACES

Fabric

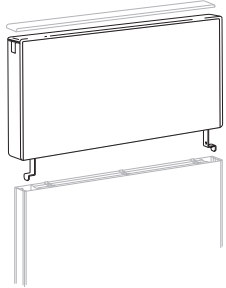

HAF

NOTE:

*Add-on panels cannot be used with add-on panels ordered with the SP** prefix.

Features

- Includes panel, vertical connector (bayonet), light block, side trim rails, two full hinge sets, one side trim rail cover and top cap clips.
- Fabric add-on panels may be installed above any straight fabric base or fabric add-on panels.*
- Both sides in same fabric; one color or different color each side.
- Each base panel will accept two add-on panels.
- Lower Level add-on panel will accept overhead components (load bearing). Second add-on panel (top) is non-load bearing.
- Top rail of add-on panel will provide top wire management.
- Utilizes top cap from base panel.
- Standard finish posts can be used.
- Same construction as PLACES Monolithic fabric panel.

Specification Tips

- Add-on panels may be stacked a maximum of two high in any order of height above a base panel.
- Add-on panel must match panel width.
- Combination of panel and add-on panel cannot exceed 82" (2083mm) in height.
- Cannot be used above any door, glazed, open-frame, or glazed add-on panels.
- Base and add-on panel combinations should match existing base panel heights so that end-of-runs and finish posts can be used without field modification.
- Full-height trim rails required for end-of-run conditions with a base panel and one add-on panel, separately specified.
- For two high add-on panel applications specify separately full-height side trim rail for base panel and one high add on, for two high panel add on location use side trim rail that ships with add-on panel.
- Clerestory can be added above fabric add-on panels.

To Order, Specify:

- 1) Product number.
- 2) Fabric/colorway for add-on panel side one.
- 3) Fabric/colorway for add-on panel side two.
- 4) Trim color for side trim rails and trim strip.

Note: For mixed grade surfaces pricing will be determined by the sum of the upcharges. Please refer to the electronic catalog.

Fabric Add-On Panel

PLACES

Fabric	Actual Height	Width	Number	Fabric Grade					
				A	B	C	E	F	G
12"(305mm)	12"(305mm)	HAF-1212	\$1258.85	\$1366.65	\$1485.23	\$1743.99	\$1916.51	\$2024.32	
	18"(457mm)	HAF-1812	1318.68	1435.59	1564.16	1844.75	2031.85	2148.76	
	24"(610mm)	HAF-2412	1378.51	1504.53	1643.09	1945.51	2147.19	2273.20	
	30"(762mm)	HAF-3012	1438.34	1573.47	1722.02	2046.27	2262.53	2397.64	
	36"(914mm)	HAF-3612	1498.17	1642.41	1800.95	2147.03	2377.87	2522.08	
	42"(1067mm)	HAF-4212	1558.00	1711.35	1879.88	2247.79	2493.21	2646.52	
	48"(1219mm)	HAF-4812	1617.83	1780.29	1958.81	2348.55	2608.55	2770.96	
	54"(1372mm)	HAF-5412	1677.66	1849.23	2037.74	2449.31	2723.89	2895.40	
	60"(1524mm)	HAF-6012	1737.49	1918.17	2116.67	2550.07	2839.23	3019.84	
14"(356mm)	12"(305mm)	HAF-1214	\$1318.68	\$1435.59	\$1564.16	\$1844.75	\$2031.85	\$2148.76	
	18"(457mm)	HAF-1814	1378.51	1504.53	1643.09	1945.51	2147.19	2273.20	
	24"(610mm)	HAF-2414	1438.34	1573.47	1722.02	2046.27	2262.53	2397.64	
	30"(762mm)	HAF-3014	1498.17	1642.41	1800.95	2147.03	2377.87	2522.08	
	36"(914mm)	HAF-3614	1558.00	1711.35	1879.88	2247.79	2493.21	2646.52	
	42"(1067mm)	HAF-4214	1617.83	1780.29	1958.81	2348.55	2608.55	2770.96	
	48"(1219mm)	HAF-4814	1677.66	1849.23	2037.74	2449.31	2723.89	2895.40	
	54"(1372mm)	HAF-5414	1737.49	1918.17	2116.67	2550.07	2839.23	3019.84	
	60"(1524mm)	HAF-6014	1797.32	1987.11	2195.60	2650.83	2954.57	3144.28	
18"(437mm)	12"(305mm)	HAF-1218	\$1438.34	\$1573.47	\$1722.02	\$2046.27	\$2262.53	\$2397.64	
	18"(457mm)	HAF-1818	1498.17	1642.41	1800.95	2147.03	2377.87	2522.08	
	24"(610mm)	HAF-2418	1558.00	1711.35	1879.88	2247.79	2493.21	2646.52	
	30"(762mm)	HAF-3018	1617.83	1780.29	1958.81	2348.55	2608.55	2770.96	
	36"(914mm)	HAF-3618	1677.66	1849.23	2037.74	2449.31	2723.89	2895.40	
	42"(1067mm)	HAF-4218	1737.49	1918.17	2116.67	2550.07	2839.23	3019.84	
	48"(1219mm)	HAF-4818	1797.32	1987.11	2195.60	2650.83	2954.57	3144.28	
	54"(1372mm)	HAF-5418	1857.15	2056.05	2274.53	2751.59	3069.91	3268.72	
	60"(1524mm)	HAF-6018	1916.98	2124.99	2353.46	2852.35	3185.25	3393.16	
20"(508mm)	12"(305mm)	HAF-1220	\$1498.17	\$1642.41	\$1800.95	\$2147.03	\$2377.87	\$2522.08	
	18"(457mm)	HAF-1820	1558.00	1711.35	1879.88	2247.79	2493.21	2646.52	
	24"(610mm)	HAF-2420	1617.83	1780.29	1958.81	2348.55	2608.55	2770.96	
	30"(762mm)	HAF-3020	1677.66	1849.23	2037.74	2449.31	2723.89	2895.40	
	36"(914mm)	HAF-3620	1737.49	1918.17	2116.67	2550.07	2839.23	3019.84	
	42"(1067mm)	HAF-4220	1797.32	1987.11	2195.60	2650.83	2954.57	3144.28	
	48"(1219mm)	HAF-4820	1857.15	2056.05	2274.53	2751.59	3069.91	3268.72	
	54"(1372mm)	HAF-5420	1916.98	2124.99	2353.46	2852.35	3185.25	3393.16	
	60"(1524mm)	HAF-6020	1976.81	2193.93	2432.39	2953.11	3300.59	3517.60	
24"(610mm)	12"(305mm)	HAF-1224	\$1617.83	\$1780.29	\$1958.81	\$2348.55	\$2608.55	\$2770.96	
	18"(457mm)	HAF-1824	1677.66	1849.23	2037.74	2449.31	2723.89	2895.40	
	24"(610mm)	HAF-2424	1737.49	1918.17	2116.67	2550.07	2839.23	3019.84	
	30"(762mm)	HAF-3024	1797.32	1987.11	2195.60	2650.83	2954.57	3144.28	
	36"(914mm)	HAF-3624	1857.15	2056.05	2274.53	2751.59	3069.91	3268.72	
	42"(1067mm)	HAF-4224	1916.98	2124.99	2353.46	2852.35	3185.25	3393.16	
	48"(1219mm)	HAF-4824	1976.81	2193.93	2432.39	2953.11	3300.59	3517.60	
	54"(1372mm)	HAF-5424	2036.64	2262.87	2511.32	3053.87	3415.93	3642.04	
	60"(1524mm)	HAF-6024	2096.47	2331.81	2590.25	3154.63	3531.27	3766.48	

Glazed Add-On Panel

PLACES

Glazed

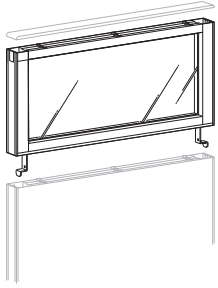

HAG

NOTE:

Add-on panels cannot be used with add-on panels ordered with the SP prefix.*

Features

- Includes panel, vertical connector (bayonet), light block, side trim rails, two full hinge sets, one side trim rail cover, and top cap clips.
- Utilizes top cap from base panel.
- Glazed add-on panels may be installed above any straight fabric, glazed, or open-frame base or add-on panels.*
- Each base panel will accept two add-on panels.
- Glazed add-on panels will not accept any load bearing components.
- Top rail of add-on panel will provide top wire management.
- Textured glazing material is textured on one side only. Recommend installing the textured side to face the interior of the workstation.
- Standard finish post and end-of-run posts can be used.

Specification Tips

- Specify glazed add-on panel based upon the type of panel, fabric (F) or glazed/open-frame (G), that will be directly below the add-on panel.
- Add-on panels may be stacked a maximum of two high in any order of height above a base panel.
- Add-on panel must match base panel width.
- Combination of base panel and add-on panel cannot exceed 82"(2083mm) in height.
- Base and add-on panel combinations should match existing base panel heights so that end-of-runs and finish posts can be used without field modification.
- Cannot be used above doors.
- Does not accept top feed modules.
- To convert a glazed add-on above a fabric monolithic base panel to a glazed add-on above a glazed base panel or (vice versa), a vertical connector (bayonet) retrofit kit is available. Order separately through Haworth e-Parts.
- Full-height trim rails required for end-of-run conditions with a base panel and one add-on panel, separately specified.
- For two high add-on panel applications specify separately full-height side trim rail for base panel and one high add on, for two high panel add on location use side trim rail that ships with add-on panel.
- Clerestory can be added above glazed add-on panels.
- **Patterned Glass (SQ-CM Checks Mix, SQ-ER English Reeded and SQ-VM Vertical Moire) available on 12"(305mm) and 18"(457mm) high add-on panels only.**

To Order, Specify:

- 1) Product number, including:

① Application Designation:

- F** Glazed add-on panel directly above fabric base panel or fabric add-on panel.
 - G** Glazed add-on panel directly above glazed and open frame base panel or glazed add-on panel, add **\$68.18** list.
- 2) Glazing color or glass pattern.
 - 3) Trim color for frame, side trim rails and trim strip.

Glazed Add-On Panel

PLACES

	Actual Height	Width	Number ①	Glass Grade A	C*	D*
Glazed	12"(305mm)	12"(305mm)	HAG-1212-	\$1290.36	\$1683.74	\$1814.87
		18"(457mm)	HAG-1812-	1376.63	1835.55	1992.92
		24"(610mm)	HAG-2412-	1462.90	1987.36	2170.97
		30"(762mm)	HAG-3012-	1549.17	2139.17	2349.02
		36"(914mm)	HAG-3612-	1635.44	2290.98	2527.07
		42"(1067mm)	HAG-4212-	1721.71	2442.79	2705.12
		48"(1219mm)	HAG-4812-	1807.98	2594.60	2883.17
		54"(1372mm)	HAG-5412-	1894.25	2746.41	3061.22
		60"(1524mm)	HAG-6012-	1980.52	2898.22	3239.27
	14"(356mm)	12"(305mm)	HAG-1214-	\$1353.02	N/A	\$1969.31
		18"(457mm)	HAG-1814-	1439.29	N/A	2147.36
		24"(610mm)	HAG-2414-	1525.56	N/A	2325.41
		30"(762mm)	HAG-3014-	1611.83	N/A	2503.46
		36"(914mm)	HAG-3614-	1698.10	N/A	2681.51
		42"(1067mm)	HAG-4214-	1784.37	N/A	2859.56
		48"(1219mm)	HAG-4814-	1870.64	N/A	3037.61
		54"(1372mm)	HAG-5414-	1956.91	N/A	3215.66
		60"(1524mm)	HAG-6014-	2043.18	N/A	3393.71
	18"(457mm)	12"(305mm)	HAG-1218-	\$1478.34	\$2068.34	\$2278.19
		18"(457mm)	HAG-1818-	1564.61	2220.15	2456.24
		24"(610mm)	HAG-2418-	1650.88	2371.96	2634.29
		30"(762mm)	HAG-3018-	1737.15	2523.77	2812.34
		36"(914mm)	HAG-3618-	1823.42	2675.58	2990.39
		42"(1067mm)	HAG-4218-	1909.69	2827.39	3168.44
		48"(1219mm)	HAG-4818-	1995.96	2979.20	3346.49
		54"(1372mm)	HAG-5418-	2082.23	3131.01	3524.54
		60"(1524mm)	HAG-6018-	2168.50	3282.82	3702.59
	20"(508mm)	12"(305mm)	HAG-1220-	\$1541.00	N/A	\$2432.63
		18"(457mm)	HAG-1820-	1627.27	N/A	2610.68
		24"(610mm)	HAG-2420-	1713.54	N/A	2788.73
		30"(762mm)	HAG-3020-	1799.81	N/A	2966.78
		36"(914mm)	HAG-3620-	1886.08	N/A	3144.83
		42"(1067mm)	HAG-4220-	1972.35	N/A	3322.88
		48"(1219mm)	HAG-4820-	2058.62	N/A	3500.93
		54"(1372mm)	HAG-5420-	2144.89	N/A	3678.98
		60"(1524mm)	HAG-6020-	2231.16	N/A	3857.03
	24"(610mm)	12"(305mm)	HAG-1224-	\$1666.32	N/A	\$2741.51
		18"(457mm)	HAG-1824-	1752.59	N/A	2919.56
		24"(610mm)	HAG-2424-	1838.86	N/A	3097.61
		30"(762mm)	HAG-3024-	1925.13	N/A	3275.66
		36"(914mm)	HAG-3624-	2011.40	N/A	3453.71
		42"(1067mm)	HAG-4224-	2097.67	N/A	3631.76
		48"(1219mm)	HAG-4824-	2183.94	N/A	3809.81
		54"(1372mm)	HAG-5424-	2270.21	N/A	3987.86
		60"(1524mm)	HAG-6024-	2356.48	N/A	4165.91

*Patterned Glass (SQ-CM Checks Mix, SQ-ER English Reeded and SQ-VM Vertical Moire) available on 12"(305mm) and 18"(457mm) high add-on panels only.

Swing Doors with Steel Top Cap

PLACES

	Actual Height	Width	Door Swing	Number	Laminate	
					A	B
Single Door — Laminate	82"(2083mm)	36"(914mm)	Left	HDS-3682-HL	\$5899.06	\$6249.77
		42"(1067mm)	Left	HDS-4282-HL	\$6505.06	\$6903.99

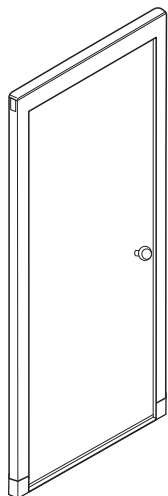

HDS-L

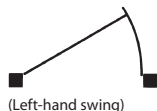

Features

- Includes complete panel assembly [hinge sets, carpet gripper, door jamb, side trim rails, leveling glides and trim, hollow core door (1.625"(41mm) thick), door hinges, hardware, brushed chrome knobs or ADA lever with lockset and keys, and threshold].
- Both sides of door covered in same laminate surface color.
- Door shipped with left-hand swing and can be field-changed for right-hand swing.
- 1"(25mm) deep top communications raceway.
- No power and communications in base raceway.

Specification Tips

- Door may be placed a maximum of 24"(610mm) from supporting panels at 90°.
- Will not accept add-on panel.

Door Opening Clearance

Door Size	Height	Width
3682	78"(1981mm)	28.75"(730mm)
4282	78"(1981mm)	34.75"(883mm)

To Order, Specify:

- 1) Product number.
- 2) Laminate surface color.
- 3) Trim color for raceway covers and glide housings.
- 4) Trim color for door jamb, top cap and side trim rails.

NOTES:

Some building codes may restrict the use of panel heights greater than 69"(1753mm). Consult your local code authority to assure that the furniture layout is compliant prior to installation.

Most building codes for new buildings require a minimum clear door width of 32"(813mm). To meet this requirement, the 42"(1067mm) door must be ordered.

Single Door — Glazed

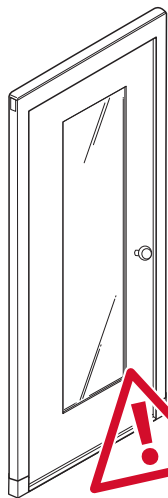

HDG-L
HDG-R

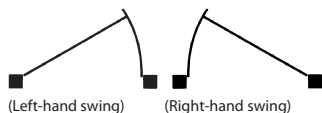

	Actual Height	Width	Number ①	Clear Laminate A	Laminate B	Frosted Laminate	
						A	B
Single Door — Glazed	82"(2083mm)	36"(914mm)	HDG-3682-H	\$6746.04	\$7083.25	\$7620.54	\$7957.75
		42"(1067mm)	HDG-4282-H	\$7171.69	\$7555.27	\$8046.19	\$8429.77

Features

- Includes complete panel assembly [hinge sets, carpet gripper, door jamb, side trim rails, leveling glides and trim, hollow core door (1.625"(41mm) thick), door hinges, hardware, brushed chrome knobs or ADA lever with lockset and keys, and threshold].
- Both sides of door covered in same laminate surface color.
- High-pressure laminate door surface.
- **Door swing not field changeable.**
- 1"(25mm) deep top communications raceway.
- No power and communications in base raceway.

Specification Tips

- Door may be placed a maximum of 24"(610mm) from supporting panels at 90°.
- Will not accept add-on panel.

Door Opening Clearance

Door Size	Height	Width
3682	78"(1981mm)	28.75"(730mm)
4282	78"(1981mm)	34.75"(883mm)

To Order, Specify:

- 1) Product number, including:
 - ① Door Swing
 - L Left-hand
 - R Right-hand
- 2) Glazing finish color.
- 3) Laminate surface color.
- 4) Trim color for raceway covers and glide housings.
- 5) Trim color for door jamb, top cap and side trim rails.

NOTES:

Some building codes may restrict the use of panel heights greater than 69"(1753mm). Consult your local code authority to assure that the furniture layout is compliant prior to installation.

Most building codes for new buildings require a minimum clear door width of 32"(813mm). To meet this requirement, the 42"(1067mm) door must be ordered.

OBSOLETE | March 2024

Panel Accessories

PLACES

90° Finish Post — for Steel Top Cap — Painted Surface

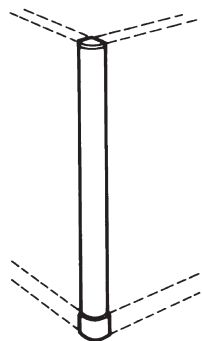

HDPC
Class BA

Actual Height	Width	Number	Price
30"(762mm)	2"(51mm)	HDPC-0030	\$191.09
37"(940mm)		HDPC-0037	216.64
44"(1118mm)		HDPC-0044	242.19
50"(1270mm)		HDPC-0050	264.09
56"(1422mm)		HDPC-0056	285.99
64"(1626mm)		HDPC-0064	315.19
68"(1727mm)		HDPC-0068	329.79
82"(2083mm)		HDPC-0082	380.89

Features

- Includes 90° painted vertical cover, plastic top cap and base raceway cover.
- Required by UL for covering base raceway flexible and straight-span power connectors when power connector covers are not used.

To Order, Specify:

- 1) Product number.
- 2) Painted surface color.
- 3) Trim color for raceway cover.
- 4) Trim color for top cap.

90° Power Connector Cover — Radius Profile

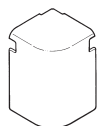

PCC-90-B
Class AA

4"(102mm)	PCC-90-B	\$118.35
-----------	----------	-----------------

Features

- Includes six (6) covers.
- Required by UL for covering flexible power connector in 90° panel configurations when finish post is not used.

To Order, Specify:

- 1) Product number.
- 2) Trim color.

Specification Tip

- For use with UniGroup and PLACES.

180° Finish Post — for Steel Top Cap — Painted Surface

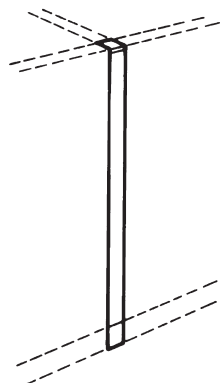

HDPS
Class BA

Actual Height	Width	Number	Price
30"(762mm)	2"(51mm)	HDPS-0030	\$213.63
37"(940mm)		HDPS-0037	226.23
44"(1118mm)		HDPS-0044	238.83
50"(1270mm)		HDPS-0050	249.63
56"(1422mm)		HDPS-0056	260.43
64"(1626mm)		HDPS-0064	274.83
68"(1727mm)		HDPS-0068	282.03
82"(2083mm)		HDPS-0082	307.23

Features

- Includes 180° painted vertical cover, plastic top cap and base raceway cover.
- Required by UL for covering base raceway flexible and straight-span power connectors when power connector covers are not used.

To Order, Specify:

- 1) Product number.
- 2) Painted surface trim color.
- 3) Trim color for raceway cover.
- 4) Trim color for top cap.

Panel Accessories

PLACES

	Actual Height	Number	Price
180° Power Connector Cover	4"(102mm)	PCC-180-B	\$118.35

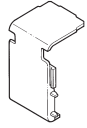

PCC-180-B
Class AA

Features

- Includes six (6) covers.
- Required by UL for covering straight-span or flexible power connectors in 180°, three-way panel configurations when finish post is not used.

To Order, Specify:

- 1) Product number.
- 2) Trim color.

Specification Tip

- For use with UniGroup Too, UniGroup and PLACES panels.

	Actual Height	Depth	Width	Number	Price
Steel Top Cap for 3-Way and 4-Way	0.44"(11mm)	2"(51mm)	2"(51mm)	HTF-0004	\$56.80

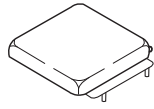

HTF-0004
Class BA

Features

- Includes one plastic top cap.
- Fills gap at intersection of three or four PLACES low profile steel top cap panels.

To Order, Specify:

- 1) Product number.
- 2) Trim color.

	Panel Height	Number	Price
Side Trim Rail With Notch	30"(762mm)	HRE-0030	\$137.18
	37"(940mm)	HRE-0037	148.66
	44"(1118mm)	HRE-0044	160.14
	50"(1270mm)	HRE-0050	169.98
	56"(1422mm)	HRE-0056	179.82
	64"(1626mm)	HRE-0064	192.94
	68"(1727mm)	HRE-0068	199.50
	82"(2083mm)	HRE-0082	222.46

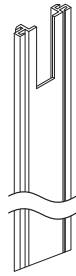

HRE
Class BA

Features

- Includes one notched side rail.
- Two side rails are included with each panel; order as replacement for base panel only.

To Order, Specify:

- 1) Product number.
- 2) Trim color.

Panel Bridge	2371-6401	\$21.92
---------------------	-----------	----------------

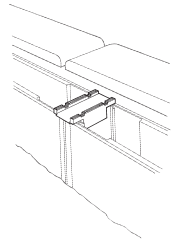

2371-6401
Class BA

Features

- Includes one panel bridge.
- Conceals top raceway between two top caps in a straight panel configuration.
- Applicable to PLACES 2"(51mm) thick panels only.
- For use with low profile steel top caps.

To Order, Specify:

- 1) Product number.
- 2) Trim color.

Panel Accessories

PLACES

	Height	Base Panel Height/Add-On	Number	Price
Full Height Side Trim Rail – for use with Add-On Panels	44"(1118mm)	30"(762mm)/14"(356mm)	HREH-3014	\$193.48
	50"(1270mm)	30"(762mm)/20"(508mm)	HREH-3020	208.72
	56"(1422mm)	44"(1118mm)/12"(305mm)	HREH-4412	223.96
	64"(1626mm)	44"(1118mm)/20"(508mm)	HREH-4420	244.28
	68"(1727mm)	44"(1118mm)/24"(610mm)	HREH-4424	254.44
	64"(1626mm)	50"(1270mm)/14"(356mm)	HREH-5014	244.28
	68"(1727mm)	50"(1270mm)/18"(457mm)	HREH-5018	254.44
	68"(1727mm)	56"(1422mm)/12"(305mm)	HREH-5612	254.44
	82"(2083mm)	64"(1626mm)/18"(457mm)	HREH-6418	290.00
	82"(2083mm)	68"(1727mm)/14"(356mm)	HREH-6814	290.00

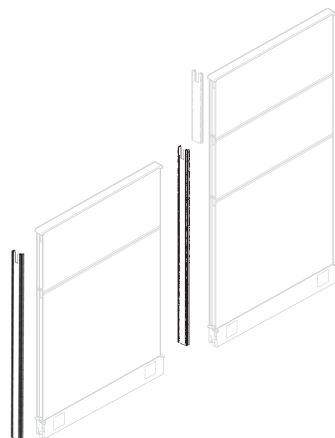

HREH

Feature

- Includes one full height side trim rail.

Specification Tips

- For use with base panel and one add-on panel.
- For two high add-on panel applications specify separately full-height side trim rail for base panel and one high add-on, for two high add-on panel location use side trim rail that ships with add-on panel. See Specification Guide for application guidelines.

To Order, Specify:

- 1) Product number.
- 2) Trim color.

	Panel Height	Width	Number	Price
Hinges	30"(762mm)	1.125"(29mm)	HHE-0030	\$26.06
	37"(940mm)		HHE-0037	26.06
	44"(1118mm)		HHE-0044	28.43
	50"(1270mm)		HHE-0050	30.80
	56"(1422mm)		HHE-0056	30.80
	64"(1626mm)		HHE-0064	33.17
	68"(1727mm)		HHE-0068	35.54
	82"(2083mm)		HHE-0082	45.02



HHE

Features

- Includes one hinge set for one side of trim rail.
- For replacement only (hinges are included with panels).
- One hinge set connects every two panels for angular connections.
- Two hinge sets are used for straight-line conditions.

To Order, Specify:

- 1) Product number.
- 2) Trim color.

Panel Accessories

for use with PLACES Panels

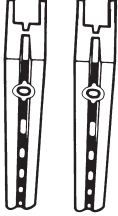
	Height	Depth	Width	Number	Price
	60"(1524mm)	0.75"(19mm)	0.625"(16mm)	WT-60	\$233.74
	72"(1829mm)			WT-72	274.42
	84"(213mm)			WT-84	315.10
<p>WT Class AA</p>					

Features

- Includes two wall tracks and mounting screws #10 2.5"(64mm) long.
- For attachment of components to structural walls.
- See installation instructions for proper mounting.

To Order, Specify:

- 1) Product number.
- 2) Trim color for track.

Specification Tip

- Not for use with up-mount overhead storage unit.

	Panel Height	Depth	Number	Price
	30"(762mm)	0.25"(6mm)	WMK-30	\$110.99
	35"(889mm) & 37"(940mm)		WMK-35	130.54
	42"(1067mm) & 44"(1118mm)		WMK-42	157.91
	48"(1219mm) & 50"(1219mm)		WMK-48	185.28
	56"(1422mm)		WMK-54	204.83
	62"(1575mm) & 64"(1626mm)		WMK-62	236.11
	66"(1676mm) & 68"(1727mm)		WMK-66	255.66
	80"(2032mm) & 82"(2083mm)		WMK-80	306.49
<p>WMK Class AA</p>				

Features

- Includes wall-mount channel, hinges and screws.
- For mounting panels, with or without add-on panel, to a structural wall.
- Adds 0.25"(6mm) to the panel width.

To Order, Specify:



- 1) Product number.
- 2) Trim color.

Specification Tip

- Must be properly anchored to a structural wall.

Panel Accessories

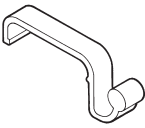
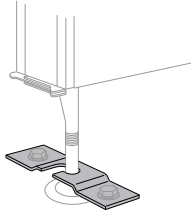
for use with PLACES Panels

	Actual Height	Depth	Width	Number	Price
All-Purpose Hook  HCH-0008	1"(25mm)	3"(76mm)	0.5"(13mm)	HCH-0008	\$231.98
Features <ul style="list-style-type: none"> • Includes eight hooks. • Attaches to PLACES steel top cap panels only. 		To Order, Specify: <ol style="list-style-type: none"> 1) Product number. 2) Trim color. 			
Seismic Anchoring Bracket  HAB				HAB-0001	\$333.05
Features <ul style="list-style-type: none"> • Includes package of six formed steel brackets. • For seismic anchoring of UniGroup Too, UniGroup and PLACES panels. 		To Order, Specify: <ol style="list-style-type: none"> 1) Product number. (No finish specification required.) 			
Friction Pad  7031-0501				7031-0501	\$18.94
Feature <ul style="list-style-type: none"> • Includes one pad. 		To Order, Specify: <ol style="list-style-type: none"> 1) Product number. (No finish specification required.) 			
Specification Tip <ul style="list-style-type: none"> • Attaches to bottom of glide to prevent movement of panels on hard surface flooring. 					

Panel Accessories – Retrofit Kits

for use with UniGroup Too and UniGroup Panels

	Width	Number	Trim A	B
Square Painted Top Caps For UniGroup Too and UniGroup Fabric and Laminate Panels, UniGroup Too Fabric Add-On Panels and Legacy UniGroup Videne Panels	12"(305mm)	E2TS-12-U	\$ 84.86	\$ 86.76
	18"(457mm)	E2TS-18-U	95.54	98.38
	24"(610mm)	E2TS-24-U	108.00	111.78
	30"(762mm)	E2TS-30-U	116.90	121.62
	36"(914mm)	E2TS-36-U	127.58	133.24
	42"(1067mm)	E2TS-42-U	138.26	144.86
	48"(1219mm)	E2TS-48-U	150.72	158.26
	54"(1372mm)	E2TS-54-U	159.62	168.10
	60"(1524mm)	E2TS-60-U	172.08	181.50



E2TS-U

Feature

- Includes square painted top cap, clips, aligner, and .6 end caps.

Specification Tips

- To be used with straight top cap panels only.
- Not to be used with UniGroup expanded top cap raceway.

To Order, Specify:

- Product number.
- Trim color.

Square Painted Top Caps For UniGroup Too and UniGroup Doors and Glazed Panels, UniGroup Open-Frame Panels, UniGroup Too Glazed Add-On Panels, and UniGroup Glazed and Fabric Add-On Panels	12"(305mm)	E2TS-12-T	\$ 84.86	\$ 86.76
	18"(457mm)	E2TS-18-T	95.54	98.38
	24"(610mm)	E2TS-24-T	108.00	111.78
	30"(762mm)	E2TS-30-T	116.90	121.62
	36"(914mm)	E2TS-36-T	127.58	133.24
	42"(1067mm)	E2TS-42-T	138.26	144.86
	48"(1219mm)	E2TS-48-T	150.72	158.26
	54"(1372mm)	E2TS-54-T	159.62	168.10
	60"(1524mm)	E2TS-60-T	172.08	181.50



E2TS-T

Feature

- Includes square painted top cap, clips, aligner, and .6 end caps.

Specification Tips

- To be used with straight top cap panels only.
- Not to be used with UniGroup expanded top cap raceway.
- Field modification of glazed panels and doors manufactured prior to September 2007 as required.

To Order, Specify:

- Product number.
- Trim color.

Trim Strip for UniGroup Fabric and Glazed Add-On Panels	12"(305mm)	E2UR-12-A	\$39.48	\$41.38
	18"(457mm)	E2UR-18-A	44.42	47.26
	24"(610mm)	E2UR-24-A	49.36	53.14
	30"(762mm)	E2UR-30-A	54.30	59.02
	36"(914mm)	E2UR-36-A	59.24	64.90
	42"(1067mm)	E2UR-42-A	64.18	70.78
	48"(1219mm)	E2UR-48-A	69.12	76.66
	54"(1372mm)	E2UR-54-A	74.06	82.54
	60"(1524mm)	E2UR-60-A	79.00	88.42

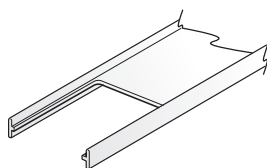

E2UR-A

Feature

- Includes trim strip.

Specification Tip

- Used to retrofit existing fabric and glazed add-on panels to match aesthetic appearance of UniGroup Too.

To Order, Specify:

- Product number.
- Trim color.

Panel Accessories – Retrofit Kits

for use with UniGroup Panels

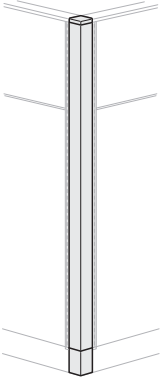
	Actual Height	Number	Trim A	B
90° Full-Height Finish Post — Square Painted Top Cap 	30"(762mm)	U2PC-28	\$160.68	\$176.44
	37"(940mm)	U2PC-35	172.86	191.28
	44"(1118mm)	U2PC-42	185.04	206.12
	50"(1270mm)	U2PC-48	195.48	218.84
	56"(1422mm)	U2PC-54	205.92	231.56
	64"(1626mm)	U2PC-62	219.84	248.52
	68"(1727mm)	U2PC-66	226.80	257.00
	82"(2083mm)	U2PC-80	251.16	286.68

U2PC

Feature

- Includes 90° vertical cover, square painted top cap and base raceway cover.

Specification Tips

- For use with equal height UniGroup panels in a 90°, 2-Way condition with UniGroup Too square painted top cap.
- To be used with straight top cap panels only.
- Required by UL for covering base raceway power connectors when power connector covers are not used.

To Order, Specify:

- Product number:
- Paint color for finish post.
- Trim color for raceway cover.
- Trim color for top cap.

Note: For mixed grade trim surfaces pricing will be determined by the sum of the upcharges. Please refer to the electronic catalog.

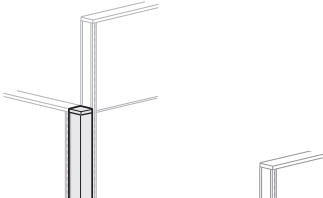
	Actual Height	Number	Trim A	B
90° Variable-Height Finish Post — Square Painted Top Cap 	30"(762mm)	U2PC-28-V	\$186.33	\$202.09
	37"(940mm)	U2PC-35-V	198.51	216.93
	44"(1118mm)	U2PC-42-V	210.69	231.77
	50"(1270mm)	U2PC-48-V	221.13	244.49
	56"(1422mm)	U2PC-54-V	231.57	257.21
	64"(1626mm)	U2PC-62-V	245.49	274.17
	68"(1727mm)	U2PC-66-V	252.45	282.65

U2PC-V

Feature

- Includes 90° vertical cover, square painted top cap and base raceway cover.

Specification Tips

- For use with multiple height UniGroup panels in a 90°, 2-Way condition; specify height to match lowest panel height with UniGroup Too square painted top cap.
- To be used with straight top cap panels only.
- Required by UL for covering base raceway power connectors when power connector covers are not used.

To Order, Specify:

- Product number:
- Paint color for finish post.
- Trim color for raceway cover.
- Trim color for top cap.

Note: For mixed grade trim surfaces pricing will be determined by the sum of the upcharges. Please refer to the electronic catalog.

Panel Accessories – Retrofit Kits

for use with UniGroup Panels

	Actual Height	Number	Trim A	B
120° Full-Height Finish Post — Square Painted Top Cap	30"(762mm)	U2PA-28	\$200.61	\$212.82
	37"(940mm)	U2PA-35	210.48	225.42
	44"(1118mm)	U2PA-42	220.35	238.02
	50"(1270mm)	U2PA-48	228.81	248.82
	56"(1422mm)	U2PA-54	237.27	259.62
	64"(1626mm)	U2PA-62	248.55	274.02
	68"(1727mm)	U2PA-66	254.19	281.22
	82"(2083mm)	U2PA-80	273.93	306.42

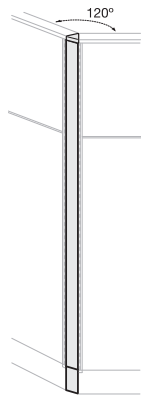

U2FA
U2PA

Feature

- Includes 120° vertical cover, square painted top cap and base raceway cover.

Specification Tips

- For use with equal height UniGroup panels in a 120°, 2-Way condition with UniGroup Too square painted top cap.
- To be used with straight top cap panels only.
- Required by UL for covering base raceway power connectors when power connector covers are not used.

To Order, Specify:

- Product number:
- Paint color for finish post.
- Trim color for raceway cover.
- Trim color for top cap.

Note: For mixed grade trim surfaces pricing will be determined by the sum of the upcharges. Please refer to the electronic catalog.

	Actual Height	Number	Trim A	B
120° Variable-Height Finish Post — Square Painted Top Cap	30"(762mm)	U2PA-28-V	\$226.06	\$238.27
	37"(940mm)	U2PA-35-V	235.93	250.87
	44"(1118mm)	U2PA-42-V	245.80	263.47
	50"(1270mm)	U2PA-48-V	254.26	274.27
	56"(1422mm)	U2PA-54-V	262.72	285.07
	64"(1626mm)	U2PA-62-V	274.00	299.47
	68"(1727mm)	U2PA-66-V	279.64	306.67

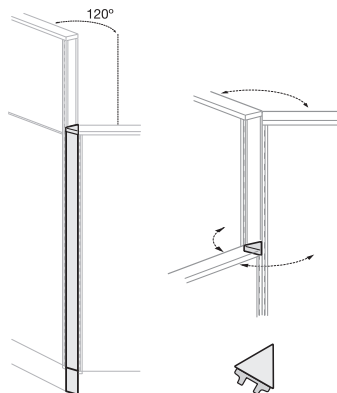

U2FA-V
U2PA-V

Feature

- Includes 120° vertical cover, square painted top cap and base raceway cover.

Specification Tips

- For use with multiple height UniGroup panels in a 120°, 2-Way condition; specify height to match lowest panel height with UniGroup Too square painted top cap.
- To be used with straight top cap panels only.
- Required by UL for covering base raceway power connectors when power connector covers are not used.

To Order, Specify:

- Product number:
- Paint color for finish post.
- Trim color for raceway cover.
- Trim color for top cap.

Note: For mixed grade trim surfaces pricing will be determined by the sum of the upcharges. Please refer to the electronic catalog.

Panel Accessories – Retrofit Kits

for use with UniGroup Panels

	Actual Height	Number	Trim A	B
180° Full-Height Finish Post — Square Painted Top Cap 	30"(762mm)	U2PS-28	\$157.58	\$173.38
	37"(940mm)	U2PS-35	170.38	189.38
	44"(1118mm)	U2PS-42	179.98	201.38
	50"(1270mm)	U2PS-48	189.58	213.38
	56"(1422mm)	U2PS-54	199.18	225.38
	64"(1626mm)	U2PS-62	211.98	241.38
	68"(1727mm)	U2PS-66	218.38	249.38
	82"(2083mm)	U2PS-80	240.78	277.38
Feature <ul style="list-style-type: none"> Includes 180° vertical cover, square painted top cap and base raceway cover. 		To Order, Specify: 1) Product number: 2) Paint color for finish post. 3) Trim color for raceway cover. 4) Trim color for top cap.		
Specification Tips <ul style="list-style-type: none"> For use with equal height UniGroup panels in a 180°, 3-Way condition with UniGroup Too square painted top cap. To be used with straight top cap panels only. Required by UL for covering base raceway power connectors when power connector covers are not used. 		Note: For mixed grade trim surfaces pricing will be determined by the sum of the upcharges. Please refer to the electronic catalog.		

U2FS
U2PS

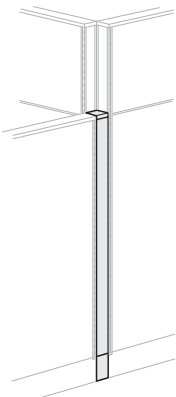
	Actual Height	Number	Trim A	B
180° Variable-Height Finish Post — Square Painted Top Cap 	30"(762mm)	U2PS-28-V1	\$183.03	\$198.83
		U2PS-28-V2I	183.03	198.83
		U2PS-28-V2L	183.03	198.83
	37"(940mm)	U2PS-35-V1	\$195.83	\$214.83
		U2PS-35-V2I	195.83	214.83
		U2PS-35-V2L	195.83	214.83
	44"(1118mm)	U2PS-42-V1	\$205.43	\$226.83
		U2PS-42-V2I	205.43	226.83
		U2PS-42-V2L	205.43	226.83
	50"(1270mm)	U2PS-48-V1	\$215.03	\$238.83
		U2PS-48-V2I	215.03	238.83
		U2PS-48-V2L	215.03	238.83
	56"(1422mm)	U2PS-54-V1	\$224.63	\$250.83
		U2PS-54-V2I	224.63	250.83
		U2PS-54-V2L	224.63	250.83
	64"(1626mm)	U2PS-62-V1	\$237.43	\$266.83
		U2PS-62-V2I	237.43	266.83
		U2PS-62-V2L	237.43	266.83
	68"(1727mm)	U2PS-66-V1	\$243.83	\$274.83
		U2PS-66-V2I	243.83	274.83
		U2PS-66-V2L	243.83	274.83
	82"(2083mm)	U2PS-80-V2I	\$266.23	\$302.83

U2FS-V
U2PS-V

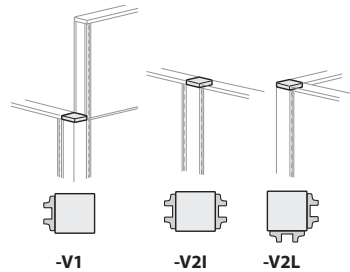

-V1

-V2I

-V2L

Features
 • Includes 180° vertical cover, square painted top cap and base raceway cover.
 • Includes top cap with one or two alignment tabs; specify accordingly.

Specification Tips
 • For use with multiple height UniGroup panels in a 180°, 3-Way condition with UniGroup Too square painted top cap; specify height to match lowest panel height except in V2I condition.
 • To be used with straight top cap panels only.
 • Product specification must reflect number of top cap alignment tabs for lowest like panel heights in an "I" or "L" condition; refer to UniGroup Too Application Guidelines.
 • Top cap alignment tabs are for dedicated applications and are not field removable; -V1, -V2I, -V2L.
 • Required by UL for covering base raceway power connectors when power connector covers are not used.

To Order, Specify:
 1) Product number:
 2) Paint color for finish post.
 3) Trim color for raceway cover.
 4) Trim color for top cap.

Note: For mixed grade trim surfaces pricing will be determined by the sum of the upcharges. Please refer to the electronic catalog.

Panel Accessories – Retrofit Kits

for use with PLACES Panels

	Width	Number	Trim A	B
Square Painted Top Caps For all PLACES doors and panel types except Legacy Gabled, Oblique and Expanded	12"(305mm)	E2TS-12-P	\$ 84.86	\$ 86.76
	18"(457mm)	E2TS-18-P	95.54	98.38
	24"(610mm)	E2TS-24-P	108.00	111.78
	30"(762mm)	E2TS-30-P	116.90	121.62
	36"(914mm)	E2TS-36-P	127.58	133.24
	42"(1067mm)	E2TS-42-P	138.26	144.86
	48"(1219mm)	E2TS-48-P	150.72	158.26
	54"(1372mm)	E2TS-54-P	159.62	168.10
	60"(1524mm)	E2TS-60-P	172.08	181.50



E2TS-P

Feature

- Includes square painted top cap, clips, aligner, and .6 end caps.

Specification Tips

- To be used with straight top cap panels only.
- Field modification of glazed panels and doors manufactured prior to September 2007 as required.

To Order, Specify:

- Product number.
- Trim color.

	Actual Height	Number	Trim A	B
90° Full-Height Finish Post — Square Painted Top Cap	30"(762mm)	H2PC-30	\$186.15	\$202.67
	37"(940mm)	H2PC-37	198.33	217.51
	44"(1118mm)	H2PC-44	210.51	232.35
	50"(1270mm)	H2PC-50	220.95	245.07
	56"(1422mm)	H2PC-56	231.39	257.79
	64"(1626mm)	H2PC-64	245.31	274.75
	68"(1727mm)	H2PC-68	252.27	283.23
	82"(2083mm)	H2PC-82	276.63	312.91

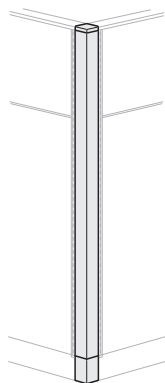

H2PC

Feature

- Includes 90° vertical cover, square painted top cap and base raceway cover.

Specification Tips

- For use with equal height PLACES panels in a 90°, 2-Way condition with UniGroup Too square painted top cap.
- Not for use with legacy expanded panels.
- To be used with straight top cap panels only.
- Required by UL for covering base raceway flexible and Straight power connectors when power connector covers are not used.

To Order, Specify:

- Product number:
- Paint color for finish post.
- Trim color for raceway cover.
- Trim color for top cap.

Note: For mixed grade trim surfaces pricing will be determined by the sum of the upcharges. Please refer to the electronic catalog.

	Actual Height	Number	Trim A	B
90° Variable-Height Finish Post — Square Painted Top Cap	30"(762mm)	H2PC-30-V	\$211.80	\$228.32
	37"(940mm)	H2PC-37-V	223.98	243.16
	44"(1118mm)	H2PC-44-V	236.16	258.00
	50"(1270mm)	H2PC-50-V	246.60	270.72
	56"(1422mm)	H2PC-56-V	257.04	283.44
	64"(1626mm)	H2PC-64-V	270.96	300.40
	68"(1727mm)	H2PC-68-V	277.92	308.88

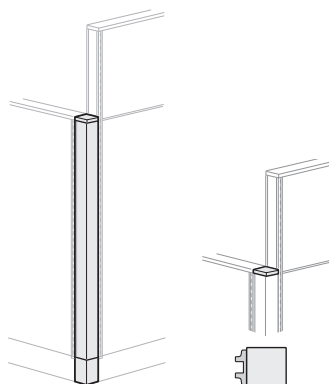

H2PC-V

Feature

- Includes 90° vertical cover, square painted top cap and base raceway cover.

Specification Tips

- For use with multiple height PLACES panels in a 90°, 2-Way condition; specify height to match lowest panel height with UniGroup Too square painted top cap.
- Not for use with legacy expanded panels.
- To be used with straight top cap panels only.
- Required by UL for covering base raceway power connectors when power connector covers are not used.

To Order, Specify:

- Product number:
- Paint color for finish post.
- Trim color for raceway cover.
- Trim color for top cap.

Note: For mixed grade trim surfaces pricing will be determined by the sum of the upcharges. Please refer to the electronic catalog.

Panel Accessories – Retrofit Kits

for use with PLACES Panels

	Actual Height	Number	Trim A	B
180° Full-Height Finish Post — Square Painted Top Cap 	30"(762mm)	H2PS-30	\$173.57	\$190.17
	37"(940mm)	H2PS-37	186.37	206.17
	44"(1118mm)	H2PS-44	195.97	218.17
	50"(1270mm)	H2PS-50	205.57	230.17
	56"(1422mm)	H2PS-56	215.17	242.17
	64"(1626mm)	H2PS-64	227.97	258.17
	68"(1727mm)	H2PS-68	234.37	266.17
	82"(2083mm)	H2PS-82	256.77	294.17

H2PS

Feature

- Includes 180° vertical cover, top cap and base raceway cover.

Specification Tips

- For use with equal height PLACES panels in a 180°, 3-Way condition with UniGroup Too square painted top cap.
- Not for use with legacy expanded panels.
- To be used with straight top cap panels only.
- Required by UL for covering base raceway power connectors when power connector covers are not used.

To Order, Specify:

- Product number:
- Paint color for finish post.
- Trim color for raceway cover.
- Trim color for top cap.

Note: For mixed grade trim surfaces pricing will be determined by the sum of the upcharges. Please refer to the electronic catalog.

180° Variable-Height Finish Post — Square Painted Top Cap

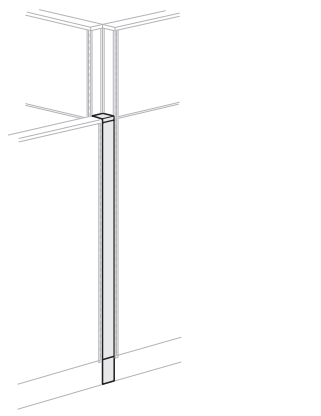

H2PS-V

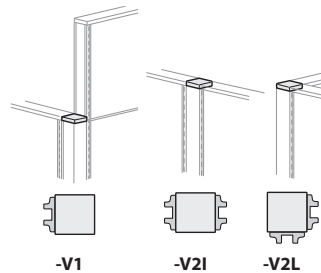

	Actual Height	Number	Trim A	B	
30"(762mm)		H2PS-30-V1	\$199.02	\$215.62	
		H2PS-30-V2I	199.02	215.62	
		H2PS-30-V2L	199.02	215.62	
	37"(940mm)		H2PS-37-V1	\$211.82	\$231.62
			H2PS-37-V2I	211.82	231.62
			H2PS-37-V2L	211.82	231.62
44"(1118mm)		H2PS-44-V1	\$221.42	\$243.62	
		H2PS-44-V2I	221.42	243.62	
		H2PS-44-V2L	221.42	243.62	
50"(1270mm)		H2PS-50-V1	\$231.02	\$255.62	
		H2PS-50-V2I	231.02	255.62	
		H2PS-50-V2L	231.02	255.62	
56"(1422mm)		H2PS-56-V1	\$240.62	\$267.62	
		H2PS-56-V2I	240.62	267.62	
		H2PS-56-V2L	240.62	267.62	
64"(1626mm)		H2PS-64-V1	\$253.42	\$283.62	
		H2PS-64-V2I	253.42	283.62	
		H2PS-64-V2L	253.42	283.62	
68"(1727mm)		H2PS-68-V1	\$259.82	\$291.62	
		H2PS-68-V2I	259.82	291.62	
		H2PS-68-V2L	259.82	291.62	
82"(2083mm)		H2PS-82-V2I	\$282.22	\$319.62	

Features

- Includes 180° vertical cover, square painted top cap and base raceway cover.
- Includes top cap with one or two alignment tabs; specify accordingly.

Specification Tips

- For use with multiple height PLACES panels in a 180°, 3-Way condition with UniGroup Too square painted top cap; specify height to match lowest panel height except in V2I condition.
- Not for use with legacy expanded panels.
- To be used with straight top cap panels only.
- Product specification must reflect number of top cap alignment tabs for lowest like panel heights in an "I" or "L" condition; refer to UniGroup Too Application Guidelines.
- Top cap alignment tabs are for dedicated applications and are not field removable; -V1, -V2I, -V2L.
- Required by UL for covering base raceway power connectors when power connector covers are not used.

To Order, Specify:

- Product number:
- Paint color for finish post.
- Trim color for raceway cover.
- Trim color for top cap.

Note: For mixed grade trim surfaces pricing will be determined by the sum of the upcharges. Please refer to the electronic catalog.

This page intentionally blank

Clerestory Kits

for use with UniGroup Too, UniGroup, PLACES

Clerestory Illustration

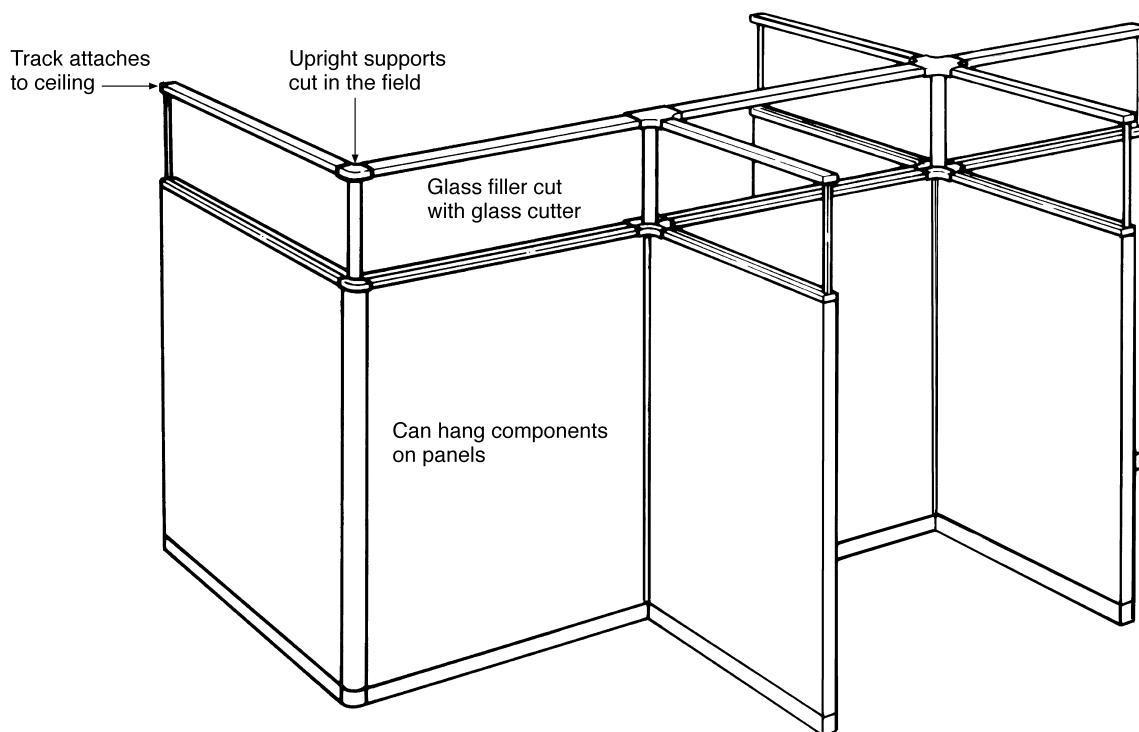

Planning and Specification

1. To determine how many lineal feet of straight track are needed, divide the total lineal feet of panels that require Clerestory by ten and round-off to the next highest whole number. Order that quantity of Straight Track SPCL-1616.
2. Examine your floor plan to determine the type and quantities of corner kits you will require. Note that only 90° angles are possible; other angles cannot be accommodated.
3. If mounting Clerestory on straight panel runs that include swing doors or glazed panels, a maximum combination of four lineal feet of glazed panels or glazed panels with a door is permitted per 12' (3658mm) panel run.
4. Follow normal support and load values for UniGroup Too, UniGroup and PLACES panels as defined in Haworth Installation Procedures.
5. Be sure that sprinkler, HVAC and lighting locations are taken into consideration when planning for Clerestory; it does form a floor-to-ceiling barrier.
6. Consult Installation Instructions #7021-6201 for specific installation information.

NOTES:

- Installation instructions available in the Library. Please refer to prior to ordering field supplied glass.
- Not to be used with top feed modules.
- Not to be used with sliding doors.
- Ceiling bracket designed to fit 1" (25mm) grid.
- **For UniGroup Too applications, 90° finish posts must be replaced with UniGroup 90° finish posts so radius aesthetic matches 2-way corner pieces. Field cut to size.**
- Installation of clerestory kits on PLACES panels will reduce the cabling capacity of the upper panel raceway and restrict access.

Code Compliance

Where Clerestory is used with UniGroup Too, UniGroup and PLACES panels that feature The Power Base electrical system, electrical components do not comply with UL 183 requirements for floor-to-ceiling partitions; the electrical components do comply with UL 1286 requirements for panel systems. Verify acceptance of this exception and check local codes.

Clerestory Kits

for use with UniGroup Too, UniGroup, PLACES

Application Guidelines

- Clerestory is designed to be used with 80"(2032mm) or 82"(2083mm) high UniGroup Too, UniGroup and PLACES panels where there is a maximum ceiling height of 10'(3048mm), OR with 64"(1626mm) or 68"(1727mm)-high panels where there is a maximum ceiling height of 9'(2743mm). Be sure that Clerestory complies with local building codes before ordering and installing the product.
- All aluminum and plastic components (such as corner moldings) are available color-matched to UniGroup Too, UniGroup and PLACES panel trim colors. **Not available in Metallic finishes.**
- Note: Laminated safety glass is required for use in all Clerestory applications; consult installation instructions glass specification directions (purchase all required glass locally).
- Minimum thickness of glass is 0.220"(6mm).
- Maximum thickness of glass is 0.275"(7mm).
- Glass panes should not exceed 5'(1524mm) in width.

Straight Track Kit

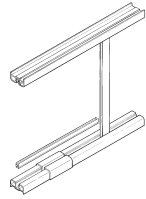

SPCL-1616

Number

SPCL-1616

Price

\$1045.26

Features

- Includes two 10'(3048mm) lengths of extruded aluminum, painted ceiling and panel track; two (2) 10'(3048mm) lengths of "H" spacer; extruded aluminum, painted vertical connectors; four (4) couplers; and hardware.
- To determine the amount of lineal feet of straight track needed, divide the total lineal feet of panels that require Clerestory by 10 and round off to the next highest whole number. Order that quantity of straight track.

To Order, Specify:

- 1) Product number.
- 2) Trim color.

2-Way Connector Kit

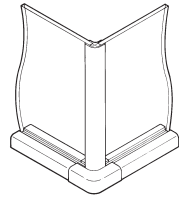

SPCL-1613

SPCL-1613

Vertical

\$163.14

Features

- Includes one 4'(1219mm) length of connector post and corner moldings for panel and ceiling.

Specification Tip

- Use with UniGroup or PLACES 90° finish posts only.

To Order, Specify:

- 1) Product number.
- 2) Trim color.

3-Way Connector Kit

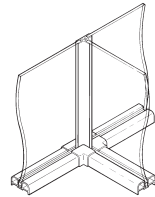

SPCL-1614

SPCL-1614

Vertical

\$177.24

Features

- Includes one 4'(1219mm) length of connector post and corner moldings for panel and ceiling.

To Order, Specify:

- 1) Product number.
- 2) Trim color.

4-Way Connector Kit

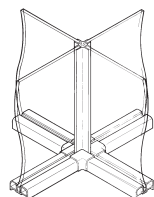

SPCL-1615

SPCL-1615

Vertical

\$195.36

Features

- Includes one 4'(1219mm) length of connector post and corner moldings for panel and ceiling.

To Order, Specify:

- 1) Product number.
- 2) Trim color.

End Kit

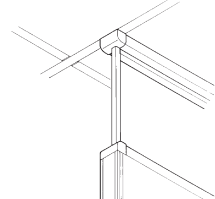

SPCL-1622

SPCL-1622

Vertical

\$98.69

Features



- Includes one 4'(1219mm) length of end trim post and panel end cap molding.

To Order, Specify:

- 1) Product number.
- 2) Trim color.

Electrical Components

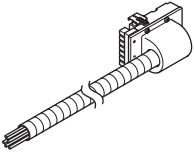
UniGroup Too, UniGroup, PLACES

	Description	Feed Length	Number	Price
Base Feed Module – Hardwire Connection  BFM-1-B BFM-1-B2 BFM-1-B4 	3-Circuit Hardwire 20 Amp			
		48"(1219mm)	BFM-1-B	\$ 431.54
		72"(1829mm)	BFM-0006-B	580.25
		120"(3048mm)	BFM-0010-B	752.47
		180"(4572mm)	BFM-0015-B	988.19
		300"(7620mm)	BFM-0025-B	1417.91
	4-Circuit, 2+2 Hardwire 20 Amp			
		48"(1219mm)	BFM-1-B2	\$ 431.54
		72"(1829mm)	BFM-0006-B2	580.25
		120"(3048mm)	BFM-0010-B2	752.47
		180"(4572mm)	BFM-0015-B2	988.19
		300"(7620mm)	BFM-0025-B2	1417.91
	4-Circuit, 3+1 Hardwire 20 Amp			
		48"(1219mm)	BFM-1-B4	\$ 431.54
		72"(1829mm)	BFM-0006-B4	580.25
		120"(3048mm)	BFM-0010-B4	752.47
	180"(4572mm)	BFM-0015-B4	988.19	
	300"(7620mm)	BFM-0025-B4	1417.91	

Features

- Includes one base feed with 4'(1219mm) long, with black 0.5"(13mm) flexible metal conduit.
- Conduit for 3-Circuit includes eight 12-gauge wires for up to three 20 amp circuits of power.
- Conduit for 4-Circuit includes six 12-gauge and two 10-gauge wires for up to four 20 amp circuits of power.
- For floor, column, or wall hardwire connections.
- For use with panels equipped with power components.
- Base feed module can be field modified to accommodate left or right conditions.
- Attaches at any one of the four receptacle sites in a powered base raceway of a panel.
- Standard in charcoal trim color only.

To Order, Specify:

- 1) Product number.
(No finish specification required.)

Specification Tips

- For use with UniGroup Too, UniGroup and PLACES.
- Not for use with power sources other than 120 volt 60 hertz.
- Do not mix 3-circuit with 4-circuit components. Do not mix 2+2 and 3+1 components. Components have unique polarity key and color coding (3-circuit=black, 6-circuit=ivory, 2+2=blue and 3+1=green).
- Application may require approval of local authority having jurisdiction (AHJ); ensure compliance before placing orders and installation.

Single Circuit Base Feed Module – Receptacle Connection with Power Cord  BFM-2-B BFM-2-B2 BFM-2-B4 	3-Circuit Cord Feed 20 Amp (USA Only)	2'(610mm)	BFM-2-B	\$407.34
	4-Circuit, 2+2 Cord Feed 20 Amp (USA Only)	2'(610mm)	BFM-2-B2	\$481.59
	4-Circuit, 3+1 Cord Feed 20 Amp (USA Only)	2'(610mm)	BFM-2-B4	\$481.59

Features

- Includes one base feed, 2'(610mm) cord and 20 amp plug (NEMA 5-20P).
- For use with panels equipped with power components.
- Requires a 20 amp, 125 volt power receptacle (NEMA 5-20R) for plug-in (not included).
- Provides power to circuit #1 only.
- Attaches at any of the four receptacle sites in a powered base raceway of a panel.
- Standard in charcoal trim color only.

To Order, Specify:

- 1) Product number.
(No finish specification required.)

Specification Tips

- For use with UniGroup Too, UniGroup and PLACES.
- **Not for use in Canada due to electrical code restrictions.**
- **Not for use with isolated ground receptacles.**
- Not for use with power sources other than 120 volt 60 hertz.
- Do not mix 3-circuit with 4-circuit components. Do not mix 2+2 and 3+1 components. Components have unique polarity key and color coding (3-circuit=black, 2+2=blue and 3+1=green).
- Application may require approval of local authority having jurisdiction (AHJ); ensure compliance before placing orders and installation.

Electrical Components

UniGroup Too, UniGroup, PLACES

	Description	Feed Length	Number	Price
Single Circuit Base Feed Module – Receptacle Connection with Power Cord	3-Circuit Cord Feed 15 Amp (Canada Only)	6'(1829mm)	BFM-2-A	\$390.62
	4-Circuit, 2+2 Cord Feed 15 Amp (Canada Only)	6'(1829mm)	BFM-2-A2	\$464.87
	4-Circuit, 3+1 Cord Feed 15 Amp (Canada Only)	6'(1829mm)	BFM-2-A4	\$464.87

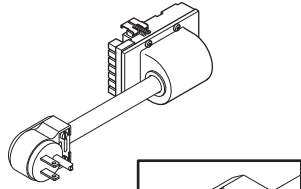

BFM-2-A
BFM-2-A2
BFM-2-A4

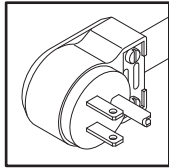

Features

- Includes one base feed, 6'(1829mm) cord, and 15 amp plug (NEMA 5-15P).
- For use with panels equipped with power components.
- Requires a 15 amp, 125 volt power receptacle (NEMA 5-15R) for plug-in (not included).
- Attaches at any one of four receptacle sites in a powered raceway of a panel.
- Provides power to circuit #1 only.
- Standard in charcoal trim color only.

To Order, Specify:

- 1) Product number.
(No finish specification required.)

Specification Tips

- For use with UniGroup Too, UniGroup and PLACES.
- **Not for use in USA due to electrical code restrictions.**
- **Not for use with isolated ground receptacles.**
- Not for use with power sources other than 120 volt 60 hertz.
- Do not mix 3-circuit with 4-circuit components. Do not mix 2+2 and 3+1 components. Components have unique polarity key and color coding (3-circuit=black, 2+2=blue and 3+1=green).
- Application may require approval of local authority having jurisdiction (AHJ); ensure compliance before placing orders and installation.

Electrical Components

UniGroup Too, UniGroup, PLACES

	Description	Number	Price
Base Feed Module — Concealed Hardwire Connection	3-Circuit Concealed	BFM-6-B	\$438.76
	4-Circuit, 2+2 Concealed	BFM-6-B2	\$869.79
	4-Circuit, 3+1 Concealed	BFM-6-B4	\$869.79

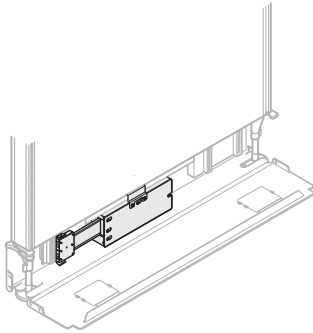

BFM-6-B
BFM-6-B2
BFM-6-B4



Features

- Includes one junction box with modular connector and three 0.5"(13mm) knockouts.
- For use with panels equipped with power components.
- For floor, column, or wall hardwire connections.
- For 3-Circuit includes eight 12-gauge wires for up to three 20 amp circuits of power.
- For 4-Circuit includes six 12-gauge and two 10-gauge wires for up to four 20 amp circuits of power.
- Attaches into receptacle site on left side of panel.
- Conforms to New York City electrical code.
- Junction box has three 0.5"(13mm) knockouts.

To Order, Specify:

- 1) Product number.
(No finish specification required.)

Specification Tips

- For use with UniGroup Too, UniGroup and PLACES.
- For installation on panels **no less than** 30"(762mm) wide.
- Conduit and fittings for connection between building and junction box are supplied by local electricians.
- Do not mix 3-circuit with 4-circuit components. Do not mix 2+2 and 3+1 components. Components have unique polarity key and color coding (3-circuit=black, 2+2=blue and 3+1=green).
- Application may require approval of local authority having jurisdiction (AHJ); ensure compliance before placing orders and installation.

	Description	Feed Length	Number	Price
Raised Floor Base Feed Module	3-Circuit Infeed Connector	69"(1753mm)	EBEJ-0072-3WF	\$544.86
	4-Circuit, 2+2 Infeed Connector	69"(1753mm)	EBEJ-0072-2WF	\$544.86
	4-Circuit, 3+1 Infeed Connector	69"(1753mm)	EBEJ-0072-4WF	\$544.86

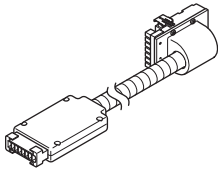

EBEJ-0072-3WF
EBEJ-0072-2WF
EBEJ-0072-4WF



Features

- Includes connector assembly which consists of one Power Base connector head, 0.5"(13mm) black flexible metal conduit and one Power Base AI connector and a two port splitter.
- Eight 12-gauge wires provided up to three 20-amp circuits for 3-circuit or four 20-amp circuits for 4-circuit power.
- For use with power components.
- Attaches at any one of the four receptacle sites in a powered base raceway of a panel and to a Power Base AI underfloor power system or a Power Base AI Wall feed.
- Base feed module can be field modified to accommodate left or right conditions.
- Connector has integral latching system.
- UL listed manufactured wiring system rated for 20-amp 120V/208Y or 120V/240V 60 Hz and for use in "other air handling spaces" per the NEC article 604.
- Standard in charcoal trim color only.

To Order, Specify:



- 1) Product number.
(No finish specification required.)

Specification Tips

- For use with UniGroup Too, UniGroup and PLACES.
- Male Power Base AI connector can plug directly into a zone distribution box, circuit distributor, flush floor box connectors or wall feed.
- Male Power Base AI connector cannot connect directly to infeed or jumper.
- Not for power sources other than 120 volt 60 hertz.
- Do not mix 3-circuit with 4-circuit components. Do not mix 2+2 and 3+1 components. Components have unique polarity key and color coding (3-circuit=black, 2+2=blue and 3+1=green).
- Application may require approval of local authority having jurisdiction (AHJ); ensure compliance before placing orders and installation.

Electrical Components

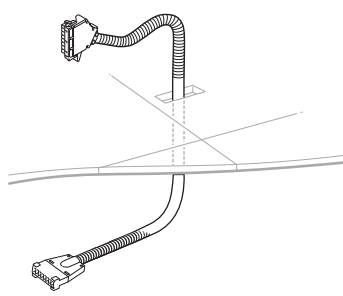
UniGroup Too, UniGroup, PLACES

	Description	Length	Number	Price
 <p>EVEJ-3WF EVEJ-2WF EVEJ-4WF</p> 	3-Circuit			
		64"(1626mm)	EUEJ-0064-3WF	\$276.75
		102"(2591mm)	EUEJ-0102-3WF	319.86
		144"(3658mm)	EUEJ-0144-3WF	384.57
		300"(7620mm)	EUEJ-0300-3WF	918.29
	4-Circuit, 2+2			
		64"(1626mm)	EUEJ-0064-2WF	\$303.70
		102"(2591mm)	EUEJ-0102-2WF	346.81
		144"(3658mm)	EUEJ-0144-2WF	411.52
		300"(7620mm)	EUEJ-0300-2WF	945.24
	4-Circuit, 3+1			
		64"(1626mm)	EUEJ-0064-4WF	\$303.70
	102"(2591mm)	EUEJ-0102-4WF	346.81	
	144"(3658mm)	EUEJ-0144-4WF	411.52	
	300"(7620mm)	EUEJ-0300-4WF	945.24	

Features

- Includes connector assembly which consists of one power base connector head, 0.5"(13mm) (unpainted) flexible metal conduit and one Power Base AI connector for up to three circuits of power and a two port splitter.
- Attaches at any one of the four receptacle sites in a powered base raceway of a panel and to a Power Base AI underfloor power system.

To Order, Specify:

- 1) Product number.
(No finish specification required.)

Specification Tips

- **Not for use with power sources other than 120 volt 60 hertz.**
- Male Power Base AI connector can plug directly into a zone distribution box, circuit distributor, flush floor box connectors or wall feed.
- Male Power Base AI connector cannot connect directly to infeed or jumper.
- Excess length can be coiled under the floor.
- Do not mix 3-circuit with 4-circuit components. Do not mix 2+2 and 3+1 components. Components have unique polarity key and color coding (3-circuit = black; 2+2 = blue; 3+1 = green).
- Application may require approval of local authority having jurisdiction (AHJ); ensure compliance before placing orders and installation.

**Wall Feed
Field Wired 1 Port**

	Description	Height	Length	Number	Price
 <p>FBEW</p> 	3-Circuit	1.5"(38mm)	4.69"(119mm)	FBEW-0004-31	\$113.32
	4-Circuit	1.5"(38mm)	4.69"(119mm)	FBEW-0004-41	\$113.32

Features

- Includes 4.69"(119mm) junction box cover with one female modular power connector.
- For use with field supplied 4.69"(119mm) square junction box.
- For use with Raised Floor Base Feed Module and Internal Power Base AI feed.
- Connector has integral latching system.
- UL listed manufactured wiring system rated for 20 AMP 120V/20BY or 120/240V 60 Hz and for use in other air.

To Order, Specify:

- 1) Product number.
(No finish specification required.)

Specification Tips

- Provides transition from building power to modular power distribution system. May be used with junction box in wall or column.
- Do not mix 3-circuit with 4-circuit. Do not mix 2+2 and 3+1 components. Components have unique polarity key and color coding (3-circuit=rust and 4-circuit=black).

Electrical Components

UniGroup Too, UniGroup and PLACES

	Description	Length	Number	Price
Infeed Harness	3-Circuit	15'(4572mm)	VEEH-0000-3	\$ 950.71
		30'(9144mm)	VEEH-0030-3	1457.09
	4-Circuit, 2+2	15'(4572mm)	VEEH-0000-2	\$ 950.71
		30'(9144mm)	VEEH-0030-2	1457.09
	4-Circuit, 3+1	15'(4572mm)	VEEH-0000-4	\$ 950.71
		30'(9144mm)	VEEH-0030-4	1457.09

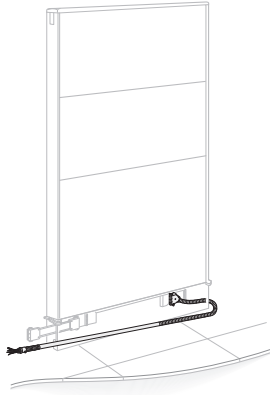

VEEH-3
VEEH-2
VEEH-4

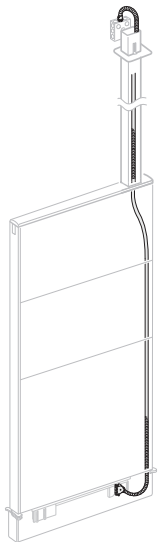

Features

- Includes electrical harness in metal conduit.
- For connection to the electrical source located in space above a drop ceiling or from floor.
- For use with panels equipped with power components.
- Electrical harness contained in metal conduit allows for adjacent routing of communication cabling within the pole.
- Conduit for 3-Circuit includes eight 12-gauge wires for up to three 20-amp circuits of power.
- Conduit for 4-Circuit includes six 12-gauge and two 10-gauge wires for up to four 20-amp circuits of power.
- Routes power to base raceway.
- Attaches to receptacle site on right hand side of panel in a powered raceway.

To Order, Specify:

- 1) Product number.
(No finish specification required.)

Specification Tips

- For use with UniGroup Too, UniGroup and PLACES.
- Not for use with power sources other than 120 volt 60 hertz.
- Do not mix 3-circuit with 4-circuit components. Do not mix 2+2 and 3+1 components. Components have unique polarity key and color coding (3-circuit=black, 2+2=blue and 3+1=green).
- Application may require approval of local authority having jurisdiction (AHJ); ensure compliance before placing orders and installation.

Electrical Components

UniGroup Too

**Top Feed Module —
UniGroup Too Only**

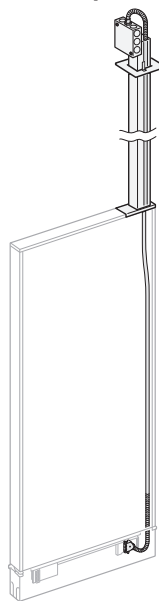

E2FM
E2FM-2
E2FM-4
E2FM-X



Description	Panel Height	Pole Length	Number	Trim A	B
10' Ceiling Height					
3-Circuit	32"(813mm) - 56"(1422mm)	124"(3150mm)	E2FM-3200-3	\$1963.09	\$2023.33
	64"(1626mm) - 80"(2032mm)	70"(1778mm)	E2FM-6400-3	1915.74	1943.04
4-Circuit, 2+2	32"(813mm) - 56"(1422mm)	124"(3150mm)	E2FM-3200-2	\$1963.09	\$2023.33
	64"(1626mm) - 80"(2032mm)	70"(1778mm)	E2FM-6400-2	1915.74	1943.04
4-Circuit, 3+1	32"(813mm) - 56"(1422mm)	124"(3150mm)	E2FM-3200-4	\$1963.09	\$2023.33
	64"(1626mm) - 80"(2032mm)	70"(1778mm)	E2FM-6400-4	1915.74	1943.04
12' Ceiling Height					
3-Circuit	40"(1016mm) - 80"(2032mm)	124"(3150mm)	E2FM-X	\$1963.09	\$2023.33
4-Circuit, 2+2	40"(1016mm) - 80"(2032mm)	124"(3150mm)	E2FM-X-2	\$1963.09	\$2023.33
4-Circuit, 3+1	40"(1016mm) - 80"(2032mm)	124"(3150mm)	E2FM-X-4	\$1963.09	\$2023.33

Features

- Includes one electrical harness in metal conduit, electrical box, ceiling bezel plate, single channel pole, hardware and square painted top cap cover.
- For connection to the electrical source located in space above a drop ceiling.
- For use with panels equipped with power components.
- Electrical harness contained in metal conduit allows for adjacent routing of communication cabling within the pole.
- Conduit for 3-Circuit includes eight 12-gauge wires for up to three 20-amp circuits of power.
- Conduit for 4-Circuit includes six 12-gauge and two 10-gauge wires for up to four 20-amp circuits of power.
- For routing and cabling capacities, see Specification Guide.
- Removable cover on pole provides access to pathway.
- Provides eight 12-gauge wires for up to three 20-amp circuits of power.
- Routes power to base raceway.
- Attaches at receptacle site on right hand side of panel in a powered base raceway.

To Order, Specify:

- 1) Product number.
- 2) Trim color for pole.
- 3) Trim color top cap piece.

Specification Tips

- For installation on panels no less than 18"(457mm) wide.
- Not for use with glazed add-on panels, glazed panels or single doors.
- For use with UniGroup Too square painted top cap panels only, field cutting of top cap is required.
- Not for use with power sources other than 120 volt 60 hertz.
- Do not mix 3-circuit with 4-circuit components. Do not mix 2+2 and 3+1 components. Components have unique polarity key and color coding (3-circuit=black, 2+2=blue and 3+1=green).
- Application may require approval of local authority having jurisdiction (AHJ); ensure compliance before placing orders and installation.

NOTE: Wire harness length is 180"(4572mm) regardless of pole length.

Electrical Components

UniGroup

	Description	Panel Height	Pole Length	Number	Price
Top Feed Module — UniGroup Only	10' Ceiling Height				
	3-Circuit	30"(762mm) - 56"(1422mm)	124"(3150mm)	TFM-3000-B	\$2257.01
		64"(1626mm) - 82"(2083mm)	70"(1778mm)	TFM-6400-B	2236.59
	4-Circuit, 2+2	30"(762mm) - 56"(1422mm)	124"(3150mm)	TFM-3000-B2	\$2257.01
		64"(1626mm) - 82"(2083mm)	70"(1778mm)	TFM-6400-B2	2236.59
	4-Circuit, 3+1	30"(762mm) - 56"(1422mm)	124"(3150mm)	TFM-3000-B4	\$2257.01
		64"(1626mm) - 82"(2083mm)	70"(1778mm)	TFM-6400-B4	2236.59
	12' Ceiling Height				
	3-Circuit	37"(940mm) - 82"(2083mm)	124"(3150mm)	TFM-X-B	\$2257.01
	4-Circuit, 2+2	37"(940mm) - 82"(2083mm)	124"(3150mm)	TFM-X-B2	\$2257.01
	4-Circuit, 3+1	37"(940mm) - 82"(2083mm)	124"(3150mm)	TFM-X-B4	\$2257.01

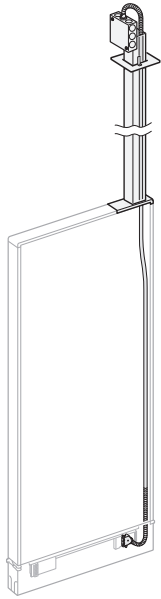

TFM-B
TFM-B2
TFM-B4
TFM-X



Features

- Includes one electrical harness in metal conduit, electrical box, ceiling bezel plate, single channel pole, hardware and radius top cap cover.
- For connection to the electrical source located in space above a drop ceiling.
- For use with panels equipped with power components.
- Electrical harness contained in metal conduit allows for adjacent routing of communication cabling within the pole.
- For routing and cabling capacities, see Specification Guide.
- Removable cover on poles provides access to pathway.
- Conduit for 3-Circuit includes eight 12-gauge wires for up to three 20-amp circuits of power.
- Conduit for 4-Circuit includes six 12-gauge and two 10-gauge wires for up to four 20-amp circuits of power.
- Routes power to base raceway.
- Attaches to receptacle site on right hand side of panel in a powered raceway.

To Order, Specify:

- 1) Product number.
- 2) Trim color for pole.
- 3) Trim color for top cap piece.

Specification Tips

- For installation on panels no less than 18"(457mm) wide.
- For use with UniGroup panels only.
- Not for use with glazed add-on panels, glazed and open frame panels or single doors.
- For use with UniGroup radius steel top cap, field cutting of top cap is required. When used with UniGroup radius wood top cap, access hole must be cut into top cap.
- Not for use with power sources other than 120 volt 60 hertz.
- Do not mix 3-circuit with 4-circuit components. Do not mix 2+2 and 3+1 components. Components have unique polarity key and color coding (3-circuit=black, 2+2=blue and 3+1=green).
- Application may require approval of local authority having jurisdiction (AHJ); ensure compliance before placing orders and installation.

NOTE: Wire harness length is 180"(4572mm) regardless of pole length.

PLACES — Electrical Components

PLACES

	Description	Panel Height	Pole Length	Number	Price
Top Feed Module — PLACES Only	10' Ceiling Height				
	3-Circuit	30"(762mm) - 56"(1422mm)	124"(3150mm)	HTFM-3000-3	\$2966.09
		64"(1626mm) - 82"(2083mm)	70"(1778mm)	HTFM-6400-3	2925.74
	4-Circuit, 2+2	30"(762mm) - 56"(1422mm)	124"(3150mm)	HTFM-3000-2	\$2966.09
		64"(1626mm) - 82"(2083mm)	70"(1778mm)	HTFM-6400-2	2925.74
	4-Circuit, 3+1	30"(762mm) - 56"(1422mm)	124"(3150mm)	HTFM-3000-4	\$2966.09
		64"(1626mm) - 82"(2083mm)	70"(1778mm)	HTFM-6400-4	2925.74
	12' Ceiling Height				
	3-Circuit	37"(940mm) - 82"(2083mm)	124"(3150mm)	HTFM-X	\$2966.09
	4-Circuit, 2+2	37"(940mm) - 82"(2083mm)	124"(3150mm)	HTFM-X-2	\$2966.09
4-Circuit, 3+1	37"(940mm) - 82"(2083mm)	124"(3150mm)	HTFM-X-4	\$2966.09	

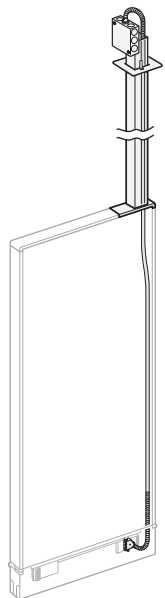

HTFM
HTFM-2
HTFM-4
HTFM-X



Features

- Includes electrical harness in metal conduit, electrical box, ceiling bezel plate, single channel pole, hardware and low profile top cap cover.
- For connection to the electrical source located in space above a drop ceiling.
- For use with panels equipped with power components.
- Electrical harness contained in metal conduit allows for adjacent routing of communication cabling within the pole.
- For routing and cabling capacities, see Specification Guide.
- Removable cover on poles provides access to pathway.
- Conduit for 3-Circuit includes eight 12-gauge wires for up to three 20-amp circuits of power.
- Conduit for 4-Circuit includes six 12-gauge and two 10-gauge wires for up to four 20-amp circuits of power.
- Routes power to base raceway.
- Attaches to receptacle site on right hand side of panel in a powered raceway.

To Order, Specify:

- 1) Product number.
- 2) Trim color for pole.
- 3) Trim color for top cap piece.

Specification Tips

- For installation on panels no less than 18"(457mm) wide.
- For use with PLACES panels only.
- Not for use with glazed add-on panels, glazed and open frame panels or single doors.
- For use with PLACES low profile steel top cap, field cutting of top cap is required. When used with PLACES low profile wood top cap, access hole must be cut into top cap.
- Not for use with power sources other than 120 volt 60 hertz.
- Do not mix 3-circuit with 4-circuit components. Do not mix 2+2 and 3+1 components. Components have unique polarity key and color coding (3-circuit=black, 2+2=blue and 3+1=green).
- Application may require approval of local authority having jurisdiction (AHJ); ensure compliance before placing orders and installation.

Plastic Liner — PLACES Only

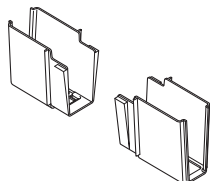

HCT-0000

	Number	Price
	HCT-0000	\$85.21

Features

- Includes a package of 10 plastic liners (enough for 5 panels).
- Used when routing communication cables in the top trough of PLACES.

To Order, Specify:

- 1) Product number.
(No finish specification required.)

Specification Tip

- Two liners per panel regardless of panel width.

Electrical Components

UniGroup Too, UniGroup, PLACES

	Description	Length	Number	Price
Flexible Power Connector — Panel-to-Panel	3-Circuit	8"(203mm)	PCF-3-B	\$239.10
	4-Circuit, 2+2	8"(203mm)	PCF-3-B2	\$239.10
	4-Circuit, 3+1	8"(203mm)	PCF-3-B4	\$239.10

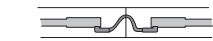
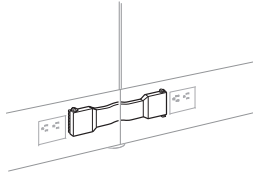

Base straight condition

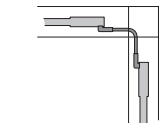
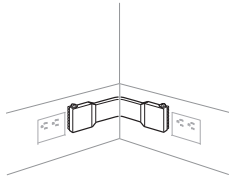

Panel outside 90° condition

PCF-3-B
PCF-3-B2
PCF-3-B4



Features

- Includes one flexible power connector with safety latches for securing connector to power block.
- Continues electrical circuit between adjacent powered panels in straight or angled conditions.
- Finish post or power connector cover is required by UL for covering flexible power connector.
- For use with panels equipped with power components.
- .95 Flexible Connectors shipped per powered panel specified.
- Standard in charcoal finish color only.

To Order, Specify:

- 1) Product number.
(No finish specification required.)

Specification Tips

- For use with UniGroup Too, UniGroup and PLACES.
- Not for use with power sources other than 120 volt 60 hertz.
- Do not mix 3-circuit with 4-circuit components. Do not mix 2+2 and 3+1 components. Components have unique polarity key and color coding (3-circuit=black, 2+2=blue and 3+1=green).

Electrical Components

UniGroup Too, UniGroup, PLACES

	Description	Length	Number	Price
Flexible Power Connector — Straight Span	3-Circuit	10.125"(257mm)	PCSS-3-B	\$201.39
	4-Circuit, 2+2	10.125"(257mm)	PCSS-3-B2	\$201.39
	4-Circuit, 3+1	10.125"(257mm)	PCSS-3-B4	\$201.39

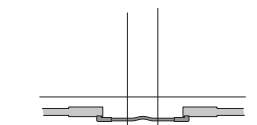
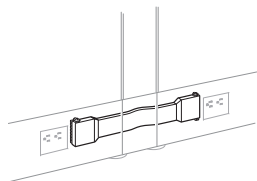

Panel three-way or four-way condition

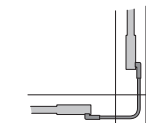
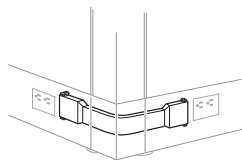

Panel outside 90° condition

PCSS-3-B
PCSS-3-B2
PCSS-3-B4



Features

- Includes one straight-span flexible power connector with safety latches for securing connector to power block.
- Continues electrical circuit across the 2" space between powered panels in a 3-way, 4-way or outside 90° condition in the base raceway.
- Retaining clips attached.
- For use with panels equipped with power components.
- Finish post or power connector cover is required by UL for covering straight-span power connector.
- Standard in charcoal finish color only.

To Order, Specify:

- 1) Product number.
(No finish specification required.)

Specification Tips

- For use with UniGroup Too, UniGroup and PLACES.
- Straight span flexible power connector must be separately specified and is not included with panel.
- Not for use with power sources other than 120 volt 60 hertz.
- Do not mix 3-circuit with 4-circuit components. Do not mix 2+2 and 3+1 components. Components have unique polarity key and color coding (3-circuit=black, 2+2=blue and 3+1=green).

Connector Assembly – 12" Pass-Through

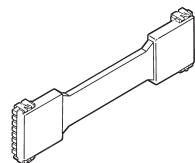

PCOF-1-B
PCOF-1-B2
PCOF-1-B4



Description	Length	Number	Price
3-Circuit	20"(508mm)	PCOF-1-B	\$217.50
4-Circuit, 2+2	20"(508mm)	PCOF-1-B2	\$217.50
4-Circuit, 3+1	20"(508mm)	PCOF-1-B4	\$217.50

Features

- Includes one flexible power connector with safety latches for securing connector to power block.
- Used to pass power through a 12"(305mm) wide panel and a 3-way or 4-way condition.
- Connector is provided with 12"(305mm) powered panel.
- For use with panels equipped with power components.

To Order, Specify:

- 1) Product number.
(No finish specification required.)

Specification Tips

- For use with UniGroup Too, UniGroup and PLACES.
- Designed for in line use only.
- Not for use with power sources other than 120 volt 60 hertz.
- Do not mix 3-circuit with 4-circuit components. Do not mix 2+2 and 3+1 components. Components have unique polarity key and color coding (3-circuit=black, 2+2=blue and 3+1=green).

Electrical Components

UniGroup Too, UniGroup, PLACES

Duplex Receptacle – 15 Amp

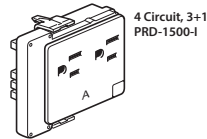
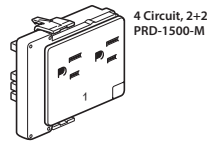
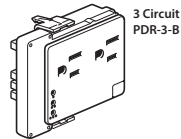
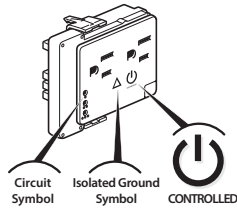

PRD-3-B
PRDI-5-B
PRD-1500-M
PRD-1500-I

Circuit Symbol	Circuit 1	Circuit 2	Circuit 3	Circuit 4
3 Circuit	0	00	000	NA
4 Circuit 2+2	1	2	3	4
4 Circuit 3+1	A	B	C	D

Description	Circuit Access	Receptacle Indicator	Ground Type	Receptacle without Controlled Symbol	Price	Receptacle with Controlled Symbol	Price
3-Circuit							
	Circuit 1-3	N/A	Common	PRD-3-B	\$254.29	PRD-3-BC	\$260.64
	Circuit 1-3	N/A	Isolated	PRDI-5-B	276.56	PRDI-5-BC	283.47
4-Circuit, 2+2							
	Circuit 1	1	Common	PRD-1500-M12	\$412.08	PRD-1500-M12C	\$422.39
	Circuit 2	2		PRD-1500-M22	412.08	PRD-1500-M22C	422.39
	Circuit 3	3		PRD-1500-M32	412.08	PRD-1500-M32C	422.39
	Circuit 4	4		PRD-1500-M42	412.08	PRD-1500-M42C	422.39
	Circuit 1	1	Isolated	PRD-1500-I12	\$434.35	PRD-1500-I12C	\$445.22
	Circuit 2	2		PRD-1500-I22	434.35	PRD-1500-I22C	445.22
	Circuit 3	3		PRD-1500-I32	434.35	PRD-1500-I32C	445.22
	Circuit 4	4		PRD-1500-I42	434.35	PRD-1500-I42C	445.22
4-Circuit, 3+1							
	Circuit 1	A	Common	PRD-1500-M14	\$412.08	PRD-1500-M14C	\$422.39
	Circuit 2	B		PRD-1500-M24	412.08	PRD-1500-M24C	422.39
	Circuit 3	C		PRD-1500-M34	412.08	PRD-1500-M34C	422.39
	Circuit 4	D		PRD-1500-M44	412.08	PRD-1500-M44C	422.39
	Circuit 1	A	Isolated	PRD-1500-I14	\$434.35	PRD-1500-I14C	\$445.22
	Circuit 2	B		PRD-1500-I24	434.35	PRD-1500-I24C	445.22
	Circuit 3	C		PRD-1500-I34	434.35	PRD-1500-I34C	445.22
	Circuit 4	D		PRD-1500-I44	434.35	PRD-1500-I44C	445.22

Features

- Includes box of six receptacles, each receptacle has two 15 Amp outlets (NEMA 5-15R configuration).
- For use with panels equipped with power components.
- Receptacles are ground type specific.**

Specification Tips

- Duplex for 3-Circuit are field programmable.
- Duplex for 4-Circuit have fixed circuit access and are not field programmable. Specify appropriate number of receptacles for each circuit.
- For power access at any location within the panels with appropriate base raceway covers.
- Not for use with power sources other than 120 volt 60 hertz.
- Isolated ground receptacle not for use with single circuit base feed module.
- Do not mix 3-circuit with 4-circuit components. Do not mix 2+2 and 3+1 components. Components have unique polarity key and color coding (3-circuit=black, 2+2=blue and 3+1=green).
- Controlled receptacles are marked with a permanent symbol and the word CONTROLLED to comply with various energy code requirements including ASHRAE 90.1 and California Building Code Title 24 part 6.**
- Circuit assignment and receptacle placement should be coordinated with a local electrician. Local electrician is responsible for circuit loading and code compliance.**
- Consult with local authority having jurisdiction (AHJ) for requirements regarding controlled receptacles before placing orders and installation.**



To Order, Specify:

- Product number.
- Trim color.

TR-R	Beige
TR-TY	Cement
TR-AK	Chalk
TR-K	Charcoal
TR-J	Graphite
TR-G	Gray Tone
TR-NG	Orange* Isolated ground only
TR-TW	Plaster
TR-AA	Putty
TR-E	Smoke

Electrical Components

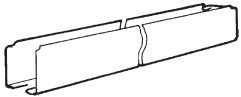
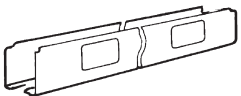
UniGroup Too, UniGroup, PLACES

	Actual Height	Panel Width	Number	Trim A	B
Raceway Retrofit Kit  RKN-B (Non-Powered)  RKP-B RKP-B2 (2+2 Powered) RKP-B4 (3+1 Powered) 	Non-Powered				
	4"(102mm)	18"(457mm)	RKN-18-B	\$220.89	\$230.51
		24"(610mm)	RKN-24-B	224.74	238.21
		30"(762mm)	RKN-30-B	228.59	245.91
		36"(914mm)	RKN-36-B	232.44	253.61
		42"(1067mm)	RKN-42-B	236.29	261.31
		48"(1219mm)	RKN-48-B	240.14	269.01
		54"(1372mm)	RKN-54-B	243.99	276.71
		60"(1524mm)	RKN-60-B	247.84	284.41
	3-Circuit				
	4"(102mm)	18"(457mm)	RKP-18-B	\$532.03	\$541.65
		24"(610mm)	RKP-24-B	535.88	549.35
		30"(762mm)	RKP-30-B	539.73	557.05
		36"(914mm)	RKP-36-B	543.58	564.75
		42"(1067mm)	RKP-42-B	547.43	572.45
	48"(1219mm)	RKP-48-B	551.28	580.15	
	54"(1372mm)	RKP-54-B	555.13	587.85	
	60"(1524mm)	RKP-60-B	558.98	595.55	
4-Circuit, 2+2					
4"(102mm)	18"(457mm)	RKP-18-B2	\$532.03	\$541.65	
	24"(610mm)	RKP-24-B2	535.88	549.35	
	30"(762mm)	RKP-30-B2	539.73	557.05	
	36"(914mm)	RKP-36-B2	543.58	564.75	
	42"(1067mm)	RKP-42-B2	547.43	572.45	
	48"(1219mm)	RKP-48-B2	551.28	580.15	
	54"(1372mm)	RKP-54-B2	555.13	587.85	
	60"(1524mm)	RKP-60-B2	558.98	595.55	
4-Circuit, 3+1					
4"(102mm)	18"(457mm)	RKP-18-B4	\$532.03	\$541.65	
	24"(610mm)	RKP-24-B4	535.88	549.35	
	30"(762mm)	RKP-30-B4	539.73	557.05	
	36"(914mm)	RKP-36-B4	543.58	564.75	
	42"(1067mm)	RKP-42-B4	547.43	572.45	
	48"(1219mm)	RKP-48-B4	551.28	580.15	
	54"(1372mm)	RKP-54-B4	555.13	587.85	
	60"(1524mm)	RKP-60-B4	558.98	595.55	

Features

- Powered retrofit kit includes one power distribution assembly, powered raceway cover, and flexible power connector.
- Convert powered panels to non-powered panels or non-powered panels to powered panels.
- Non-powered retrofit includes raceway cover retainer and non-powered raceway cover (no openings).

To Order, Specify:

- 1) Product number.
- 2) Trim color.

Specification Tips

- For use with UniGroup Too, UniGroup and PLACES.
- Do not mix 3-circuit with 4-circuit components. Do not mix 2+2 and 3+1 components. Components have unique polarity key and color coding (3-circuit=black, 2+2=blue and 3+1=green).

Electrical Components

UniGroup Too, UniGroup and PLACES

Duplex Receptacle – 20 Amp

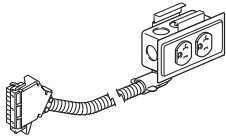

PRD-2000-M13
PRD-2000-M12



Description	Circuit Access	Ground Type	Number	Price
3-Circuit – 20 Amp Duplex	Circuit 1	Common	PRD-2000-M13	\$1048.01
	4-Circuit, 2+2 – 20 Amp Duplex			
Circuit 1	Common	PRD-2000-M12	\$1048.01	
4-Circuit, 3+1 – 20 Amp Duplex				
Circuit 1	Common	PRD-2000-M14	\$1048.01	

Features

- Includes one duplex receptacle assembly (outlets are NEMA 5-20R configuration) with mounting hardware.
- For use with panels 36”(914mm) wide and greater powered by power distribution assembly.
- Plugs into the receptacle location on the left side of the power distribution assembly.
- Receptacle and cover plate are black.

To Order, Specify:

- 1) Product number.
(No finish specification required.)

Specification Tips

- For use with UniGroup Too, UniGroup and PLACES.
- Receptacle is not circuit access programmable.
- Receptacle requires new raceway covers that must be ordered separately. Field modification of non-powered raceway covers are an alternate option.
- Standard powered raceway cover receptacle outlet locations are not compatible with this product.
- Panels powered by 3-circuit power distribution assemblies manufactured prior to January 2010 must order new power distribution assemblies based on panel size through e-parts.
- Do not mix 3-circuit with 4-circuit components. Do not mix 2+2 and 3+1 components. Components have unique polarity key and color coding (3-circuit = black, 2+2 = blue and 3+1 = green).
- Not for use in Canada.

Raceway Cover – 20 Amp

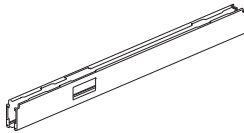

RKP-3-LS

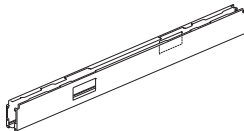

RKP-3-LB

	Panel Width	Number	Trim A	B
One Outlet/One Side				
	36”(914mm)	RKP-3-LS	\$562.80	\$583.97
	42”(1067mm)	RKP-42-LS	566.65	591.67
	48”(1219mm)	RKP-4-LS	570.50	599.37
	54”(1372mm)	RKP-54-LS	574.35	607.07
	60”(1524mm)	RKP-5-LS	578.20	614.77
One Outlet/Two Sides				
	36”(914mm)	RKP-3-LB	\$562.80	\$583.97
	42”(1067mm)	RKP-42-LB	566.65	591.67
	48”(1219mm)	RKP-4-LB	570.50	599.37
	54”(1372mm)	RKP-54-LB	574.35	607.07
	60”(1524mm)	RKP-5-LB	578.20	614.77

Features

- Includes raceway cover with receptacle openings available on one or two sides.
- For use with panels 36”(914mm) wide and greater powered by 3-Circuit power distribution assemblies manufactured after January 2010.
- For use with panels 36”(914mm) wide or greater powered by 4-Circuit power distribution assemblies.

To Order, Specify:

- 1) Product number.
- 2) Trim color.

Specification Tips

- For use with 20 Amp UniGroup Too, UniGroup and PLACES duplex receptacles only.
- Blank plates are not available for unused receptacle openings.
- Power Distribution Assembly (PDA) ordered separately.

Electrical Components

UniGroup Too, UniGroup, PLACES

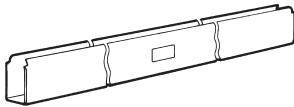
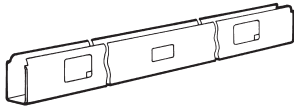
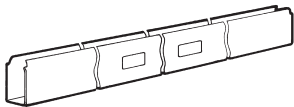
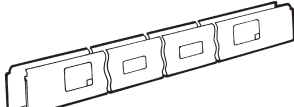
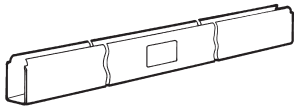
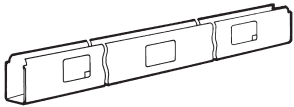
Description	Panel Width	Non-Powered Number	Trim A	Trim B	Powered Number	Trim A	Trim B
Ported Raceway Covers							
One Modular Furniture Telecommunications Opening, One Side							
 PRCN-B (Non-Powered Condition)	18"(457mm)	PRCN-1118-B	\$144.33	\$152.37	PRCP-1118-B	\$144.33	\$152.37
	24"(610mm)	PRCN-1124-B	154.37	166.41	PRCP-1124-B	154.37	166.41
	30"(762mm)	PRCN-1130-B	164.41	180.45	PRCP-1130-B	164.41	180.45
	36"(914mm)	PRCN-1136-B	174.45	194.49	PRCP-1136-B	174.45	194.49
	42"(1067mm)	PRCN-1142-B	184.49	208.53	PRCP-1142-B	184.49	208.53
	48"(1219mm)	PRCN-1148-B	194.53	222.57	PRCP-1148-B	194.53	222.57
	54"(1372mm)	PRCN-1154-B	204.57	236.61	PRCP-1154-B	204.57	236.61
60"(1524mm)	PRCN-1160-B	214.61	250.65	PRCP-1160-B	214.61	250.65	
One Modular Furniture Telecommunications Opening, Each Side							
 PRCP-B (Powered Condition)	18"(457mm)	PRCN-1218-B	\$164.39	\$172.43	PRCP-1218-B	\$164.39	\$172.43
	24"(610mm)	PRCN-1224-B	174.43	186.47	PRCP-1224-B	174.43	186.47
	30"(762mm)	PRCN-1230-B	184.47	200.51	PRCP-1230-B	184.47	200.51
	36"(914mm)	PRCN-1236-B	194.51	214.55	PRCP-1236-B	194.51	214.55
	42"(1067mm)	PRCN-1242-B	204.55	228.59	PRCP-1242-B	204.55	228.59
	48"(1219mm)	PRCN-1248-B	214.59	242.63	PRCP-1248-B	214.59	242.63
	54"(1372mm)	PRCN-1254-B	224.63	256.67	PRCP-1254-B	224.63	256.67
60"(1524mm)	PRCN-1260-B	234.67	270.71	PRCP-1260-B	234.67	270.71	
Two Modular Furniture Telecommunications Openings, One Side							
 PRCN-B (Non-Powered Condition)	30"(762mm)	PRCN-2130-B	\$184.47	\$200.51	PRCP-2130-B	\$184.47	\$200.51
	36"(914mm)	PRCN-2136-B	194.51	214.55	PRCP-2136-B	194.51	214.55
	42"(1067mm)	PRCN-2142-B	204.55	228.59	PRCP-2142-B	204.55	228.59
	48"(1219mm)	PRCN-2148-B	214.59	242.63	PRCP-2148-B	214.59	242.63
	54"(1372mm)	PRCN-2154-B	224.63	256.67	PRCP-2154-B	224.63	256.67
	60"(1524mm)	PRCN-2160-B	234.67	270.71	PRCP-2160-B	234.67	270.71
Two Modular Furniture Telecommunications Openings, Each Side							
 PRCP-B (Powered Condition)	30"(762mm)	PRCN-2230-B	\$204.52	\$220.56	PRCP-2230-B	\$204.52	\$220.56
	36"(914mm)	PRCN-2236-B	214.56	234.60	PRCP-2236-B	214.56	234.60
	42"(1067mm)	PRCN-2242-B	224.60	248.64	PRCP-2242-B	224.60	248.64
	48"(1219mm)	PRCN-2248-B	234.64	262.68	PRCP-2248-B	234.64	262.68
	54"(1372mm)	PRCN-2254-B	244.68	276.72	PRCP-2254-B	244.68	276.72
	60"(1524mm)	PRCN-2260-B	254.72	290.76	PRCP-2260-B	254.72	290.76
One Standard Wall Outlet Opening, One Side							
 PRCN-B (Non-Powered Condition)	42"(1067mm)	PRCN-0142-B	\$184.49	\$208.53	PRCP-0142-B	\$184.49	\$208.53
	48"(1219mm)	PRCN-0148-B	194.53	222.57	PRCP-0148-B	194.53	222.57
	60"(1524mm)	PRCN-0160-B	214.61	250.65	PRCP-0160-B	214.61	250.65
One Standard Wall Outlet Opening, Each Side							
 PRCP-B (Powered Condition)	42"(1067mm)	PRCN-0242-B	\$204.55	\$228.59	PRCP-0242-B	\$204.55	\$228.59
	48"(1219mm)	PRCN-0248-B	214.59	242.63	PRCP-0248-B	214.59	242.63
	60"(1524mm)	PRCN-0260-B	234.67	270.71	PRCP-0260-B	234.67	270.71

Features

- Retrofit to UniGroup Too, UniGroup and PLACES panel.
- Ported raceway covers enable communications equipment cabling to be routed to connector modules located on the faces of the base raceway covers. Six variations are available to accommodate the following connector modules: one modular furniture telecommunications opening centered on one side of the raceway cover; one modular furniture telecommunications opening centered on each side of the raceway cover; two modular furniture telecommunications openings on one side; two modular furniture telecommunications openings on each side; one standard wall outlet opening centered on one side; and one standard wall outlet opening centered on each side.
- Modular furniture telecommunications opening measures 1.38"(35mm) high x 2.7"(69mm) wide.
- Standard wall outlet opening measures 2.25"(57mm) high x 3.75"(95mm) wide.
- Openings for modular furniture telecommunications and standard wall outlets do not include covers.

To Order, Specify:

- 1) Product number.
- 2) Trim color.

Specification Tips

- Specify when no raceway cover is ordered (option -E).
- For use with UniGroup Too, UniGroup and PLACES.
- For use with 3-Circuit and 4-Circuit applications.

Electrical and Cable Management Accessories

End Cap / Communication Junction Box for use with UniGroup Too, UniGroup, PLACES

	Height	Number	Trim A	B
Base Raceway End Cap	4"(102mm)	EC-10-B	\$64.14	\$72.97
 <p>EC-10-B</p>	Features <ul style="list-style-type: none"> • Includes ten end caps. • For use at base raceway for end-of-run panel condition. 	To Order, Specify: <ol style="list-style-type: none"> 1) Product number. 2) Trim color. 		
	Note: .6 end caps included with every panel. Order additional as necessary.			

Electrical and Cable Management Accessories

UniGroup Too and UniGroup

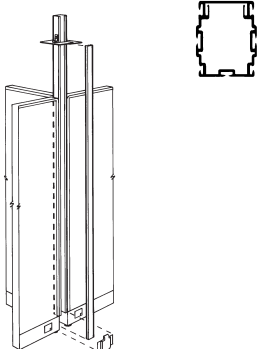
	Number	Trim A	B
<p>Cable Management Pole — One Channel – UniGroup Too and UniGroup Only</p>  <p>CMPF-1-BR</p>	<p>Number CMPF-1-BR</p> <p>Features</p> <ul style="list-style-type: none"> • Includes communications pole with cover, base raceway cover and ceiling bezel plate. • Interface with the base raceway cover. • Provides a means of vertically routing and accessing communications cabling within the panel's base raceway. • May also be used to route Top Feed Harness. • May be used in 2-way (in-line), 3-way or 4-way panel conditions. • Attaches to panel side trim rails. • For use up to 10'(3048mm) ceiling height. • Refer to Specification Guide for cable management. <p>Specification Tips</p> <ul style="list-style-type: none"> • Cannot be used in conjunction with finish posts. • For use with UniGroup Too and UniGroup. • For use with 3-Circuit and 4-Circuit applications. 	<p>\$920.12</p> <p>\$992.25</p>	<p>To Order, Specify:</p> <ol style="list-style-type: none"> 1) Product number. 2) Trim color for raceway cover. 3) Trim color for pole.

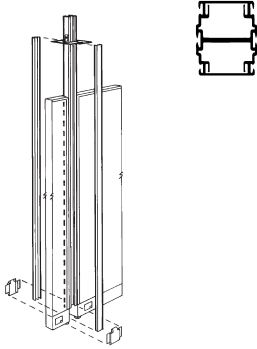
<p>Cable Management Pole — Two Channels – UniGroup Too and UniGroup Only</p>  <p>CMPT-1-B</p>	<p>Number CMPT-1-B</p> <p>Features</p> <ul style="list-style-type: none"> • Includes communications pole with covers, base raceway covers and ceiling bezel plate. • Provides cabling capacity with two integral channels. • May also be used to route Top Feed Harness. • May be used as a 2-way in-line panel filler. • Interior of 2"(51mm)-wide pole is separated by a metal divider, which separates communication cables in each compartment. • Attaches to panel side trim rails. • For use up to 10'(3048mm) ceiling height. <p>Specification Tips</p> <ul style="list-style-type: none"> • Use straight span connector to bypass electrical distribution. • Cannot be used in conjunction with finish posts. • For use with UniGroup Too and UniGroup. • For use with 3-Circuit and 4-Circuit applications. 	<p>\$1133.89</p> <p>\$1206.02</p>	<p>To Order, Specify:</p> <ol style="list-style-type: none"> 1) Product number. 2) Trim color for raceway cover. 3) Trim color for pole.
---	--	-----------------------------------	--

Electrical and Cable Management Accessories

PLACES

	Height	Width	Description	Number	Price	
Cable Management Pole – Panel Height – PLACES Only	44"(1118mm)	2"(51mm)	For 2-way 90° panel condition	HCPA-0044	\$952.57	
	50"(1270mm)			HCPA-0050	939.57	
	56"(1422mm)			HCPA-0056	926.66	
	64"(1626mm)			HCPA-0064	909.41	
	68"(1727mm)			HCPA-0068	900.74	
	82"(2083mm)			HCPA-0082	870.57	
		44"(1118mm)	2"(51mm)	For 3-way panel condition	HCPS-0044	\$952.57
		50"(1270mm)			HCPS-0050	939.57
		56"(1422mm)			HCPS-0056	926.66
		64"(1626mm)			HCPS-0064	909.41
	68"(1727mm)		HCPS-0068		900.74	
	82"(2083mm)		HCPS-0082		870.57	

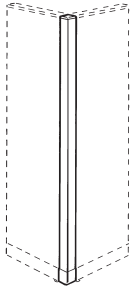

HCPA (2-Way)

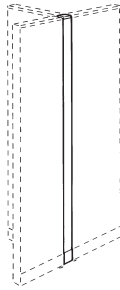

HCPS (3-Way)

Features

- Includes communications pole with cover, base raceway cover and top cap.
- Vertically routes communications cabling.
- Use in 2-way or 3-way panel conditions.
- In a 4-way condition, use cover as the fourth cable exit location.
- 10'(3048mm) ceiling height limit.
- Poles feature openings to match the panel's top raceway for continuous cable routing.
- Attaches to panel side trim rails.
- Refer to Specification Guide for cable management.

To Order, Specify:

- 1) Product number.
- 2) Trim color.
- 3) Trim color for raceway cover.

Specification Tips

- Cannot be used in conjunction with finish posts.
- For use with PLACES.
- For use with 3-Circuit and 4-Circuit applications.

Cable Management Pole – for 10'(3048mm)-High Ceiling – PLACES Only	44"(1118mm)	2"(51mm)	For 2-way 90° panel condition	HCPA-1044	\$979.17	
	50"(1270mm)			HCPA-1050	966.17	
	56"(1422mm)			HCPA-1056	953.26	
	64"(1626mm)			HCPA-1064	936.01	
	68"(1727mm)			HCPA-1068	927.34	
	82"(2083mm)			HCPA-1082	897.17	
		44"(1118mm)	2"(51mm)	For 3-way panel condition	HCPS-1044	\$979.17
		50"(1270mm)			HCPS-1050	966.17
		56"(1422mm)			HCPS-1056	953.26
		64"(1626mm)			HCPS-1064	936.01
	68"(1727mm)		HCPS-1068		927.34	
	82"(2083mm)		HCPS-1082		897.17	
	44"(1118mm)	2"(51mm)	For end-of-run panel condition	HCPE-1044	\$952.58	
	50"(1270mm)			HCPE-1050	939.58	
	56"(1422mm)			HCPE-1056	926.67	
	64"(1626mm)			HCPE-1064	909.42	
	68"(1727mm)			HCPE-1068	900.75	
	82"(2083mm)			HCPE-1082	870.58	

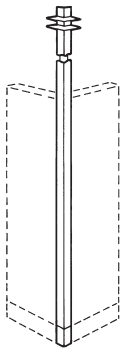

HCPA (2-Way)

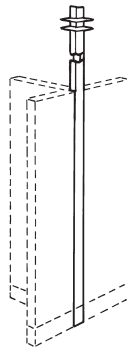

HCPS (3-Way)

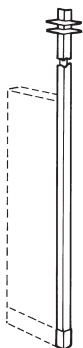

HCPE (End-of-run)

Features

- Includes communications pole with covers, base raceway covers and ceiling bezel plate.
- Vertically routes communications cabling.
- May also be used to route Top Feed Harness.
- Use in 2-way, 3-way, or end-of-run panel conditions (floor to ceiling only).
- In a 4-way condition, use cover as the fourth cable exit location.
- 10'(3048mm) ceiling height limit.
- Poles feature openings to match the panel's top raceway for continuous cable routing.
- Attaches to panel side trim rails.
- Refer to Specification Guide for cable management.

To Order, Specify:

- 1) Product number.
- 2) Trim color.
- 3) Trim color for raceway cover.

Specification Tips

- Cannot be used in conjunction with finish posts.
- For use with PLACES.
- For use with 3-Circuit and 4-Circuit applications.

Electrical and Cable Management Accessories

PLACES

	Height	Width	Description	Number	Price
Cable Management Pole – for 12' (3658mm)-High Ceiling – PLACES Only	44"(1118mm)	2"(51mm)	For 2-way 90° panel condition	HCPA-1244	\$1080.52
	50"(1270mm)			HCPA-1250	1067.52
	56"(1422mm)			HCPA-1256	1054.61
	64"(1626mm)			HCPA-1264	1037.36
	68"(1727mm)			HCPA-1268	1028.69
	82"(2083mm)			HCPA-1282	998.52
	44"(1118mm)	2"(51mm)	For 3-way panel condition	HCPS-1244	\$1080.52
	50"(1270mm)			HCPS-1250	1067.52
	56"(1422mm)			HCPS-1256	1054.61
	64"(1626mm)			HCPS-1264	1037.36
	68"(1727mm)			HCPS-1268	1028.69
	82"(2083mm)			HCPS-1282	998.52
	44"(1118mm)	2"(51mm)	For end-of-run panel condition	HCPE-1244	\$1053.93
	50"(1270mm)			HCPE-1250	1040.93
	56"(1422mm)			HCPE-1256	1028.02
	64"(1626mm)			HCPE-1264	1010.77
	68"(1727mm)			HCPE-1268	1002.10
	82"(2083mm)			HCPE-1282	971.93

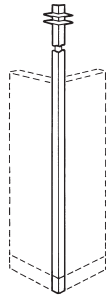

HCPA (2-Way)

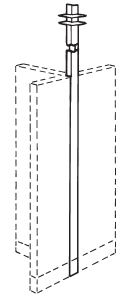

HCPS (3-Way)

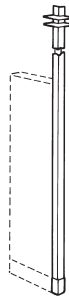

HCPE (End-of-run)

Features

- Includes communications pole with covers, base raceway covers and ceiling bezel plate.
- Vertically routes communications cabling.
- May also be used to route Top Feed Harness.
- Use in 2-way, 3-way, or end-of-run panel conditions (floor to ceiling only).
- In a 4-way condition, use cover as the fourth cable exit location.
- 12' (3658mm) ceiling height limit.
- Poles feature openings to match the panel's top raceway for continuous cable routing.
- Attaches to panel side trim rails.
- Refer to Specification Guide for cable management.

To Order, Specify:

- 1) Product number.
- 2) Trim color.
- 3) Trim color for raceway cover.

Specification Tips

- Cannot be used in conjunction with finish posts.
- For use with PLACES.
- For use with 3-Circuit and 4-Circuit applications.

Electrical and Cable Management Accessories

PLACES

	Height	Width	Number	Price
Cable Management Post – Variable Height – PLACES Only	24"(610mm)	2"(51mm)	HSCP-0024-V1	\$369.95
	52"(1321mm)		HSCP-0052-V1	534.88

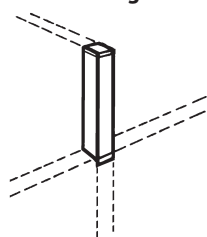

HSCP-V1

Features

- Includes post, low profile top cap and replacement low profile top cap for finish post.
- Available with fabric or painted surface.
- For three-way, 180° panel configurations.
- Use when taller panel meets lower panels in a straight-run condition and panel-top cable storage is required to continue along panel runs.
- Field cut to appropriate length.

To Order, Specify:

- 1) Product number.
- 2) Painted surface color.
- 3) Trim color.

Specification Tips

- For use with PLACES.
- For use with 3-Circuit and 4-Circuit applications.

Cable Management Post – Variable Height – Two-Way 90° – PLACES Only	24"(610mm)	2"(51mm)	HSCP-0024-V2	\$369.95
	52"(1321mm)		HSCP-0052-V2	534.88

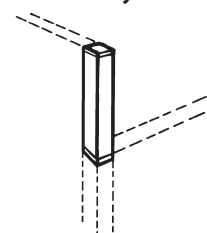

HSCP-V2

Features

- Includes post, low profile top cap and replacement low profile top cap for finish post.
- Available with fabric or painted surface.
- For 90° panel configuration applications only.
- Use when panels of two different heights meet and cable storage is required to continue along top of panel run.
- Field cut to appropriate length.

To Order, Specify:

- 1) Product number.
- 2) Painted surface color.
- 3) Trim color.

Specification Tips

- For use with PLACES.
- For use with 3-Circuit and 4-Circuit applications.

Cable Management Post – Variable Height — In-Line – PLACES Only	24"(610mm)	2"(51mm)	HSCP-0024-V3	\$369.95
	52"(1321mm)		HSCP-0052-V3	534.88

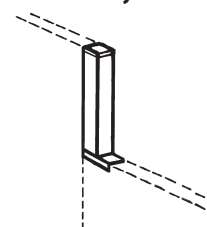

HSCP-V3

Features

- Includes post, low profile cap and lower panel end cap.
- Available with fabric or painted surface.
- For straight-line panel configurations.
- Use when panels of two different heights meet and panel-top cable storage is required to continue along panel run.
- Requires field modification of lower straight panel top cap.
- Field cut to appropriate length.

To Order, Specify:

- 1) Product number.
- 2) Painted surface color.
- 3) Trim color.

Specification Tips

- For use with PLACES.
- For use with 3-Circuit and 4-Circuit applications.

Electrical and Cable Management Accessories

PLACES

Height	Width	Number	Price
24"(610mm)	2"(51mm)	HCCP-0024-V4	\$447.74
52"(1321mm)		HCCP-0052-V4	612.67

Cable Management Post – Variable Height – Three-Way 90° – PLACES Only

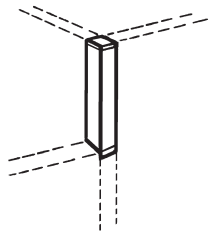

HCCP-V4
Class BA

Features

- Includes post, low profile top cap and replacement for low profile top cap finish post.
- Available with fabric or painted surface.
- For 90° panel configuration applications only.
- Use when equal-height panels at 90° meet lower-height panel and cable storage is required to continue along top of panel run.
- Field cut to appropriate length.

Specification Tips

- For use with PLACES.
- For use with 3-Circuit and 4-Circuit applications.

To Order, Specify:

- 1) Product number.
- 2) Fabric or painted surface color.
- 3) Trim color.

Power Breaker Marker

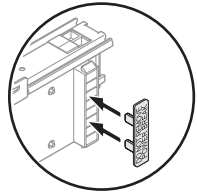

NEP-1
Class BC – SIN 33721;
Discount Group XI

Quantity	Number	Price
Fifty(50)	NEP-1	\$254.19

Features

- Use in pairs at adjoining power distribution assemblies in the flex connector sites to prevent improper electrical connections.
- Available in standard finish color only.

Specification Tip

- For use with UniGroup Too, UniGroup and PLACES.

To Order, Specify:

- 1) Product number.
(No finish specification required.)

Electrical and Cable Management Accessories

UniGroup

	Width	Number	Price
Expanded Top Cap Raceway – UniGroup Only	12"(305mm)	ETCR-12	\$184.12
	18"(457mm)	ETCR-18	198.30
	24"(610mm)	ETCR-24	212.48
	30"(762mm)	ETCR-30	226.66
	36"(914mm)	ETCR-36	240.84
	42"(1067mm)	ETCR-42	255.02
	48"(1219mm)	ETCR-48	269.20
	60"(1524mm)	ETCR-60	297.56

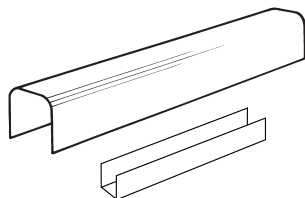

ETCR

Features

- Includes channel and top cap.
- Refer to specification guide for cable management.
- Replaces the panel's top cap and adds 2"(51mm) to the panel's height.
- For use with 3-Circuit and 4-Circuit applications.

To Order, Specify:

- 1) Product number.
- 2) Trim color.

Specification Tip

- For use with UniGroup.

	Description	Number	Price
Expanded Top Finish Cap – UniGroup Only	End-of-Run Cap	FC-1	\$ 70.23
	Two-Way	FC-2	54.75
	Three-Way	FC-3	81.86
	Four-Way	FC-4	105.10
	90° Corner	FC-90	68.31

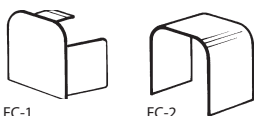

FC-1

FC-2

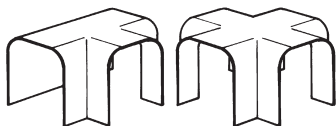

FC-3

FC-4

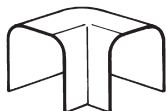

FC-90

Features

- Includes cover.
- Used to join expanded top caps in a panel run.
- Two-way cap is for straight connection over a straight finish post.
- Three-way cap is for connections of three panels.
- Four-way cap is for connections of four panels.
- 90° corner cap is for use in conjunction with a 90° finish post.
- End-of-run cap is used at an end-of-panel-run condition.
- For use with 3-Circuit and 4-Circuit applications.

To Order, Specify:

- 1) Product number.
- 2) Trim color.

Specification Tip

- For use with UniGroup.

UniGroup Too, UniGroup and PLACES Power Distribution for Hardwire Applications

Infeeds	Applications
1 Base Feed	48"(1219mm) or as required
2 Top Feed	Ceiling Height (H) + 18"(457mm)

Panel Applications	Panel Applications
3 Between two junction boxes on one panel	Panel Width (W) - 17"(432mm)
4 Between junction boxes if one per panel	Panel Width (W) - 8"(203mm)
5 Across panel-panel connection	9"(229mm)
6 Across 3- or 4-Way connection	11"(279mm)

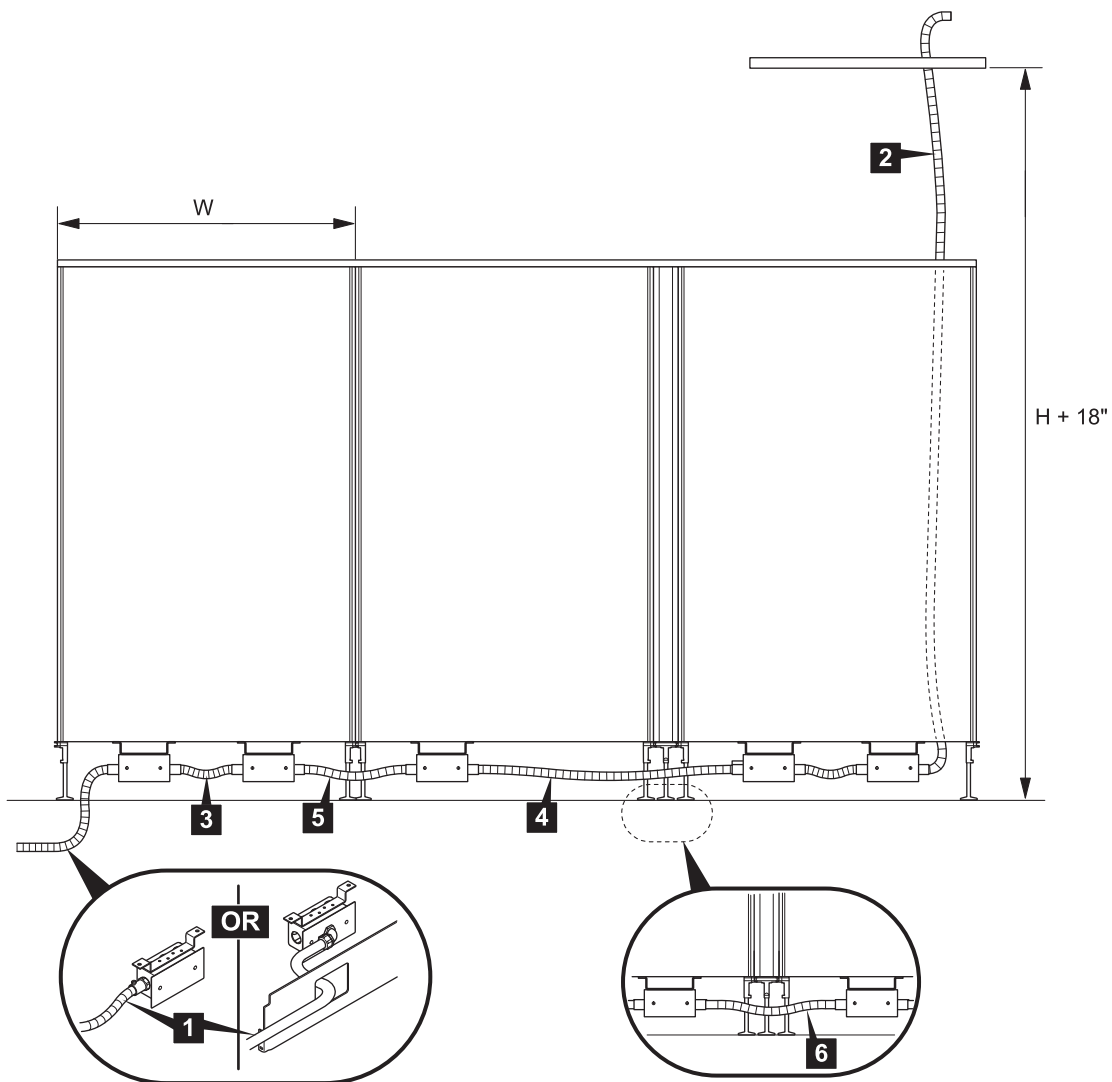

Electrical Components — Hardware

UniGroup Too, UniGroup, PLACES

	Number	Price
Base Feed Kit	BFM-1-C	\$242.97

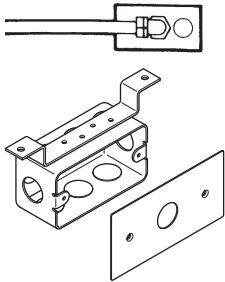

BFM-1-C



Features

- Includes one electrical box with 0.5”(13mm) knockouts, one base feed cover plate and panel mounting hardware.
- For panel hardwire infeed connections to floor, column or wall.

Specification Tips

- For use with UniGroup Too, UniGroup and PLACES.
- **Conduit, fittings, and receptacle are field supplied.**

To Order, Specify:

- 1) Product number.
- 2) Trim color (standard only).

	Number	Price
Dual Power Access Raceway Kit — 4”-High Base Raceway	RKP-00-C	\$456.92

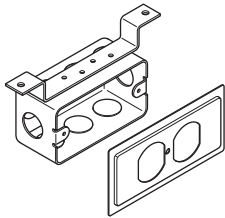

RKP-00-C



Height

4”(102mm)

Features

- Includes one electrical box with 0.5”(13mm) knockouts, one base feed cover plate, receptacle cover plate and panel mounting hardware.
- For hardwire receptacle access in panels.

Specification Tips

- Powered raceway cover ordered separately.
- Raceway cover requires field modification.
- For use with UniGroup Too, UniGroup and PLACES.
- **Conduit, fittings, and receptacle are field supplied.**

To Order, Specify:

- 1) Product number.
- 2) Trim color (standard only).

	Number	Price
Blank Cover Plate	BPM-1-C	\$70.47

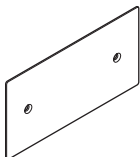

BPM-1-C

Features

- Includes one blank plate and hardware.
- For hardwire electrical box applications where no power access is required.

To Order, Specify:

- 1) Product number.
- 2) Trim color (standard only).

	Width	Number	Trim	
			A	B
	18”(457mm)	PRCP-0018-B	\$151.03	\$155.04
	24”(610mm)	PRCP-0024-B	165.13	171.11
	30”(762mm)	PRCP-0030-B	179.23	187.18
	36”(914mm)	PRCP-0036-B	193.33	203.25
	42”(1067mm)	PRCP-0042-B	207.43	219.32
	48”(1219mm)	PRCP-0048-B	221.53	235.39
	54”(1372mm)	PRCP-0054-B	235.63	251.46
	60”(1524mm)	PRCP-0060-B	249.73	267.53

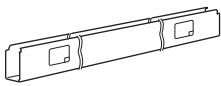

PRCP

Features

- Includes one raceway cover with openings for power.
- Retrofit to UniGroup Too, UniGroup and PLACES panel.

Specification Tips

- Specify when no raceway cover is ordered (option -E).
- For use with UniGroup Too, UniGroup and PLACES.
- Opening of raceway cover needs to be field modified for hardwire applications. See installation instructions.

To Order, Specify:

- 1) Product number.
- 2) Trim color.

Electrical Components — Hardwire / International

UniGroup Too and UniGroup

	Panel Height	Pole Length	Number	Trim A	B
Top Feed Module – Hardwire / International – UniGroup Too Only	32"(813mm) - 56"(1422mm)	124"(3150mm)	E2FM-3200-NT	\$622.80	\$683.04
	64"(1626mm) - 80"(2032mm)	70"(1778mm)	E2FM-6400-NT	575.45	602.75

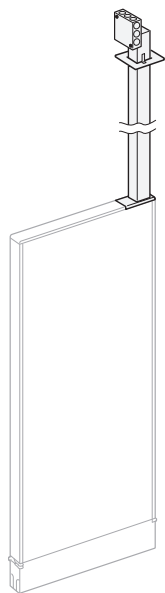

E2FM-NT
Class AC

Features

- Includes electrical box, ceiling bezel plate, single channel pole, hardware and square painted top cover.
- For connection to the electrical source located in space above a drop ceiling.
- For use with Chicago/Hardwire applications and with 4 meter Power Logic cord, ordered separately from Power Logic.
- For routing and cabling capacities, see Specification Guide.
- Removable cover on pole provides access to pathway.
- Routes power to base raceway.

To Order, Specify:

- 1) Product number.
- 2) Trim color for pole.
- 3) Trim color for top cap piece.

Specification Tips

- For installation on panels no less the 18"(457mm) wide.
- Not for use with glazed add-on panels, glazed panels or single doors.
- For use with UniGroup Too square painted top cap panels only, field cutting of top cap is required.
- Application may require approval of local authority having jurisdiction (AHJ); ensure compliance before placing orders and installation.

Top Feed Module – Hardwire / International – UniGroup Only	32"(813mm) - 56"(1422mm)	124"(3150mm)	TFM-3000-NT	\$608.73
	64"(1626mm) - 82"(2083mm)	70"(1778mm)	TFM-6400-NT	588.31

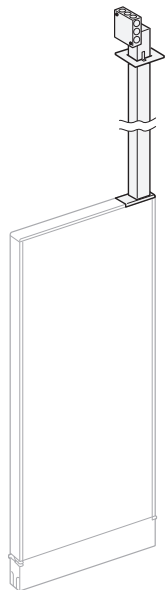

TFM-NT
Class AA

Features

- Includes electrical box, ceiling bezel plate, single channel pole, hardware and square painted top cover.
- For connection to the electrical source located in space above a drop ceiling.
- For use with Chicago/Hardwire applications and with 4 meter Power Logic cord, ordered separately from Power Logic.
- For routing and cabling capacities, see Specification Guide.
- Removable cover on pole provides access to pathway.
- Routes power to base raceway.

To Order, Specify:

- 1) Product number.
- 2) Trim color for pole.
- 3) Trim color for top cap piece.

Specification Tips

- For installation on panels no less the 18"(457mm) wide.
- Not for use with glazed add-on panels, glazed panels or single doors.
- For use with UniGroup radius steel top cap, field cutting of top cap is required. When used with UniGroup radius wood top cap, access hole must be cut into top cap.
- Application may require approval of local authority having jurisdiction (AHJ); ensure compliance before placing orders and installation.

Electrical Components — Hardwire / International

PLACES

	Panel Height	Pole Length	Number	Price
Top Feed Module – Hardwire / International – PLACES Only	10' Ceiling Height			
	30"(762mm) - 56"(1422mm)	124"(3150mm)	HTFM-3000-NT	\$758.16
	64"(1626mm) - 82"(2083mm)	70"(1778mm)	HTFM-6400-NT	717.81

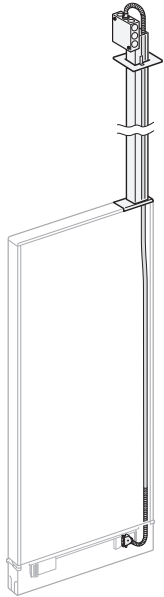

HTFM



Features

- Includes electrical box, ceiling bezel plate, single channel pole, hardware and low profile top cap cover.
- For connection to the electrical source located in space above a drop ceiling.
- For use with Chicago/Hardwire applications and with 4 meter Power Logic cord, ordered separately from Power Logic.
- For routing and cabling capacities, see Specification Guide.
- Removable cover on poles provides access to pathway.
- Routes power to base raceway.

To Order, Specify:

- 1) Product number.
- 2) Trim color for pole.
- 3) Trim color for top cap piece.

Specification Tips

- For installation on panels no less than 18"(457mm) wide.
- For use with PLACES panels only.
- Not for use with glazed add-on panels, glazed and open frame panels or single doors.
- For use with PLACES low profile steel top cap, field cutting of top cap is required. When used with PLACES low profile wood top cap, access hole must be cut into top cap.
- Application may require approval of local authority having jurisdiction (AHJ); ensure compliance before placing orders and installation.

Plastic Liner

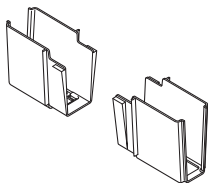

HCT-0000

Number	Price
HCT-0000	\$85.21

Features

- Includes a package of 10 plastic liners (enough for 5 panels).
- Used when routing communication cables in the top trough of PLACES.
- Two liners per panel regardless of panel width.

To Order, Specify:

- 1) Product number.
(No finish specification required.)

Electrical Components — International

UniGroup Too, UniGroup, PLACES

International Power Components

For power applications outside North America we recommend the use of **Power Logic** soft wiring components. Power Logic offers a system of single circuit power cords and receptacle modules that fit into our non-powered base raceway. Receptacle modules are offered with two sockets (3 and 4 socket versions also available). Each receptacle module has sockets, switches and fuses that are appropriate for each country around the world. Contact the Power Logic regional sales office in your area to help with planning details to assure local electrical code compliance. Contact Power Logic via the Haworth/Power Logic website, (www.haworth.com/powerlogic), or through their corporate offices in Cape Town, South Africa at 27-21-704-1450. Power Logic also offers power solutions for desktop, conference table or freestanding power applications.



Power Entry Cord



Cord

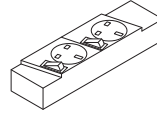

Receptacle



Splitter

Adaptable Worksurfaces

Rectangular

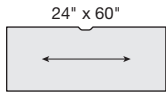

WURA

Features

- Includes work surface and tie plate.
- Laminate with 3mm edgeband (J) or knife edge (F) on user edge and 1mm edgeband on sides and back.
- Wood veneer work surface with 3mm edgeband (K) or knife (U) on user edge and 1mm edgeband on sides and back.
- Worksurfaces predrilled to accept most support options.
- Optional wireway along back edge of work surface is color-matched to solid side/back edge trim. When wood veneer or wood grain or patterned laminate is specified, wireway will be Charcoal. Refer to Specification Guide for wireway details.
- 24"(607mm)- to 60"(1524mm)-wide worksurfaces have one wireway.
- Worksurfaces wider than 60"(1524mm) have two wireways.
- **Installed worksurfaces without wireway will not allow clearance for power plug.**
- Depths and widths shown in nominal dimensions.
- Worksurfaces 36"(914mm) wide and above are drilled for pedestals.

Specification Tips

- **Work surface support specific to product line and work surface edge guidelines; must be separately specified; refer to Specification Guide for support and load.**
 - Standard cantilever brackets
 - Side/corner brackets
 - Work surface support panel
 - Support post or support column
 - Attached lower storage
 - P-Leg
- Knife edge requires use of work surface supports for that application; work surface support panel and/or side bracket for use with knife edge.
- Mini cantilever brackets are for use with 18"(457mm) deep worksurfaces with knife edge only.
- Intermediate support is required for unsupported work surface span greater than 60"(1524mm).

Note: Separately specified work surface reinforcement channels provide additional support for worksurfaces with 50"(1270mm) spans that are heavily loaded and not otherwise supported by mid-span cantilevers, work surface support panels, columns, legs or attached lower storage.

To Order, Specify:

1) Product number, including:

1 Surface Options:

- L** Laminate
- W** Wood

2 Edge Options:

Laminate:

- J** Edgeband

- F** Knife

Wood:

- K** Edgeband

- U** Knife

3 Wireway Options:

- A** Notched

- C** Without

2) Laminate surface color or Wood finish color.

3) Edge trim color (laminate only).

Adaptable Worksurfaces

Rectangular

Depth	Width	Number	①	②	③	Laminate A		Laminate B		Laminate E		Wood Group A		Wood Group B	
						J	F	J	F	J	F	K	U	K	U
18"(457mm)	24"(610mm)	WURA-1824-			S	\$ 297.40	\$ 493.45	\$ 320.74	\$ 516.79	\$ 389.03	\$ 585.08	\$ 684.21	\$ 948.64	\$ 725.84	\$ 990.27
	27"(686mm)	WURA-1827-			S	320.38	521.71	345.49	546.82	419.36	620.69	731.67	1005.48	775.82	1049.63
	30"(762mm)	WURA-1830-			S	344.20	553.45	371.08	580.33	450.53	659.78	779.13	1067.01	825.80	1113.68
	33"(838mm)	WURA-1833-			S	368.02	585.19	396.67	613.84	481.70	698.87	826.59	1128.54	875.78	1177.73
	36"(914mm)	WURA-1836-			S	391.84	616.93	422.26	647.35	512.87	737.96	874.05	1190.07	925.76	1241.78
	39"(991mm)	WURA-1839-			S	415.66	648.67	447.85	680.86	544.04	777.05	921.51	1251.60	975.74	1305.83
	42"(1067mm)	WURA-1842-			S	439.48	680.41	473.44	714.37	575.21	816.14	968.97	1313.13	1025.72	1369.88
	45"(1143mm)	WURA-1845-			S	463.30	712.15	499.03	747.88	606.38	855.23	1016.43	1374.66	1075.70	1433.93
	48"(1219mm)	WURA-1848-			S	540.42	797.19	577.92	834.69	690.85	947.62	1172.19	1544.49	1233.98	1606.28
	51"(1295mm)	WURA-1851-			S	564.24	828.93	603.51	868.20	722.02	986.71	1219.65	1606.02	1283.96	1670.33
	54"(1372mm)	WURA-1854-			S	588.06	860.67	629.10	901.71	753.19	1025.80	1267.11	1667.55	1333.94	1734.38
	57"(1448mm)	WURA-1857-			S	611.88	892.41	654.69	935.22	784.36	1064.89	1314.57	1729.08	1383.92	1798.43
	60"(1524mm)	WURA-1860-			S	635.70	924.15	680.28	968.73	815.53	1103.98	1362.03	1790.61	1433.90	1862.48
	63"(1600mm)	WURA-1863-			S	659.52	955.89	705.87	1002.24	846.70	1143.07	1409.49	1852.14	1483.88	1926.53
	66"(1676mm)	WURA-1866-			S	683.34	987.63	731.46	1035.75	877.87	1182.16	1456.95	1913.67	1533.86	1990.58
	69"(1753mm)	WURA-1869-			S	707.16	1019.37	757.05	1069.26	909.04	1221.25	1504.41	1975.20	1583.84	2054.63
	72"(1829mm)	WURA-1872-			S	730.98	1051.11	782.64	1102.77	940.21	1260.34	1551.87	2036.73	1633.82	2118.68
	75"(1905mm)	WURA-1875-			S	754.80	1082.85	808.23	1136.28	971.38	1299.43	1599.33	2098.26	1683.80	2182.73
	78"(1981mm)	WURA-1878-			S	778.62	1114.59	833.82	1169.79	1002.55	1338.52	1646.79	2159.79	1733.78	2246.78
	81"(2057mm)	WURA-1881-			S	802.44	1146.33	859.41	1203.30	1033.72	1377.61	1694.25	2221.32	1783.76	2310.83
	84"(2134mm)	WURA-1884-			S	826.26	1178.07	885.00	1236.81	1064.89	1416.70	1741.71	2282.85	1833.74	2374.88
	87"(2210mm)	WURA-1887-			S	850.08	1209.81	910.59	1270.32	1096.06	1455.79	1789.17	2344.38	1883.72	2438.93
	90"(2286mm)	WURA-1890-			S	873.90	1241.55	936.18	1303.83	1127.23	1494.88	1836.63	2405.91	1933.70	2502.98
	93"(2362mm)	WURA-1893-			S	897.72	1273.29	961.77	1337.34	1158.40	1533.97	1884.09	2467.44	1983.68	2567.03
	96"(2438mm)	WURA-1896-			S	921.54	1305.03	987.36	1370.85	1189.57	1573.06	1931.55	2528.97	2033.66	2631.08
	99"(2515mm)	WURA-1899-			S	945.36	1336.77	1012.95	1404.36	1220.74	1612.15	1979.01	2590.50	2083.64	2695.13
	102"(2591mm)	WURA-18A2-			S	969.18	1368.51	1038.54	1437.87	1251.91	1651.24	2026.47	2652.03	2133.62	2759.18
	105"(2667mm)	WURA-18A5-			S	993.00	1400.25	1064.13	1471.38	1283.08	1690.33	2073.93	2713.56	2183.60	2823.23
	108"(2743mm)	WURA-18A8-			S	1016.82	1431.99	1089.72	1504.89	1314.25	1729.42	2121.39	2775.09	2233.58	2887.28
	111"(2819mm)	WURA-18B1-			S	1040.64	1463.73	1115.31	1538.40	1345.42	1768.51	2168.85	2836.62	2283.56	2951.33
	114"(2890mm)	WURA-18B4-			S	1064.46	1495.47	1140.90	1571.91	1376.59	1807.60	2216.31	2898.15	2333.54	3015.38
	117"(2972mm)	WURA-18B7-			S	1088.28	1527.21	1166.49	1605.42	1407.76	1846.69	2263.77	2959.68	2383.52	3079.43
	120"(3048mm)	WURA-18C0-			S	1112.10	1558.95	1192.08	1638.93	1438.93	1885.78	2311.23	3021.21	2433.50	3143.48
24"(610mm)	24"(610mm)	WURA-2424-			S	\$ 339.03	\$ 543.27	\$ 362.37	\$ 566.61	\$ 430.66	\$ 634.90	\$ 750.83	\$1040.01	\$ 792.46	\$1081.64
	27"(686mm)	WURA-2427-			S	364.41	573.93	389.52	599.04	463.39	672.91	803.24	1101.80	847.39	1145.95
	30"(762mm)	WURA-2430-			S	390.63	608.07	417.51	634.95	496.96	714.40	855.65	1168.28	902.32	1214.95
	33"(838mm)	WURA-2433-			S	416.85	642.21	445.50	670.86	530.53	755.89	908.06	1234.76	957.25	1283.95
	36"(914mm)	WURA-2436-			S	443.07	676.35	473.49	706.77	564.10	797.38	960.47	1301.24	1012.18	1352.95
	39"(991mm)	WURA-2439-			S	469.29	710.49	501.48	742.68	597.67	838.87	1012.88	1367.72	1067.11	1421.95
	42"(1067mm)	WURA-2442-			S	495.51	744.63	529.47	778.59	631.24	880.36	1065.29	1434.20	1122.04	1490.95
	45"(1143mm)	WURA-2445-			S	521.73	778.77	557.46	814.50	664.81	921.85	1117.70	1500.68	1176.97	1559.95
	48"(1219mm)	WURA-2448-			S	601.25	866.21	638.75	903.71	751.68	1016.64	1278.41	1675.46	1340.20	1737.25
	51"(1295mm)	WURA-2451-			S	627.47	900.35	666.74	939.62	785.25	1058.13	1330.82	1741.94	1395.13	1806.25
	54"(1372mm)	WURA-2454-			S	653.69	934.49	694.73	975.53	818.82	1099.62	1383.23	1808.42	1450.06	1875.25
	57"(1448mm)	WURA-2457-			S	679.91	968.63	722.72	1011.44	852.39	1141.11	1435.64	1874.90	1504.99	1944.25
	60"(1524mm)	WURA-2460-			S	706.13	1002.77	750.71	1047.35	885.96	1182.60	1488.05	1941.38	1559.92	2013.25
	63"(1600mm)	WURA-2463-			S	732.35	1036.91	778.70	1083.26	919.53	1224.09	1540.46	2007.86	1614.85	2082.25
	66"(1676mm)	WURA-2466-			S	758.57	1071.05	806.69	1119.17	953.10	1265.58	1592.87	2074.34	1669.78	2151.25
	69"(1753mm)	WURA-2469-			S	784.79	1105.19	834.68	1155.08	986.67	1307.07	1645.28	2140.82	1724.71	2220.25
	72"(1829mm)	WURA-2472-			S	811.01	1139.33	862.67	1190.99	1020.24	1348.56	1697.69	2207.30	1779.64	2289.25
	75"(1905mm)	WURA-2475-			S	837.23	1173.47	890.66	1226.90	1053.81	1390.05	1750.10	2273.78	1834.57	2358.25
	78"(1981mm)	WURA-2478-			S	863.45	1207.61	918.65	1262.81	1087.38	1431.54	1802.51	2340.26	1889.50	2427.25
	81"(2057mm)	WURA-2481-			S	889.67	1241.75	946.64	1298.72	1120.95	1473.03	1854.92	2406.74	1944.43	2496.25
	84"(2134mm)	WURA-2484-			S	915.89	1275.89	974.63	1334.63	1154.52	1514.52	1907.33	2473.22	1999.36	2565.25
	87"(2210mm)	WURA-2487-			S	942.11	1310.03	1002.62	1370.54	1188.09	1556.01	1959.74	2539.70	2054.29	2634.25
	90"(2286mm)	WURA-2490-			S	968.33	1344.17	1030.61	1406.45	1221.66	1597.50	2012.15	2606.18	2109.22	2703.25
	93"(2362mm)	WURA-2493-			S	994.55	1378.31	1058.60	1442.36	1255.23	1638.99	2064.56	2672.66	2164.15	2772.25
	96"(2438mm)	WURA-2496-			S	1020.77	1412.45	1086.59	1478.27	1288.80	1680.48	2116.97	2739.14	2219.08	2841.25
	99"(2515mm)	WURA-2499-			S	1046.99	1446.59	1114.58	1514.18	1322.37	1721.97	2169.38	2805.62	2274.01	2910.25
	102"(2591mm)	WURA-24A2-			S	1073.21	1480.73	1142.57	1550.09	1355.94	1763.46	2221.79	2872.10	2328.94	2979.25
	105"(2667mm)	WURA-24A5-			S	1099.43	1514.87	1170.56	1586.00	1389.51	1804.95	2274.20	2938.58	2383.87	3048.25
	108"(2743mm)	WURA-24A8-			S	1125.65	1549.01	1198.55	1621.91	1423.08	1846.44	2326.61	3005.06	2438.80	3117.25
	111"(2819mm)	WURA-24B1-			S	1151.87	1583.15	1226.54	1657.82	1456.65	1887.93	2379.02	3071.54	2493.73	3186.25
	114"(2890mm)	WURA-24B4-			S	1178.09	1617.29	1254.53	1693.73	1490.22	1929.42	2431.43	3138.02	2548.66	3255.25
	117"(2972mm)	WURA-24B7-			S	1204.31	1651.43	1282.52	1729.64	1523.79	1970.91	2483.84	3204.50	2603.59	3324.25
	120"(3048mm)	WURA-24C0-			S	1230.53	1685.57	1310.51	1765.55	1557.36	2012.40	2536.25	3270.98	2658.52	3393.25

Adaptable Worksurfaces

Rectangular

Depth	Width	Number	①	②	③	Laminate A		Laminate B		Laminate E		Wood Group A		Wood Group B	
						J	F	J	F	J	F	K	U	K	U
30"(762mm)	24"(610mm)	WURA-3024-	■	■	S	\$ 430.67	\$ 692.54	\$ 454.01	\$ 715.88	\$ 522.30	\$ 784.17	\$1099.91	\$1479.79	\$1141.54	\$1521.42
	27"(686mm)	WURA-3027-	■	■	S	458.57	725.72	483.68	750.83	557.55	824.70	1157.42	1546.68	1201.57	1590.83
	30"(762mm)	WURA-3030-	■	■	S	487.31	762.38	514.19	789.26	593.64	868.71	1214.93	1618.26	1261.60	1664.93
	33"(838mm)	WURA-3033-	■	■	S	516.05	799.04	544.70	827.69	629.73	912.72	1272.44	1689.84	1321.63	1739.03
	36"(914mm)	WURA-3036-	■	■	S	544.79	835.70	575.21	866.12	665.82	956.73	1329.95	1761.42	1381.66	1813.13
	39"(991mm)	WURA-3039-	■	■	S	573.53	872.36	605.72	904.55	701.91	1000.74	1387.46	1833.00	1441.69	1887.23
	42"(1067mm)	WURA-3042-	■	■	S	602.27	909.02	636.23	942.98	738.00	1044.75	1444.97	1904.58	1501.72	1961.33
	45"(1143mm)	WURA-3045-	■	■	S	631.01	945.68	666.74	981.41	774.09	1088.76	1502.48	1976.16	1561.75	2035.43
	48"(1219mm)	WURA-3048-	■	■	S	713.05	1035.64	750.55	1073.14	863.48	1186.07	1668.29	2156.04	1730.08	2217.83
	51"(1295mm)	WURA-3051-	■	■	S	741.79	1072.30	781.06	1111.57	899.57	1230.08	1725.80	2227.62	1790.11	2291.93
	54"(1372mm)	WURA-3054-	■	■	S	770.53	1108.96	811.57	1150.00	935.66	1274.09	1783.31	2299.20	1850.14	2366.03
	57"(1448mm)	WURA-3057-	■	■	S	799.27	1145.62	842.08	1188.43	971.75	1318.10	1840.82	2370.78	1910.17	2440.13
	60"(1524mm)	WURA-3060-	■	■	S	828.01	1182.28	872.59	1226.86	1007.84	1362.11	1898.33	2442.36	1970.20	2514.23
	63"(1600mm)	WURA-3063-	■	■	S	856.75	1218.94	903.10	1265.29	1043.93	1406.12	1955.84	2513.94	2030.23	2588.33
	66"(1676mm)	WURA-3066-	■	■	S	885.49	1255.60	933.61	1303.72	1080.02	1450.13	2013.35	2585.52	2090.26	2662.43
	69"(1753mm)	WURA-3069-	■	■	S	914.23	1292.26	964.12	1342.15	1116.11	1494.14	2070.86	2657.10	2150.29	2736.53
	72"(1829mm)	WURA-3072-	■	■	S	942.97	1328.92	994.63	1380.58	1152.20	1538.15	2128.37	2728.68	2210.32	2810.63
	75"(1905mm)	WURA-3075-	■	■	S	971.71	1365.58	1025.14	1419.01	1188.29	1582.16	2185.88	2800.26	2270.35	2884.73
	78"(1981mm)	WURA-3078-	■	■	S	1000.45	1402.24	1055.65	1457.44	1224.38	1626.17	2243.39	2871.84	2330.38	2958.83
	81"(2057mm)	WURA-3081-	■	■	S	1029.19	1438.90	1086.16	1495.87	1260.47	1670.18	2300.90	2943.42	2390.41	3032.93
	84"(2134mm)	WURA-3084-	■	■	S	1057.93	1475.56	1116.67	1534.30	1296.56	1714.19	2358.41	3015.00	2450.44	3107.03
	87"(2210mm)	WURA-3087-	■	■	S	1086.67	1512.22	1147.18	1572.73	1332.65	1758.20	2415.92	3086.58	2510.47	3181.13
	90"(2286mm)	WURA-3090-	■	■	S	1115.41	1548.88	1177.69	1611.16	1368.74	1802.21	2473.43	3158.16	2570.50	3255.23
	93"(2362mm)	WURA-3093-	■	■	S	1144.15	1585.54	1208.20	1649.59	1404.83	1846.22	2530.94	3229.74	2630.53	3329.33
	96"(2438mm)	WURA-3096-	■	■	S	1172.89	1622.20	1238.71	1688.02	1440.92	1890.23	2588.45	3301.32	2690.56	3403.43
	99"(2515mm)	WURA-3099-	■	■	S	1201.63	1658.86	1269.22	1726.45	1477.01	1934.24	2645.96	3372.90	2750.59	3477.53
	102"(2591mm)	WURA-30A2-	■	■	S	1230.37	1695.52	1299.73	1764.88	1513.10	1978.25	2703.47	3444.48	2810.62	3551.63
	105"(2667mm)	WURA-30A5-	■	■	S	1259.11	1732.18	1330.24	1803.31	1549.19	2022.26	2760.98	3516.06	2870.65	3625.73
	108"(2743mm)	WURA-30A8-	■	■	S	1287.85	1768.84	1360.75	1841.74	1585.28	2066.27	2818.49	3587.64	2930.68	3699.83
	111"(2819mm)	WURA-30B1-	■	■	S	1316.59	1805.50	1391.26	1880.17	1621.37	2110.28	2876.00	3659.22	2990.71	3773.93
	114"(2890mm)	WURA-30B4-	■	■	S	1345.33	1842.16	1421.77	1918.60	1657.46	2154.29	2933.51	3730.80	3050.74	3848.03
	117"(2972mm)	WURA-30B7-	■	■	S	1374.07	1878.82	1452.28	1957.03	1693.55	2198.30	2991.02	3802.38	3110.77	3922.13
	120"(3048mm)	WURA-30C0-	■	■	S	1402.81	1915.48	1482.79	1995.46	1729.64	2242.31	3048.53	3873.96	3170.80	3996.23

Adaptable Worksurfaces

Rectangular Worksurface and Rectangular Adjustable Split Top

To Create Rectangular Worksurface with Split Top

Rectangular Worksurface

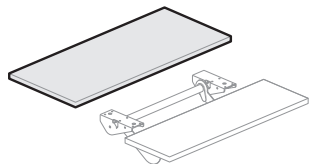

WURA

Features

- Includes worksurface and tie plate.
- Laminate with 3mm edgeband (J) user edge and 1mm edgeband on sides and back.
- Worksurfaces predrilled to accept most support options.
- Optional wireway along back edge of worksurface is color-matched to solid side/back edge trim. Refer to Specification Guide for wireway details.
- Worksurfaces have one wireway.
- **Installed worksurfaces without wireway will not allow clearance for power plug.**
- Depths and widths shown in nominal dimensions.

To Order, Specify:

- 1) Product number.
- 2) Laminate surface color.
- 3) Edge trim color.

Specification Tips

- **To create a split top application, an 18" D WURA must be used in conjunction with a WUKR split top. Overall worksurface depth with Split Top is 30" D.**
- **Suspended accessories cannot be attached to WURA worksurface with a WUKR split top.**
- **Do not attach pedestals.**
- **Separately specify worksurface supports for the product line and worksurface. Refer to the Specification Guide for support and load guidelines.**

Depth	Width	Number	Laminate A J	Laminate B J
Notched				
18"(457mm)	36"(914mm)	WURA-1836-LJSA	\$391.84	\$422.26
	42"(1067mm)	WURA-1842-LJSA	439.48	473.44
	48"(1219mm)	WURA-1848-LJSA	540.42	577.92
Without Notch				
18"(457mm)	36"(914mm)	WURA-1836-LJSC	\$391.84	\$422.26
	42"(1067mm)	WURA-1842-LJSC	439.48	473.44
	48"(1219mm)	WURA-1848-LJSC	540.42	577.92

Rectangular Adjustable Split Top

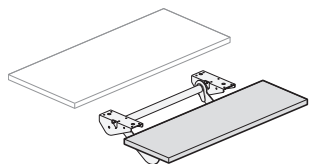

WUKR

Features

- Includes one split rectangular worksurface with a spring assist mechanism that must be used in conjunction with a rectangular worksurface for a split top application.
- Laminate with 3mm edgeband (J) on front and rear front edge, and 1mm on back and side edge of front worksurface.
- Spring assist mechanism:
 - Available in charcoal finish color only.
 - Spring assisted adjustment (with manual lock) of 6"(152mm) above worksurface and 6"(152mm) below.
- Depths and widths shown in nominal and actual dimensions.

To Order, Specify:

- 1) Product number.
- 2) Laminate surface color.
- 3) Edge trim color.

Specification Tips

- **To create a split top application, an 18" D WURA must be used in conjunction with a WUKR split top.**
- Rectangular worksurface split top applications are designed to align with adjacent 30"(762mm)-depth worksurfaces; split top is designed to allow pinch point clearance to accommodate cables.
- Not designed for use on worksurfaces with knife edge.
- Refer to the Specification Guide for application guidelines.

Depth	Actual Width	Nominal Width	Number	Laminate A J	Laminate B J
12"(305mm)	34"(864mm)	36"(914mm)	WUKR-1236-LJSC	\$2227.29	\$2591.67
	40"(1016mm)	42"(1067mm)	WUKR-1242-LJSC	2374.79	2763.33
	46"(1168mm)	48"(1219mm)	WUKR-1248-LJSC	2522.29	2934.99

Adaptable Worksurfaces

Rectangular Key

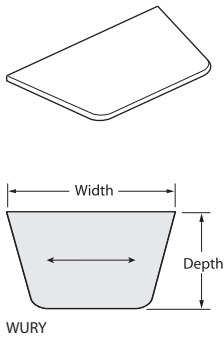

Features

- Includes worksurface and tie plate.
- Laminate with 3mm edgeband (J) or knife edge (F) on user edge and 1mm edgeband on sides and back.
- Wood veneer surface with 3mm edgeband (K) or knife (U) on user edge and 1mm edgeband on sides and back.
- **Worksurface width dimension attaches directly to panel and matches panel width.**
- Worksurfaces predrilled to accept most support options.
- Optional wireways along back edges are color-matched to solid side/back edge trim. When wood veneer or wood grain or patterned laminate is specified, wireways will be Charcoal. Refer to Specification Guide for wireway details.
- 72"(1829mm) wide worksurfaces have two wireways when 'A' option ordered.
- **Installed worksurfaces without wireway will not allow clearance for power plug.**
- Depths and widths shown in nominal dimensions.

Specification Tips

- **Worksurface support specific to product line and worksurface edge guidelines; must be separately specified; refer to Specification Guide for support and load.**
–Flush mount plate
- Knife edge requires use of worksurface supports for that application; worksurface support panel and/or side bracket for use with knife edge.
- **Support post or height adjustment disc base is required.**

To Order, Specify:

1) Product number, including:

1 Surface Options:

- L** Laminate
- W** Wood

2 Edge Options:

Laminate:

- J** Edgeband
- F** Knife

Wood:

- K** Edgeband
- U** Knife

3 Wireway Options:

- A** Notched
- C** Without

2) Laminate surface color or Wood finish color.

3) Edge trim color (laminate only).

Depth	Width	Number	①	②	③	Laminate A		Laminate B		Laminate E		Wood Group A		Wood Group B	
						J	F	J	F	J	F	K	U	K	U
30"(762mm)	36"(914mm)	WURY-3036-	■	■	S	\$ 982.83	\$1393.07	\$1054.92	\$1465.16	\$1272.93	\$1683.17	\$2681.21	\$3571.09	\$2841.21	\$3731.09
	48"(1219mm)	WURY-3048-	■	■	S	1044.70	1476.75	1121.02	1553.07	1365.47	1797.52	2824.49	3756.04	3010.01	3941.56
36"(914mm)	48"(1219mm)	WURY-3648-	■	■	S	\$1108.70	\$1560.96	\$1189.58	\$1641.84	\$1462.83	\$1915.09	\$2990.64	\$3968.77	\$3205.71	\$4183.84
	60"(1524mm)	WURY-3660-	■	■	S	1170.57	1644.64	1255.68	1729.75	1555.37	2029.44	3133.92	4153.72	3374.51	4394.31
	72"(1829mm)	WURY-3672-	■	■	S	1232.44	1728.32	1321.78	1817.66	1647.91	2143.79	3277.20	4338.67	3543.31	4604.78
42"(1067mm)	60"(1524mm)	WURY-4260-	■	■	S	\$1234.57	\$1728.85	\$1324.24	\$1818.52	\$1652.73	\$2147.01	\$3300.07	\$4366.45	\$3570.21	\$4636.59
	72"(1829mm)	WURY-4272-	■	■	S	1296.44	1812.53	1390.34	1906.43	1745.27	2261.36	3443.35	4551.40	3739.01	4847.06
48"(1219mm)	60"(1524mm)	WURY-4860-	■	■	S	\$1298.57	\$1813.06	\$1392.80	\$1907.29	\$1750.09	\$2264.58	\$3466.22	\$4579.18	\$3765.91	\$4878.87
	72"(1829mm)	WURY-4872-	■	■	S	1360.44	1896.74	1458.90	1995.20	1842.63	2378.93	3609.50	4764.13	3934.71	5089.34

Adaptable Worksurfaces

Rectangular Swell



WURS

Features

- Includes work surface and tie plate.
- Laminate with 3mm edgeband (J) or knife edge (F) on user edge and 1mm edgeband on sides and back.
- Wood veneer work surface with 3mm edgeband (K) or knife (U) on user edge and 1mm edgeband on sides and back.
- Worksurfaces predrilled to accept most support options.
- Optional wireway along back edge of work surface is color-matched to solid side/back edge trim. When wood veneer or wood grain or patterned laminate is specified, wireway will be Charcoal. Refer to Specification Guide for wireway details.
- **Installed worksurfaces without wireway will not allow clearance for power plug.**
- Depths and widths shown in nominal dimensions.

Specification Tips

- **Work surface support specific to product line and work surface edge guidelines; must be separately specified; refer to Specification Guide for support and load.**
 - Standard cantilever brackets
 - Side brackets
 - Work surface support panel
 - Support post or support column
 - P-Leg
- Knife edge requires use of work surface supports for that application; work surface support panel and/or side bracket for use with knife edge.
- Mini cantilever brackets are for use with 18”(457mm) deep work surfaces with knife edge only.
- Suggested pedestal style is mobile.

Note: Separately specified work surface reinforcement channels provide additional support for work surfaces with 50”(1270mm) spans that are heavily loaded and not otherwise supported by mid-span cantilevers, work surface support panels, columns or legs.

To Order, Specify:

1) Product number, including:

1 Surface Options:

- L** Laminate
- W** Wood

2 Edge Options:

Laminate:

- J** Edgeband
- F** Knife

Wood:

- K** Edgeband
- U** Knife

3 Wireway Options:

- A** Notched
- C** Without

2) Laminate surface color or Wood finish color.

3) Edge trim color (laminate only).

Depth	Swell Depth	Width	Number	① ② ③			Laminate A		Laminate B		Laminate E		Wood Group A		Wood Group B	
				J	F	S	J	F	J	F	K	U	K	U		
18”(457mm)	21”(533mm)	24”(610mm)	WURS-1824-	J	F	S	\$442.18	\$ 686.35	\$473.21	\$ 717.38	\$ 571.48	\$ 815.65	\$ 904.93	\$1247.20	\$ 956.63	\$1298.90
		30”(762mm)	WURS-1830-	J	F	S	487.86	745.73	522.13	780.00	630.66	888.53	996.01	1362.38	1052.99	1419.36
		36”(914mm)	WURS-1836-	J	F	S	534.42	808.73	571.93	846.24	690.72	965.03	1087.09	1482.38	1149.35	1544.64
		42”(1067mm)	WURS-1842-	J	F	S	580.98	871.73	621.73	912.48	750.78	1041.53	1178.17	1602.38	1245.71	1669.92
		48”(1219mm)	WURS-1848-	J	F	S	627.54	934.73	671.53	978.72	810.84	1118.03	1269.25	1722.38	1342.07	1795.20
		54”(1372mm)	WURS-1854-	J	F	S	674.10	997.73	721.33	1044.96	870.90	1194.53	1360.33	1842.38	1438.43	1920.48
24”(610mm)	27”(686mm)	60”(1524mm)	WURS-1860-	J	F	S	720.66	1060.73	771.13	1111.20	930.96	1271.03	1451.41	1962.38	1534.79	2045.76
		24”(610mm)	WURS-2424-	J	F	S	\$457.68	\$ 708.67	\$488.71	\$ 739.70	\$ 586.98	\$ 837.97	\$ 935.99	\$1286.81	\$ 987.69	\$1338.51
		30”(762mm)	WURS-2430-	J	F	S	503.36	768.05	537.63	802.32	646.16	910.85	1032.29	1407.21	1089.27	1464.19
		36”(914mm)	WURS-2436-	J	F	S	549.92	831.05	587.43	868.56	706.22	987.35	1128.59	1532.43	1190.85	1594.69
		42”(1067mm)	WURS-2442-	J	F	S	596.48	894.05	637.23	934.80	766.28	1063.85	1224.89	1657.65	1292.43	1725.19
		48”(1219mm)	WURS-2448-	J	F	S	643.04	957.05	687.03	1001.04	826.34	1140.35	1321.19	1782.87	1394.01	1855.69
30”(762mm)	33”(838mm)	54”(1372mm)	WURS-2454-	J	F	S	689.60	1020.05	736.83	1067.28	886.40	1216.85	1417.49	1908.09	1495.59	1986.19
		60”(1524mm)	WURS-2460-	J	F	S	736.16	1083.05	786.63	1133.52	946.46	1293.35	1513.79	2033.31	1597.17	2116.69
		24”(610mm)	WURS-3024-	J	F	S	\$599.02	\$ 894.24	\$630.05	\$ 925.27	\$ 728.32	\$1023.54	\$1228.99	\$1656.61	\$1280.69	\$1708.31
		30”(762mm)	WURS-3030-	J	F	S	644.70	953.62	678.97	987.89	787.50	1096.42	1330.27	1781.99	1387.25	1838.97
		36”(914mm)	WURS-3036-	J	F	S	691.26	1016.62	728.77	1054.13	847.56	1172.92	1431.55	1912.19	1493.81	1974.45
		42”(1067mm)	WURS-3042-	J	F	S	737.82	1079.62	778.57	1120.37	907.62	1249.42	1532.83	2042.39	1600.37	2109.93
48”(1219mm)	54”(1372mm)	48”(1219mm)	WURS-3048-	J	F	S	784.38	1142.62	828.37	1186.61	967.68	1325.92	1634.11	2172.59	1706.93	2245.41
		54”(1372mm)	WURS-3054-	J	F	S	830.94	1205.62	878.17	1252.85	1027.74	1402.42	1735.39	2302.79	1813.49	2380.89
		60”(1524mm)	WURS-3060-	J	F	S	877.50	1268.62	927.97	1319.09	1087.80	1478.92	1836.67	2432.99	1920.05	2516.37

Adaptable Worksurfaces

Rectangular Inverse Swell

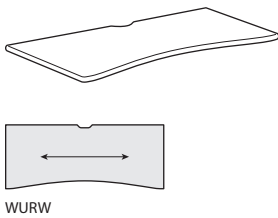

WURW

Features

- Includes worksurface and tie plate.
- Laminate with 3mm edgeband (J) or knife edge (F) on user edge and 1mm edgeband on sides and back.
- Wood veneer worksurface with 3mm edgeband (K) of knife (U) on user edge and 1mm edgeband on sides and back.
- Worksurfaces predrilled to accept most support options.
- Optional wireway along back edge of worksurface is color-matched to solid side/back edge trim. When wood veneer or wood grain or patterned laminate is specified, wireway will be Charcoal. Refer to Specification Guide for wireway details.
- **Installed worksurfaces without wireway will not allow clearance for power plug.**
- Depths and widths shown in nominal dimensions.

Specification Tips

- **Worksurface support specific to product line and worksurface edge guidelines; must be separately specified; refer to Specification Guide for support and load.**
 - Standard cantilever brackets
 - Side/corner brackets
 - Worksurface support panel
 - Worksurface support post or support column
 - P-Leg
- Knife edge requires use of worksurface supports for that application; worksurface support panel and/or side bracket for use with knife edge.
- Mini cantilever brackets are for use with 18”(457mm) deep worksurfaces with knife edge only.
- Suggested pedestal style is mobile.

Note: Separately specified worksurface reinforcement channels provide additional support for worksurfaces with 50”(1270mm) spans that are heavily loaded and not otherwise supported by mid-span cantilevers, worksurface support panels, columns or legs.

To Order, Specify:

1) Product number, including:

1 Surface Options:

- L** Laminate
- W** Wood

2 Edge Options:

Laminate:

- J** Edgeband
- F** Knife

Wood:

- K** Edgeband
- U** Knife

3 Wireway Options:

- A** Notched
- C** Without

2) Laminate surface color or Wood finish color.

3) Edge trim color (laminate only).

Depth	Swell Depth	Width	Number	①	②	③	Laminate A		Laminate B		Laminate E		Wood Group A		Wood Group B	
							J	F	J	F	J	F	K	U	K	U
18”(457mm)	15”(381mm)	24”(610mm)	WURW-1824-	■	S	■	\$423.10	\$ 656.78	\$452.78	\$ 686.46	\$ 546.84	\$ 780.52	\$ 947.68	\$1275.22	\$ 997.15	\$1324.69
		30”(762mm)	WURW-1830-	■	S	■	466.68	713.56	499.30	746.18	603.26	850.14	1034.80	1385.39	1089.19	1439.78
		36”(914mm)	WURW-1836-	■	S	■	511.08	773.80	546.64	809.36	660.50	923.22	1121.92	1500.17	1181.23	1559.48
		42”(1067mm)	WURW-1842-	■	S	■	555.48	834.04	593.98	872.54	717.74	996.30	1209.04	1614.95	1273.27	1679.18
		48”(1219mm)	WURW-1848-	■	S	■	599.88	894.28	641.32	935.72	774.98	1069.38	1296.16	1729.73	1365.31	1798.88
		54”(1372mm)	WURW-1854-	■	S	■	644.28	954.52	688.66	998.90	832.22	1142.46	1383.28	1844.51	1457.35	1918.58
24”(610mm)	21”(533mm)	60”(1524mm)	WURW-1860-	■	S	■	688.68	1014.76	736.00	1062.08	889.46	1215.54	1470.40	1959.29	1549.39	2038.28
		24”(610mm)	WURW-2424-	■	S	■	\$437.94	\$ 678.13	\$467.62	\$ 707.81	\$ 561.68	\$ 801.87	\$ 977.39	\$1313.08	\$1026.86	\$1362.55
		30”(762mm)	WURW-2430-	■	S	■	481.52	734.91	514.14	767.53	618.10	871.49	1069.49	1428.23	1123.88	1482.62
		36”(914mm)	WURW-2436-	■	S	■	525.92	795.15	561.48	830.71	675.34	944.57	1161.59	1547.99	1220.90	1607.30
		42”(1067mm)	WURW-2442-	■	S	■	570.32	855.39	608.82	893.89	732.58	1017.65	1253.69	1667.75	1317.92	1731.98
		48”(1219mm)	WURW-2448-	■	S	■	614.72	915.63	656.16	957.07	789.82	1090.73	1345.79	1787.51	1414.94	1856.66
30”(762mm)	27”(686mm)	54”(1372mm)	WURW-2454-	■	S	■	659.12	975.87	703.50	1020.25	847.06	1163.81	1437.89	1907.27	1511.96	1981.34
		60”(1524mm)	WURW-2460-	■	S	■	703.52	1036.11	750.84	1083.43	904.30	1236.89	1529.99	2027.03	1608.98	2106.02
		24”(610mm)	WURW-3024-	■	S	■	\$573.19	\$ 855.73	\$602.87	\$ 885.41	\$ 696.93	\$ 979.47	\$1257.78	\$1666.97	\$1307.25	\$1716.44
		30”(762mm)	WURW-3030-	■	S	■	616.77	912.51	649.39	945.13	753.35	1049.09	1354.80	1787.04	1409.19	1841.43
		36”(914mm)	WURW-3036-	■	S	■	661.17	972.75	696.73	1008.31	810.59	1122.17	1451.82	1911.72	1511.13	1971.03
		42”(1067mm)	WURW-3042-	■	S	■	705.57	1032.99	744.07	1071.49	867.83	1195.25	1548.84	2036.40	1613.07	2100.63
48”(1219mm)	54”(1372mm)	48”(1219mm)	WURW-3048-	■	S	■	749.97	1093.23	791.41	1134.67	925.07	1268.33	1645.86	2161.08	1715.01	2230.23
		54”(1372mm)	WURW-3054-	■	S	■	794.37	1153.47	838.75	1197.85	982.31	1341.41	1742.88	2285.76	1816.95	2359.83
		60”(1524mm)	WURW-3060-	■	S	■	838.77	1213.71	886.09	1261.03	1039.55	1414.49	1839.90	2410.44	1918.89	2489.43

Adaptable Worksurfaces

Rectangular Transition

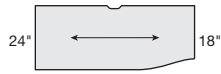

WURT-N43

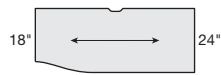

WURT-N34

Features

- Includes work surface and tie plate.
- Laminate with 3mm edgeband (J) or knife edge (F) on user edge and 1mm edgeband on sides and back.
- Wood veneer work surface with 3mm edgeband (K) or knife (U) on user edge and 1mm edgeband on sides and back.
- Work surfaces predrilled to accept most support options.
- Optional wireway along back edge of work surface is color-matched to solid side/back edge trim. When wood veneer or wood grain or patterned laminate is specified, wireway will be Charcoal. Refer to Specification Guide for wireway details.
- **Installed work surfaces without wireway will not allow clearance for power plug.**
- Depths and widths shown in nominal dimensions.

Specification Tips

- **Work surface support specific to product line and work surface edge guidelines; must be separately specified; refer to Specification Guide for support and load.**
 - Standard cantilever brackets
 - Side/corner brackets
 - Work surface support panel
 - Work surface support post or support column
 - P-Leg
 - Attached lower storage
- Knife edge requires use of work surface supports for that application; work surface support panel and/or side bracket for use with knife edge.
- Mini cantilever brackets are for use with 18"(457mm) deep work surfaces with knife edge only.
- For work surfaces less than 42"(1067mm)-wide, suggested pedestal style is mobile.
- For work surfaces greater than 42"(1067mm)-wide, attached pedestal may be installed on deepest side.

Note: Separately specified work surface reinforcement channels provide additional support for work surfaces with 50"(1270mm) spans that are heavily loaded and not otherwise supported by mid-span cantilevers, work surface support panels, columns, legs or attached lower storage.

To Order, Specify:

1) Product number, including:

① Surface Options:

- L** Laminate
- W** Wood

② Edge Options:

Laminate:

- J** Edgeband
- F** Knife

Wood:

- K** Edgeband
- U** Knife

③ Wireway Options:

- A** Notched
- C** Without

2) Laminate surface color or Wood finish color.

3) Edge trim color (laminate only).

Left/Right Depth	Width	Number	① ② ③			Laminate A		Laminate B		Laminate E		Wood Group A		Wood Group B	
			J	F	J	F	J	F	K	U	K	U			
18"(457mm)/24"(610mm)	24"(610mm)	WURT-2424-	L	S	N34	\$457.11	\$ 707.41	\$490.57	\$ 740.87	\$ 595.23	\$ 845.53	\$1032.69	\$1386.31	\$1082.94	\$1436.56
	30"(762mm)	WURT-2430-	L	S	N34	515.55	783.97	553.03	821.45	671.37	939.79	1153.35	1539.19	1209.72	1595.56
	36"(914mm)	WURT-2436-	L	S	N34	573.99	860.53	615.49	902.03	747.51	1034.05	1274.01	1692.07	1336.50	1754.56
	42"(1067mm)	WURT-2442-	L	S	N34	632.43	937.09	677.95	982.61	823.65	1128.31	1394.67	1844.95	1463.28	1913.56
	48"(1219mm)	WURT-2448-	L	S	N34	690.87	1013.65	740.41	1063.19	899.79	1222.57	1515.33	1997.83	1590.06	2072.56
	54"(1372mm)	WURT-2454-	L	S	N34	749.31	1090.21	802.87	1143.77	975.93	1316.83	1635.99	2150.71	1716.84	2231.56
24"(610mm)/18"(457mm)	24"(610mm)	WURT-2424-	L	S	N43	\$457.11	\$ 707.41	\$490.57	\$ 740.87	\$ 595.23	\$ 845.53	\$1032.69	\$1386.31	\$1082.94	\$1436.56
	30"(762mm)	WURT-2430-	L	S	N43	515.55	783.97	553.03	821.45	671.37	939.79	1153.35	1539.19	1209.72	1595.56
	36"(914mm)	WURT-2436-	L	S	N43	573.99	860.53	615.49	902.03	747.51	1034.05	1274.01	1692.07	1336.50	1754.56
	42"(1067mm)	WURT-2442-	L	S	N43	632.43	937.09	677.95	982.61	823.65	1128.31	1394.67	1844.95	1463.28	1913.56
	48"(1219mm)	WURT-2448-	L	S	N43	690.87	1013.65	740.41	1063.19	899.79	1222.57	1515.33	1997.83	1590.06	2072.56
	54"(1372mm)	WURT-2454-	L	S	N43	749.31	1090.21	802.87	1143.77	975.93	1316.83	1635.99	2150.71	1716.84	2231.56
24"(610mm)/30"(762mm)	24"(610mm)	WURT-3024-	L	S	N45	\$490.57	\$ 740.87	\$524.03	\$ 774.33	\$ 628.69	\$ 878.99	\$1066.15	\$1419.77	\$1116.40	\$1470.02
	30"(762mm)	WURT-3030-	L	S	N45	549.01	817.43	586.49	854.91	704.83	973.25	1186.81	1572.65	1243.18	1629.02
	36"(914mm)	WURT-3036-	L	S	N45	607.45	893.99	648.95	935.49	780.97	1067.51	1307.47	1725.53	1369.96	1788.02
	42"(1067mm)	WURT-3042-	L	S	N45	665.89	970.55	711.41	1016.07	857.11	1161.77	1428.13	1878.41	1496.74	1947.02
	48"(1219mm)	WURT-3048-	L	S	N45	724.33	1047.11	773.87	1096.65	933.25	1256.03	1548.79	2031.29	1623.52	2106.02
	54"(1372mm)	WURT-3054-	L	S	N45	782.77	1123.67	836.33	1177.23	1009.39	1350.29	1669.45	2184.17	1750.30	2265.02
30"(762mm)/24"(610mm)	24"(610mm)	WURT-3024-	L	S	N54	\$490.57	\$ 740.87	\$524.03	\$ 774.33	\$ 628.69	\$ 878.99	\$1066.15	\$1419.77	\$1116.40	\$1470.02
	30"(762mm)	WURT-3030-	L	S	N54	549.01	817.43	586.49	854.91	704.83	973.25	1186.81	1572.65	1243.18	1629.02
	36"(914mm)	WURT-3036-	L	S	N54	607.45	893.99	648.95	935.49	780.97	1067.51	1307.47	1725.53	1369.96	1788.02
	42"(1067mm)	WURT-3042-	L	S	N54	665.89	970.55	711.41	1016.07	857.11	1161.77	1428.13	1878.41	1496.74	1947.02
	48"(1219mm)	WURT-3048-	L	S	N54	724.33	1047.11	773.87	1096.65	933.25	1256.03	1548.79	2031.29	1623.52	2106.02
	54"(1372mm)	WURT-3054-	L	S	N54	782.77	1123.67	836.33	1177.23	1009.39	1350.29	1669.45	2184.17	1750.30	2265.02
30"(762mm)/30"(762mm)	24"(610mm)	WURT-3060-	L	S	N54	\$490.57	\$ 740.87	\$524.03	\$ 774.33	\$ 628.69	\$ 878.99	\$1066.15	\$1419.77	\$1116.40	\$1470.02
	30"(762mm)	WURT-3030-	L	S	N54	549.01	817.43	586.49	854.91	704.83	973.25	1186.81	1572.65	1243.18	1629.02
	36"(914mm)	WURT-3036-	L	S	N54	607.45	893.99	648.95	935.49	780.97	1067.51	1307.47	1725.53	1369.96	1788.02
	42"(1067mm)	WURT-3042-	L	S	N54	665.89	970.55	711.41	1016.07	857.11	1161.77	1428.13	1878.41	1496.74	1947.02
	48"(1219mm)	WURT-3048-	L	S	N54	724.33	1047.11	773.87	1096.65	933.25	1256.03	1548.79	2031.29	1623.52	2106.02
	54"(1372mm)	WURT-3054-	L	S	N54	782.77	1123.67	836.33	1177.23	1009.39	1350.29	1669.45	2184.17	1750.30	2265.02
30"(762mm)/42"(1067mm)	24"(610mm)	WURT-3060-	L	S	N54	\$490.57	\$ 740.87	\$524.03	\$ 774.33	\$ 628.69	\$ 878.99	\$1066.15	\$1419.77	\$1116.40	\$1470.02
	30"(762mm)	WURT-3030-	L	S	N54	549.01	817.43	586.49	854.91	704.83	973.25	1186.81	1572.65	1243.18	1629.02
	36"(914mm)	WURT-3036-	L	S	N54	607.45	893.99	648.95	935.49	780.97	1067.51	1307.47	1725.53	1369.96	1788.02
	42"(1067mm)	WURT-3042-	L	S	N54	665.89	970.55	711.41	1016.07	857.11	1161.77	1428.13	1878.41	1496.74	1947.02
	48"(1219mm)	WURT-3048-	L	S	N54	724.33	1047.11	773.87	1096.65	933.25	1256.03	1548.79	2031.29	1623.52	2106.02
	54"(1372mm)	WURT-3054-	L	S	N54	782.77	1123.67	836.33	1177.23	1009.39	1350.29	1669.45	2184.17	1750.30	2265.02

Adaptable Worksurfaces

Wedge

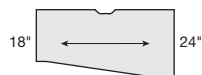
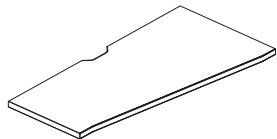

WURE-N34



WURE-N43

Features

- Includes work surface and tie plate.
- Laminate with 3mm edgeband (J) or knife edge (F) on user edge and 1mm edgeband on sides and back.
- Wood veneer surface with 3mm edgeband (K) or knife (U) on user edge and 1mm edgeband on sides and back.
- Worksurfaces predrilled to accept most support options.
- Optional wireways along back edges are color-matched to solid side/back edge trim. When wood veneer or wood grain or patterned laminate is specified, wireways will be Charcoal. Refer to Specification Guide for wireway details.
- **Installed worksurfaces without wireway will not allow clearance for power plug.**
- Depths and widths shown in nominal dimensions.

Specification Tips

- **Worksurface support specific to product line and work surface edge guidelines; must be separately specified; refer to Specification Guide for support and load.**
 - Standard cantilever brackets
 - Side/corner brackets
 - Worksurface support post or support column
 - P-Leg
- Knife edge requires use of work surface supports for that application; work surface support panel and/or side bracket for use with knife edge.
- Mini cantilever brackets are for use with 18" (457mm) deep worksurfaces with knife edge only.
- Suggested pedestal style is mobile.

Note: Separately specified work surface reinforcement channels provide additional support for worksurfaces with 50" (1270mm) spans that are heavily loaded and not otherwise supported by mid-span cantilevers, work surface end panels, posts or attached lower storage.

To Order, Specify:

1) Product number, including:

1 Surface Options:

L Laminate

W Wood

2 Edge Options:

Laminate:

J Edgeband

F Knife

Wood:

K Edgeband

U Knife

3 Wireway Options:

A Notched

C Without

2) Laminate surface color or Wood finish color.

3) Edge trim color (laminated only).

Adaptable Worksurfaces

Wedge

Left/Right Depth	Width	Number	Laminate A		Laminate B		Laminate E		Wood Group A		Wood Group B				
			J	F	J	F	J	F	K	U	K	U			
24"(610mm)/18"(457mm)	24"(610mm)	WURE-2424-	1	S	N43	\$ 528.82	\$ 779.80	\$ 563.82	\$ 814.80	\$ 668.37	\$ 919.35	\$1086.42	\$1420.37	\$1113.08	\$1447.03
	30"(762mm)	WURE-2430-	1	S	N43	584.86	857.86	623.82	896.82	740.43	1013.43	1206.30	1576.37	1247.90	1617.97
	36"(914mm)	WURE-2436-	1	S	N43	640.90	935.92	683.82	978.84	812.49	1107.51	1326.18	1732.37	1382.72	1788.91
	42"(1067mm)	WURE-2442-	1	S	N43	696.94	1013.98	743.82	1060.86	884.55	1201.59	1446.06	1888.37	1517.54	1959.85
	48"(1219mm)	WURE-2448-	1	S	N43	752.98	1092.04	803.82	1142.88	956.61	1295.67	1565.94	2044.37	1652.36	2130.79
	54"(1372mm)	WURE-2454-	1	S	N43	809.02	1170.10	863.82	1224.90	1028.67	1389.75	1685.82	2200.37	1787.18	2301.73
	60"(1524mm)	WURE-2460-	1	S	N43	865.06	1248.16	923.82	1306.92	1100.73	1483.83	1805.70	2356.37	1922.00	2472.67
	66"(1676mm)	WURE-2466-	1	S	N43	921.10	1326.22	983.82	1388.94	1172.79	1577.91	1925.58	2512.37	2056.82	2643.61
	72"(1829mm)	WURE-2472-	1	S	N43	977.14	1404.28	1043.82	1470.96	1244.85	1671.99	2045.46	2668.37	2191.64	2814.55
	78"(1981mm)	WURE-2478-	1	S	N43	1033.18	1482.34	1103.82	1552.98	1316.91	1766.07	2165.34	2824.37	2326.46	2985.49
	84"(2134mm)	WURE-2484-	1	S	N43	1089.22	1560.40	1163.82	1635.00	1388.97	1860.15	2285.22	2980.37	2461.28	3156.43
	90"(2286mm)	WURE-2490-	1	S	N43	1145.26	1638.46	1223.82	1717.02	1461.03	1954.23	2405.10	3136.37	2596.10	3327.37
	96"(2438mm)	WURE-2496-	1	S	N43	1201.30	1716.52	1283.82	1799.04	1533.09	2048.31	2524.98	3292.37	2730.92	3498.31
18"(457mm)/24"(610mm)	24"(610mm)	WURE-2424-	1	S	N34	\$ 528.82	\$ 779.80	\$ 563.82	\$ 814.80	\$ 668.37	\$ 919.35	\$1086.42	\$1420.37	\$1113.08	\$1447.03
	30"(762mm)	WURE-2430-	1	S	N34	584.86	857.86	623.82	896.82	740.43	1013.43	1206.30	1576.37	1247.90	1617.97
	36"(914mm)	WURE-2436-	1	S	N34	640.90	935.92	683.82	978.84	812.49	1107.51	1326.18	1732.37	1382.72	1788.91
	42"(1067mm)	WURE-2442-	1	S	N34	696.94	1013.98	743.82	1060.86	884.55	1201.59	1446.06	1888.37	1517.54	1959.85
	48"(1219mm)	WURE-2448-	1	S	N34	752.98	1092.04	803.82	1142.88	956.61	1295.67	1565.94	2044.37	1652.36	2130.79
	54"(1372mm)	WURE-2454-	1	S	N34	809.02	1170.10	863.82	1224.90	1028.67	1389.75	1685.82	2200.37	1787.18	2301.73
	60"(1524mm)	WURE-2460-	1	S	N34	865.06	1248.16	923.82	1306.92	1100.73	1483.83	1805.70	2356.37	1922.00	2472.67
	66"(1676mm)	WURE-2466-	1	S	N34	921.10	1326.22	983.82	1388.94	1172.79	1577.91	1925.58	2512.37	2056.82	2643.61
	72"(1829mm)	WURE-2472-	1	S	N34	977.14	1404.28	1043.82	1470.96	1244.85	1671.99	2045.46	2668.37	2191.64	2814.55
	78"(1981mm)	WURE-2478-	1	S	N34	1033.18	1482.34	1103.82	1552.98	1316.91	1766.07	2165.34	2824.37	2326.46	2985.49
	84"(2134mm)	WURE-2484-	1	S	N34	1089.22	1560.40	1163.82	1635.00	1388.97	1860.15	2285.22	2980.37	2461.28	3156.43
	90"(2286mm)	WURE-2490-	1	S	N34	1145.26	1638.46	1223.82	1717.02	1461.03	1954.23	2405.10	3136.37	2596.10	3327.37
	96"(2438mm)	WURE-2496-	1	S	N34	1201.30	1716.52	1283.82	1799.04	1533.09	2048.31	2524.98	3292.37	2730.92	3498.31
30"(762mm)/24"(610mm)	24"(610mm)	WURE-3024-	1	S	N54	\$ 545.46	\$ 796.44	\$ 580.46	\$ 831.44	\$ 685.01	\$ 935.99	\$1103.06	\$1437.01	\$1129.72	\$1463.67
	30"(762mm)	WURE-3030-	1	S	N54	601.50	874.50	640.46	913.46	757.07	1030.07	1222.94	1593.01	1264.54	1634.61
	36"(914mm)	WURE-3036-	1	S	N54	657.54	952.56	700.46	995.48	829.13	1124.15	1342.82	1749.01	1399.36	1805.55
	42"(1067mm)	WURE-3042-	1	S	N54	713.58	1030.62	760.46	1077.50	901.19	1218.23	1462.70	1905.01	1534.18	1976.49
	48"(1219mm)	WURE-3048-	1	S	N54	769.62	1108.68	820.46	1159.52	973.25	1312.31	1582.58	2061.01	1669.00	2147.43
	54"(1372mm)	WURE-3054-	1	S	N54	825.66	1186.74	880.46	1241.54	1045.31	1406.39	1702.46	2217.01	1803.82	2318.37
	60"(1524mm)	WURE-3060-	1	S	N54	881.70	1264.80	940.46	1323.56	1117.37	1500.47	1822.34	2373.01	1938.64	2489.31
	66"(1676mm)	WURE-3066-	1	S	N54	937.74	1342.86	1000.46	1405.58	1189.43	1594.55	1942.22	2529.01	2073.46	2660.25
	72"(1829mm)	WURE-3072-	1	S	N54	993.78	1420.92	1060.46	1487.60	1261.49	1688.63	2062.10	2685.01	2208.28	2831.19
	78"(1981mm)	WURE-3078-	1	S	N54	1049.82	1498.98	1120.46	1569.62	1333.55	1782.71	2181.98	2841.01	2343.10	3002.13
	84"(2134mm)	WURE-3084-	1	S	N54	1105.86	1577.04	1180.46	1651.64	1405.61	1876.79	2301.86	2997.01	2477.92	3173.07
	90"(2286mm)	WURE-3090-	1	S	N54	1161.90	1655.10	1240.46	1733.66	1477.67	1970.87	2421.74	3153.01	2612.74	3344.01
	96"(2438mm)	WURE-3096-	1	S	N54	1217.94	1733.16	1300.46	1815.68	1549.73	2064.95	2541.62	3309.01	2747.56	3514.95
24"(610mm)/30"(762mm)	24"(610mm)	WURE-3024-	1	S	N45	\$ 545.46	\$ 796.44	\$ 580.46	\$ 831.44	\$ 685.01	\$ 935.99	\$1103.06	\$1437.01	\$1129.72	\$1463.67
	30"(762mm)	WURE-3030-	1	S	N45	601.50	874.50	640.46	913.46	757.07	1030.07	1222.94	1593.01	1264.54	1634.61
	36"(914mm)	WURE-3036-	1	S	N45	657.54	952.56	700.46	995.48	829.13	1124.15	1342.82	1749.01	1399.36	1805.55
	42"(1067mm)	WURE-3042-	1	S	N45	713.58	1030.62	760.46	1077.50	901.19	1218.23	1462.70	1905.01	1534.18	1976.49
	48"(1219mm)	WURE-3048-	1	S	N45	769.62	1108.68	820.46	1159.52	973.25	1312.31	1582.58	2061.01	1669.00	2147.43
	54"(1372mm)	WURE-3054-	1	S	N45	825.66	1186.74	880.46	1241.54	1045.31	1406.39	1702.46	2217.01	1803.82	2318.37
	60"(1524mm)	WURE-3060-	1	S	N45	881.70	1264.80	940.46	1323.56	1117.37	1500.47	1822.34	2373.01	1938.64	2489.31
	66"(1676mm)	WURE-3066-	1	S	N45	937.74	1342.86	1000.46	1405.58	1189.43	1594.55	1942.22	2529.01	2073.46	2660.25
	72"(1829mm)	WURE-3072-	1	S	N45	993.78	1420.92	1060.46	1487.60	1261.49	1688.63	2062.10	2685.01	2208.28	2831.19
	78"(1981mm)	WURE-3078-	1	S	N45	1049.82	1498.98	1120.46	1569.62	1333.55	1782.71	2181.98	2841.01	2343.10	3002.13
	84"(2134mm)	WURE-3084-	1	S	N45	1105.86	1577.04	1180.46	1651.64	1405.61	1876.79	2301.86	2997.01	2477.92	3173.07
	90"(2286mm)	WURE-3090-	1	S	N45	1161.90	1655.10	1240.46	1733.66	1477.67	1970.87	2421.74	3153.01	2612.74	3344.01
	96"(2438mm)	WURE-3096-	1	S	N45	1217.94	1733.16	1300.46	1815.68	1549.73	2064.95	2541.62	3309.01	2747.56	3514.95

Adaptable Worksurfaces

Sharp Wedge

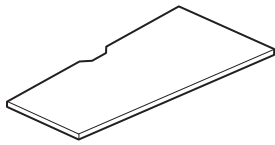

WURG-N34



WURG-N43

Features

- Includes worksurface and tie plate.
- Laminate with 3mm edgeband (J) or knife edge (F) on user edge and 1mm edgeband on sides and back.
- Wood veneer surface with 3mm edgeband (K) or knife (U) on user edge and 1mm edgeband on sides and back.
- Worksurfaces predrilled to accept most support options.
- Optional wireways along back edges are color-matched to solid side/back edge trim. When wood veneer or wood grain or patterned laminate is specified, wireways will be Charcoal. Refer to Specification Guide for wireway details.
- **Installed worksurfaces without wireway will not allow clearance for power plug.**
- Depths and widths shown in nominal dimensions.

Specification Tips

- **Worksurface support specific to product line and worksurface edge guidelines; must be separately specified.**
 - Standard cantilever brackets
 - Side/corner brackets
 - Worksurface support post or support column
 - P-Leg not recommended**
- Knife edge requires use of worksurface supports for that application; worksurface support panel and/or side bracket for use with knife edge.
- Mini cantilever brackets are for use with 18"(457mm) deep worksurfaces with knife edge only.
- Suggested pedestal style is mobile.

Note: Separately specified worksurface reinforcement channels provide additional support for worksurfaces with 50"(1270mm) spans that are heavily loaded and not otherwise supported by mid-span cantilevers, worksurface end panels, posts or attached lower storage.

To Order, Specify:

- 1) Product number, including:

① Surface Options:

- L Laminate
- W Wood

② Edge Options:

Laminate:

- J Edgeband

- F Knife

Wood:

- K Edgeband

- U Knife

③ Wireway Options:

- A Notched

- C Without

- 2) Laminate surface color or Wood finish color.

- 3) Edge trim color (laminate only).

Left/Right Depth	Width	Number	① ② ③	Laminate A		Laminate B		Laminate E		Wood Group A		Wood Group B		
				J	F	J	F	J	F	K	U	K	U	
24"(610mm)/18"(457mm)	24"(610mm)	WURG-2424-	S	N43	\$561.58	\$ 815.25	\$598.40	\$ 852.07	\$ 708.06	\$ 961.73	\$1148.24	\$1495.23	\$1253.70	\$1600.69
	30"(762mm)	WURG-2430-	S	N43	624.22	898.97	661.15	935.90	785.20	1059.95	1276.83	1662.16	1405.15	1790.48
	36"(914mm)	WURG-2436-	S	N43	686.86	982.69	723.90	1019.73	862.34	1158.17	1405.42	1829.09	1556.60	1980.27
	42"(1067mm)	WURG-2442-	S	N43	749.50	1066.41	786.65	1103.56	939.48	1256.39	1534.01	1996.02	1708.05	2170.06
	48"(1219mm)	WURG-2448-	S	N43	812.14	1150.13	849.40	1187.39	1016.62	1354.61	1662.60	2162.95	1859.50	2359.85
	54"(1372mm)	WURG-2454-	S	N43	874.78	1233.85	912.15	1271.22	1093.76	1452.83	1791.19	2329.88	2010.95	2549.64
18"(457mm)/24"(610mm)	24"(610mm)	WURG-2424-	S	N34	\$561.58	\$ 815.25	\$598.40	\$ 852.07	\$ 708.06	\$ 961.73	\$1148.24	\$1495.23	\$1253.70	\$1600.69
	30"(762mm)	WURG-2430-	S	N34	624.22	898.97	661.15	935.90	785.20	1059.95	1276.83	1662.16	1405.15	1790.48
	36"(914mm)	WURG-2436-	S	N34	686.86	982.69	723.90	1019.73	862.34	1158.17	1405.42	1829.09	1556.60	1980.27
	42"(1067mm)	WURG-2442-	S	N34	749.50	1066.41	786.65	1103.56	939.48	1256.39	1534.01	1996.02	1708.05	2170.06
	48"(1219mm)	WURG-2448-	S	N34	812.14	1150.13	849.40	1187.39	1016.62	1354.61	1662.60	2162.95	1859.50	2359.85
	54"(1372mm)	WURG-2454-	S	N34	874.78	1233.85	912.15	1271.22	1093.76	1452.83	1791.19	2329.88	2010.95	2549.64
30"(762mm)/24"(610mm)	24"(610mm)	WURG-3024-	S	N54	\$570.78	\$ 832.49	\$608.07	\$ 869.78	\$ 720.72	\$ 982.43	\$1172.84	\$1519.83	\$1282.68	\$1629.67
	30"(762mm)	WURG-3030-	S	N54	633.42	916.21	670.82	953.61	797.86	1080.65	1301.43	1686.76	1434.13	1819.46
	36"(914mm)	WURG-3036-	S	N54	696.06	999.93	733.57	1037.44	875.00	1178.87	1430.02	1853.69	1585.58	2009.25
	42"(1067mm)	WURG-3042-	S	N54	758.70	1083.65	796.32	1121.27	952.14	1277.09	1558.61	2020.62	1737.03	2199.04
	48"(1219mm)	WURG-3048-	S	N54	821.34	1167.37	859.07	1205.10	1029.28	1375.31	1687.20	2187.55	1888.48	2388.83
	54"(1372mm)	WURG-3054-	S	N54	883.98	1251.09	921.82	1288.93	1106.42	1473.53	1815.79	2354.48	2039.93	2578.62
24"(610mm)/30"(762mm)	24"(610mm)	WURG-3024-	S	N45	\$570.78	\$ 832.49	\$608.07	\$ 869.78	\$ 720.72	\$ 982.43	\$1172.84	\$1519.83	\$1282.68	\$1629.67
	30"(762mm)	WURG-3030-	S	N45	633.42	916.21	670.82	953.61	797.86	1080.65	1301.43	1686.76	1434.13	1819.46
	36"(914mm)	WURG-3036-	S	N45	696.06	999.93	733.57	1037.44	875.00	1178.87	1430.02	1853.69	1585.58	2009.25
	42"(1067mm)	WURG-3042-	S	N45	758.70	1083.65	796.32	1121.27	952.14	1277.09	1558.61	2020.62	1737.03	2199.04
	48"(1219mm)	WURG-3048-	S	N45	821.34	1167.37	859.07	1205.10	1029.28	1375.31	1687.20	2187.55	1888.48	2388.83
	54"(1372mm)	WURG-3054-	S	N45	883.98	1251.09	921.82	1288.93	1106.42	1473.53	1815.79	2354.48	2039.93	2578.62
24"(610mm)/30"(762mm)	24"(610mm)	WURG-3024-	S	N45	\$570.78	\$ 832.49	\$608.07	\$ 869.78	\$ 720.72	\$ 982.43	\$1172.84	\$1519.83	\$1282.68	\$1629.67
	30"(762mm)	WURG-3030-	S	N45	633.42	916.21	670.82	953.61	797.86	1080.65	1301.43	1686.76	1434.13	1819.46
	36"(914mm)	WURG-3036-	S	N45	696.06	999.93	733.57	1037.44	875.00	1178.87	1430.02	1853.69	1585.58	2009.25
	42"(1067mm)	WURG-3042-	S	N45	758.70	1083.65	796.32	1121.27	952.14	1277.09	1558.61	2020.62	1737.03	2199.04
	48"(1219mm)	WURG-3048-	S	N45	821.34	1167.37	859.07	1205.10	1029.28	1375.31	1687.20	2187.55	1888.48	2388.83
	54"(1372mm)	WURG-3054-	S	N45	883.98	1251.09	921.82	1288.93	1106.42	1473.53	1815.79	2354.48	2039.93	2578.62
24"(610mm)/30"(762mm)	24"(610mm)	WURG-3024-	S	N45	\$570.78	\$ 832.49	\$608.07	\$ 869.78	\$ 720.72	\$ 982.43	\$1172.84	\$1519.83	\$1282.68	\$1629.67
	30"(762mm)	WURG-3030-	S	N45	633.42	916.21	670.82	953.61	797.86	1080.65	1301.43	1686.76	1434.13	1819.46
	36"(914mm)	WURG-3036-	S	N45	696.06	999.93	733.57	1037.44	875.00	1178.87	1430.02	1853.69	1585.58	2009.25
	42"(1067mm)	WURG-3042-	S	N45	758.70	1083.65	796.32	1121.27	952.14	1277.09	1558.61	2020.62	1737.03	2199.04
	48"(1219mm)	WURG-3048-	S	N45	821.34	1167.37	859.07	1205.10	1029.28	1375.31	1687.20	2187.55	1888.48	2388.83
	54"(1372mm)	WURG-3054-	S	N45	883.98	1251.09	921.82	1288.93	1106.42	1473.53	1815.79	2354.48	2039.93	2578.62
24"(610mm)/30"(762mm)	24"(610mm)	WURG-3024-	S	N45	\$570.78	\$ 832.49	\$608.07	\$ 869.78	\$ 720.72	\$ 982.43	\$1172.84	\$1519.83	\$1282.68	\$1629.67
	30"(762mm)	WURG-3030-	S	N45	633.42	916.21	670.82	953.61	797.86	1080.65	1301.43	1686.76	1434.13	1819.46
	36"(914mm)	WURG-3036-	S	N45	696.06	999.93	733.57	1037.44	875.00	1178.87	1430.02	1853.69	1585.58	2009.25
	42"(1067mm)	WURG-3042-	S	N45	758.70	1083.65	796.32	1121.27	952.14	1277.09	1558.61	2020.62	1737.03	2199.04
	48"(1219mm)	WURG-3048-	S	N45	821.34	1167.37	859.07	1205.10	1029.28	1375.31	1687.20	2187.55	1888.48	2388.83
	54"(1372mm)	WURG-3054-	S	N45	883.98	1251.09	921.82	1288.93	1106.42	1473.53	1815.79	2354.48	2039.93	2578.62
24"(610mm)/30"(762mm)	24"(610mm)	WURG-3024-	S	N45	\$570.78	\$ 832.49	\$608.07	\$ 869.78	\$ 720.72	\$ 982.43	\$1172.84	\$1519.83	\$1282.68	\$1629.67
	30"(762mm)	WURG-3030-	S	N45	633.42	916.21	670.82	953.61	797.86	1080.65	1301.43	1686.76	1434.13	1819.46
	36"(914mm)	WURG-3036-	S	N45	696.06	999.93	733.57	1037.44	875.00	1178.87	1430.02	1853.69	1585.58	2009.25
	42"(1067mm)	WURG-3042-	S	N45	758.70	1083.65	796.32	1121.27	952.14	1277.09	1558.61	2020.62	1737.03	2199.04
	48"(1219mm)	WURG-3048-	S	N45	821.34	1167.37	859.07	1205.10	1029.28	1375.31	1687.20	2187.55	1888.48	2388.83
	54"(1372mm)	WURG-3054-	S	N45	883.98	1251.09	921.82	1288.93	1106.42	1473.53	1815.79	2354.48	2039.93	2578.62

Adaptable Worksurfaces

Rectangular Radius End



(Right-hand orientation)



(Left-hand orientation)

WURR

Features

- Includes work surface and tie plate.
- Laminate with 3mm edgeband (J) or knife edge (F) on user edge and 1mm edgeband on sides and back.
- Wood veneer work surface with 3mm edgeband (K) or knife (U) on user edge and 1mm edgeband on side and back.
- Worksurfaces predrilled to accept most support options.
- Optional wireway along back edge of work surface is color-matched to solid side/back edge trim. When wood veneer or wood grain or patterned laminate is specified, wireway will be Charcoal. Refer to Specification Guide for wireway details.
- **Installed worksurfaces without wireway will not allow clearance for power plug.**
- Depths and widths shown in nominal dimensions.

Specification Tips

- Separately specified floor support required on radius end:
 - Side/corner bracket with work surface support leg or column
- **Work surface support specific to product line and work surface edge guidelines; must be separately specified; refer to Specification Guide for support and load.**
 - Standard cantilever brackets
 - Side/corner brackets
 - Work surface support post or leg - REQUIRED
 - Work surface support panel
 - Attached pedestal (for work surfaces greater than 36”(914mm)-wide)
 - Attached lower storage
- Knife edge requires use of work surface supports for that application; work surface support panel and/or side bracket for use with knife edge.
- Mini cantilever brackets are for use with 18”(457mm) deep work surfaces with knife edge only.
- For work surfaces less than 42”(1067mm) wide, suggested pedestal style is mobile.

Note: Separately specified work surface reinforcement channels provide additional support for work surfaces with 50”(1270mm) spans that are heavily loaded and not otherwise supported by mid-span cantilevers, work surface support panels, posts or attached lower storage.

To Order, Specify:

1) Product number, including:

1 Surface Options:

- L** Laminate
- W** Wood

2 Edge Options:

Laminate:

- J** Edgeband
- F** Knife

Wood:

- K** Edgeband
- U** Knife

3 Wireway Options:

- A** Notched
- C** Without

4 Orientation (as seated):

- R** Right-hand
- L** Left-hand

2) Laminate surface color or Wood finish color.

3) Edge trim color (laminate only).

Depth	Width	Number	Orientation				Laminate A		Laminate B		Laminate E		Wood Group A		Wood Group B	
			1	2	3	4	J	F	J	F	J	F	K	U	K	U
18”(457mm)	24”(610mm)	WURR-1824-	S				\$ 494.03	\$ 724.44	\$ 523.71	\$ 754.12	\$ 613.61	\$ 844.02	\$1005.40	\$1330.56	\$1049.94	\$1375.10
	30”(762mm)	WURR-1830-	S				551.53	795.14	585.05	828.66	686.29	929.90	1123.36	1500.52	1172.82	1549.98
	36”(914mm)	WURR-1836-	S				609.85	869.30	647.21	906.66	759.79	1019.24	1241.32	1680.88	1295.70	1735.26
	42”(1067mm)	WURR-1842-	S				668.17	943.46	709.37	984.66	833.29	1108.58	1359.28	1861.24	1418.58	1920.54
	48”(1219mm)	WURR-1848-	S				726.49	1017.62	771.53	1062.66	906.79	1197.92	1477.24	2041.60	1541.46	2105.82
	54”(1372mm)	WURR-1854-	S				784.81	1091.78	833.69	1140.66	980.29	1287.26	1595.20	2221.96	1664.34	2291.10
24”(610mm)	24”(610mm)	WURR-2424-	S				\$ 505.60	\$ 739.28	\$ 535.28	\$ 768.96	\$ 625.18	\$ 858.86	\$1018.61	\$1351.94	\$1063.15	\$1396.48
	30”(762mm)	WURR-2430-	S				563.10	809.98	596.62	843.50	697.86	944.74	1139.39	1524.72	1188.85	1574.18
	36”(914mm)	WURR-2436-	S				621.42	884.14	658.78	921.50	771.36	1034.08	1260.17	1707.90	1314.55	1762.28
	42”(1067mm)	WURR-2442-	S				679.74	958.30	720.94	999.50	844.86	1123.42	1380.95	1891.08	1440.25	1950.38
	48”(1219mm)	WURR-2448-	S				738.06	1032.46	783.10	1077.50	918.36	1212.76	1501.73	2074.26	1565.95	2138.48
	54”(1372mm)	WURR-2454-	S				796.38	1106.62	845.26	1155.50	991.86	1302.10	1622.51	2257.44	1691.65	2326.58
30”(762mm)	24”(610mm)	WURR-3024-	S				\$ 660.61	\$ 954.53	\$ 690.29	\$ 984.21	\$ 780.19	\$1074.11	\$1233.06	\$1667.64	\$1277.60	\$1712.18
	30”(762mm)	WURR-3030-	S				718.11	1025.23	751.63	1058.75	852.87	1159.99	1356.84	1843.42	1406.30	1892.88
	36”(914mm)	WURR-3036-	S				776.43	1099.39	813.79	1136.75	926.37	1249.33	1480.62	2029.60	1535.00	2083.98
	42”(1067mm)	WURR-3042-	S				834.75	1173.55	875.95	1214.75	999.87	1338.67	1604.40	2215.78	1663.70	2275.08
	48”(1219mm)	WURR-3048-	S				893.07	1247.71	938.11	1292.75	1073.37	1428.01	1728.18	2401.96	1792.40	2466.18
	54”(1372mm)	WURR-3054-	S				951.39	1321.87	1000.27	1370.75	1146.87	1517.35	1851.96	2588.14	1921.10	2657.28
30”(762mm)	60”(1524mm)	WURR-3060-	S				1009.71	1396.03	1062.43	1448.75	1220.37	1606.69	1975.74	2774.32	2049.80	2848.38

Adaptable Worksurfaces

Corner, 90° Straight Front

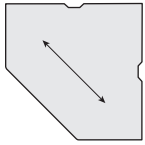
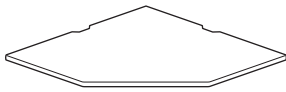

WUCA

Features

- Includes work surface and tie plate.
- Laminate with 3mm edgeband (J) or knife edge (F) on user edge and 1mm edgeband on sides and back.
- Wood veneer work surface with 3mm edgeband (K) or knife (U) on user edge and 1mm edgeband on sides and back.
- Worksurfaces predrilled to accept most support options.
- Optional wireway along back edges of work surface is color-matched to solid side/back edge trim. When wood veneer or wood grain or patterned laminate is specified, wireway will be Charcoal.
- **Installed worksurfaces without wireway will not allow clearance for power plug.**
- Depths and widths shown in nominal dimensions.

Specification Tips

- **Corner bracket is required and must be separately specified.**
- **Work surface support specific to product line and work surface edge guidelines; must be separately specified; refer to Specification Guide for support and load.**
 - Cantilever brackets
 - Corner bracket - REQUIRED
 - Work surface support panel
 - P-leg
- Knife edge requires use of work surface supports for that application; work surface support panel and/or side bracket for use with knife edge.
- Mini cantilever brackets are for use with 18"(457mm) deep work surfaces with knife edge only.
- Recommend the KU4A-0023-█ N or KU3A-0023-█ keyboard pad for 36"(914mm)-wide corners.

To Order, Specify:

1) Product number, including:

1 Surface Options:

- L** Laminate
- W** Wood

2 Edge Options:

Laminate:

- J** Edgeband

- F** Knife

Wood:

- K** Edgeband

- U** Knife

3 Wireway Options:

- A** Notched

- C** Without

2) Laminate surface color or Wood finish color.

3) Edge trim color (laminate only).

Depth	Width	Number	①	②	③	Laminate A		Laminate B		Wood Group A		Wood Group B	
						J	F	J	F	K	U	K	U
18"(457mm)	36"(914mm)	WUCA-3636-█ S N33	█	█	█	\$ 869.11	\$1196.59	\$ 918.36	\$1245.84	\$1274.39	\$1661.07	\$1330.19	\$1716.87
	42"(1067mm)	WUCA-4242-█ S N33	█	█	█	928.87	1288.19	985.69	1345.01	1389.31	1821.16	1473.02	1904.87
	48"(1219mm)	WUCA-4848-█ S N33	█	█	█	1080.55	1471.71	1144.94	1536.10	1596.15	2073.17	1707.77	2184.79
	54"(1372mm)	WUCA-5454-█ S N33	█	█	█	1133.73	1556.73	1205.69	1628.69	N/A	N/A	N/A	N/A
24"(610mm)	36"(914mm)	WUCA-3636-█ S N44	█	█	█	\$ 898.65	\$1226.13	\$ 947.90	\$1275.38	\$1303.93	\$1690.61	\$1359.73	\$1746.41
	42"(1067mm)	WUCA-4242-█ S N44	█	█	█	958.41	1317.73	1015.23	1374.55	1418.85	1850.70	1502.56	1934.41
	48"(1219mm)	WUCA-4848-█ S N44	█	█	█	1110.09	1501.25	1174.48	1565.64	1625.69	2102.71	1737.31	2214.33
	54"(1372mm)	WUCA-5454-█ S N44	█	█	█	1163.27	1586.27	1235.23	1658.23	N/A	N/A	N/A	N/A
30"(762mm)	36"(914mm)	WUCA-3636-█ S N55	█	█	█	\$1023.41	\$1350.89	\$1072.66	\$1400.14	\$1428.69	\$1815.37	\$1484.49	\$1871.17
	42"(1067mm)	WUCA-4242-█ S N55	█	█	█	1083.17	1442.49	1139.99	1499.31	1543.61	1975.46	1627.32	2059.17
	48"(1219mm)	WUCA-4848-█ S N55	█	█	█	1234.85	1626.01	1299.24	1690.40	N/A	N/A	N/A	N/A
	54"(1372mm)	WUCA-5454-█ S N55	█	█	█	1288.03	1711.03	1359.99	1782.99	N/A	N/A	N/A	N/A

Adaptable Worksurfaces

Corner, 90° Wrap-Around

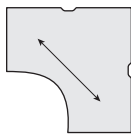

WUCR

Features

- Includes worksurface.
- Laminate with 3mm edgeband (J) or knife edge (F) on user edge and 1mm edgeband on sides and back.
- Wood veneer worksurface with 3mm edgeband (K) or knife (U) on user edge and 1mm edgeband on sides and back.
- Worksurfaces predrilled to accept most support options.
- Optional wireway along back edges of worksurface is color-matched to solid side/back edge trim. When wood veneer or wood grain or patterned laminate is specified, wireway will be Charcoal. Refer to Specification Guide for wireway details.
- **Installed worksurfaces without wireway will not allow clearance for power plug.**
- Depths and widths shown in nominal dimensions.

Specification Tips

- **Corner bracket is required and must be separately specified.**
- **Worksurface support specific to product line and worksurface edge guidelines; must be separately specified; refer to Specification Guide for support and load.**
 - Cantilever brackets
 - Corner bracket - REQUIRED
 - Worksurface support panel
 - P-Leg
- Knife edge requires use of worksurface supports for that application; worksurface support panel and/or side bracket for use with knife edge.
- Mini cantilever brackets are for use with 18”(457mm) deep worksurfaces with knife edge only.
- Recommend the KU4A-0023-■ N or KU3A-0023-■ keyboard pad for 36”(914mm)-wide corners.

To Order, Specify:

1) Product number, including:

1 Surface Options:

- L** Laminate
- W** Wood

2 Edge Options:

Laminate:

- J** Edgeband
- F** Knife

Wood:

- K** Edgeband
- U** Knife

3 Wireway Options:

- A** Notched
- C** Without

2) Laminate surface color or Wood finish color.

3) Edge trim color (laminate only).

Depth	Width	Number	① ② ③			Laminate A		Laminate B		Wood Group A		Wood Group B		
			■	■	■	J	F	J	F	K	U	K	U	
18”(457mm)	36”(914mm)	WUCR-3636-	■	■	■	N33	\$ 732.21	\$1052.72	\$ 779.41	\$1099.92	\$1129.17	\$1507.29	\$1176.81	\$1554.93
	42”(1067mm)	WUCR-4242-	■	■	■	N33	858.69	1198.82	913.99	1254.12	1299.21	1721.85	1377.51	1800.15
	48”(1219mm)	WUCR-4848-	■	■	■	N33	985.17	1344.92	1048.57	1408.32	1469.25	1936.41	1578.21	2045.37
	54”(1372mm)	WUCR-5454-	■	■	■	N33	1111.65	1491.02	1183.15	1562.52	N/A	N/A	N/A	N/A
24”(610mm)	36”(914mm)	WUCR-3636-	■	■	■	N44	\$ 828.73	\$1156.98	\$ 883.59	\$1211.84	\$1230.53	\$1608.65	\$1293.79	\$1671.91
	42”(1067mm)	WUCR-4242-	■	■	■	N44	955.21	1303.08	1018.17	1366.04	1400.57	1823.21	1494.49	1917.13
	48”(1219mm)	WUCR-4848-	■	■	■	N44	1081.69	1449.18	1152.75	1520.24	1570.61	2037.77	1695.19	2162.35
	54”(1372mm)	WUCR-5454-	■	■	■	N44	1208.17	1595.28	1287.33	1674.44	N/A	N/A	N/A	N/A
30”(762mm)	36”(914mm)	WUCR-3636-	■	■	■	N55	\$ 925.25	\$1261.24	\$ 987.77	\$1323.76	\$1331.89	\$1710.01	\$1410.77	\$1788.89
	42”(1067mm)	WUCR-4242-	■	■	■	N55	1051.73	1407.34	1122.35	1477.96	1501.93	1924.57	1611.47	2034.11
	48”(1219mm)	WUCR-4848-	■	■	■	N55	1178.21	1553.44	1256.93	1632.16	N/A	N/A	N/A	N/A
	54”(1372mm)	WUCR-5454-	■	■	■	N55	1304.69	1699.54	1391.51	1786.36	N/A	N/A	N/A	N/A

Adaptable Worksurfaces

Corner, 90° Notched

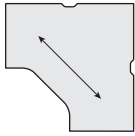

WUCN

Features

- Includes work surface.
- Laminate with 3mm edgeband (J) or knife edge (F) on user edge and 1mm edgeband on sides and back.
- Wood veneer surface with 3mm edgeband (K) or knife (U) on user edge and 1mm edgeband on sides and back.
- Worksurfaces predrilled to accept an adjustable keyboard and most support options.
- Optional wireways along back edges are color-matched to solid side/back edge trim. When wood veneer or wood grain or patterned laminate is specified, wireways will be Charcoal. Refer to Specification Guide for wireway details.
- **Installed worksurfaces without wireway will not allow clearance for power plug.**
- Depths and widths shown in nominal dimensions.

Specification Tips

- **Corner bracket is required and must be separately specified.**
- **Worksurface support specific to product line and work surface edge guidelines; must be separately specified; refer to Specification Guide for support and load.**
 - Cantilever brackets
 - Corner bracket - REQUIRED
 - Worksurface support panel
 - P-Leg
- Knife edge requires use of work surface supports for that application; work surface support panel and/or side bracket for use with knife edge.
- Mini cantilever brackets are for use with 18”(457mm) deep work surfaces with knife edge only.
- Recommend the KU4A-0023-■ N or KU3A-0023-■ keyboard pad for 36”(914mm)-wide corners.

To Order, Specify:

1) Product number, including:

1 Surface Options:

- L Laminate
- W Wood

2 Edge Options:

Laminate:

- J Edgeband

- F Knife

Wood:

- K Edgeband

- U Knife

3 Wireway Options:

- A Notched

- C Without

2) Laminate surface color or Wood finish color.

3) Edge trim color (laminate only).

Depth	Width	Number	① ② ③	Laminate A		Laminate B		Wood Group A		Wood Group B	
				J	F	J	F	K	U	K	U
18”(457mm)	36”(914mm)	WUCN-3636-	■ ■ S N33	\$ 795.49	\$1117.92	\$ 843.78	\$1166.21	\$1212.88	\$1591.37	\$1249.91	\$1628.40
	42”(1067mm)	WUCN-4242-	■ ■ S N33	909.80	1266.48	967.75	1324.43	1386.70	1805.34	1428.53	1847.17
	48”(1219mm)	WUCN-4848-	■ ■ S N33	1025.72	1423.50	1093.33	1491.11	1560.52	2027.34	1607.15	2073.97
	54”(1372mm)	WUCN-5454-	■ ■ S N33	1180.28	1619.16	1257.55	1696.43	N/A	N/A	N/A	N/A
24”(610mm)	36”(914mm)	WUCN-3636-	■ ■ S N44	\$ 821.24	\$1143.67	\$ 869.53	\$1191.96	\$1238.63	\$1617.12	\$1275.66	\$1654.15
	42”(1067mm)	WUCN-4242-	■ ■ S N44	935.55	1292.23	993.50	1350.18	1412.45	1831.09	1454.28	1872.92
	48”(1219mm)	WUCN-4848-	■ ■ S N44	1051.47	1449.25	1119.08	1516.86	1586.27	2053.09	1632.90	2099.72
	54”(1372mm)	WUCN-5454-	■ ■ S N44	1206.03	1644.91	1283.30	1722.18	N/A	N/A	N/A	N/A
30”(762mm)	36”(914mm)	WUCN-3636-	■ ■ S N55	\$ 846.99	\$1169.42	\$ 895.28	\$1217.71	\$1264.38	\$1642.87	\$1301.41	\$1679.90
	42”(1067mm)	WUCN-4242-	■ ■ S N55	961.30	1317.98	1019.25	1375.93	1438.20	1856.84	1480.03	1898.67
	48”(1219mm)	WUCN-4848-	■ ■ S N55	1077.22	1475.00	1144.83	1542.61	N/A	N/A	N/A	N/A
	54”(1372mm)	WUCN-5454-	■ ■ S N55	1231.78	1670.66	1309.05	1747.93	N/A	N/A	N/A	N/A

Adaptable Worksurfaces

Corner, 90° Angled

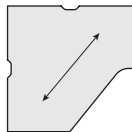

(Left-hand orientation)

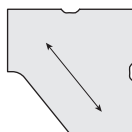

(Right-hand orientation)
WUCU

Features

- Includes worksurface.
- Laminate with 3mm edgeband (J) or knife edge (F) on user edge and 1mm edgeband on back.
- Wood veneer surface with 3mm edgeband (K) or knife (U) on user edge and 1mm edgeband on sides and back.
- Optional wireways along back edges are color-matched to solid side/back edge trim. When wood veneer or wood grain or patterned laminate is specified, wireways will be Charcoal. Refer to Specification Guide for wireway details.
- **Installed worksurfaces without wireway will not allow clearance for power plug.**
- Depths and widths shown in nominal dimensions.

Specification Tips

- **Corner bracket is required and must be separately specified.**
- **Worksurface support specific to product line and worksurface edge guidelines; must be separately specified; refer to Specification Guide for support and load.**
 - Cantilever brackets
 - Corner bracket - REQUIRED
 - Worksurface support panel
 - P-Leg
- Knife edge requires use of worksurface supports for that application; worksurface support panel and/or side bracket for use with knife edge.
- Mini cantilever brackets are for use with 18”(457mm) deep worksurfaces with knife edge only.
- Recommend the KU4A-0023-■ N or KU3A-0023-■ keyboard pad for 36”(914mm)-wide corners.

To Order, Specify:

1) Product number, including:

1 Surface Options:

L Laminate

W Wood

2 Edge Options:

Laminate:

J Edgeband

F Knife

Wood:

K Edgeband

U Knife

3 Wireway Options:

A Notched

C Without

4 Orientation (as seated):

R Right-hand

L Left-hand

2) Laminate surface color or Wood finish color.

3) Edge trim color (laminate only).

Depth	Width	Number	① ② ③ ④				Laminate A		Laminate B		Wood Group A		Wood Group B	
			J	F	J	F	J	F	K	U	K	U		
18”(457mm)	36”(914mm)	WUCU-3636-■ S ■ ■ 33	\$ 832.68	\$ 1096.30	\$ 878.20	\$ 1141.82	\$ 1174.28	\$ 1507.73	\$ 1239.29	\$ 1572.74				
	42”(1067mm)	WUCU-4242-■ S ■ ■ 33	897.91	1218.23	954.17	1274.49	1317.96	1724.67	1423.08	1829.79				
	48”(1219mm)	WUCU-4848-■ S ■ ■ 33	1044.43	1421.45	1111.43	1488.45	1542.93	2022.90	1688.16	2168.13				
	54”(1372mm)	WUCU-5454-■ S ■ ■ 33	1190.95	1624.67	1268.69	1702.41	N/A	N/A	N/A	N/A				
24”(610mm)	36”(914mm)	WUCU-3636-■ S ■ ■ 44	\$ 866.86	\$ 1140.98	\$ 915.10	\$ 1189.22	\$ 1223.28	\$ 1544.69	\$ 1294.89	\$ 1616.30				
	42”(1067mm)	WUCU-4242-■ S ■ ■ 44	932.09	1262.91	991.07	1321.89	1366.96	1761.63	1478.68	1873.35				
	48”(1219mm)	WUCU-4848-■ S ■ ■ 44	1078.61	1466.13	1148.33	1535.85	1591.93	2059.86	1743.76	2211.69				
	54”(1372mm)	WUCU-5454-■ S ■ ■ 44	1225.13	1669.35	1305.59	1749.81	N/A	N/A	N/A	N/A				
30”(762mm)	36”(914mm)	WUCU-3636-■ S ■ ■ 55	\$ 901.04	\$ 1185.66	\$ 952.00	\$ 1236.62	\$ 1272.28	\$ 1581.65	\$ 1350.49	\$ 1659.86				
	42”(1067mm)	WUCU-4242-■ S ■ ■ 55	966.27	1307.59	1027.97	1369.29	1415.96	1798.59	1534.28	1916.91				
	48”(1219mm)	WUCU-4848-■ S ■ ■ 55	1112.79	1510.81	1185.23	1583.25	N/A	N/A	N/A	N/A				
	54”(1372mm)	WUCU-5454-■ S ■ ■ 55	1259.31	1714.03	1342.49	1797.21	N/A	N/A	N/A	N/A				

Adaptable Worksurfaces

Corner 90° Worksurface and Corner 90° Adjustable Split Top

To Create Corner 90° Worksurface Split Top

Corner 90° Worksurface

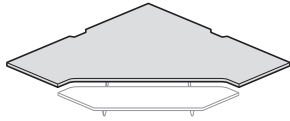

WUCN

Features

- Includes worksurface and tie plate.
- Laminate with 3mm edgeband (J) on user edge and 1mm edgeband on sides and back.
- Worksurfaces predrilled to accept most support options.
- Optional wireway along back edge of worksurface is color-matched to solid side/back edge trim. Refer to Specification Guide for wireway details.
- Worksurfaces have two wireways.
- **Installed worksurfaces without wireway will not allow clearance for power plug.**
- Depths and widths shown in nominal dimensions.

To Order, Specify:

- 1) Product number.
- 2) Laminate surface color.
- 3) Edge trim color.

Specification Tips

- **To create a split top application, an 18" D x 48" W WUCN must be used in conjunction with a WUKC split top. Overall worksurface depth with Split Top is 30" D.**
- **Corner bracket is required and must be separately specified.**
- **Separately specify worksurface supports for the product line and worksurface. Refer to the Specification Guide for support and load guidelines.**

Left/Right Depth	Width	Number	Laminate A J	Laminate B J
Notched				
48"(1219mm)	48"(1219mm)	WUCN-4848-LJSAN33	\$1025.72	\$1093.33
Without Notch				
48"(1219mm)	48"(1219mm)	WUCN-4848-LJSCN33	\$1025.72	\$1093.33

Corner 90° Adjustable Split Top

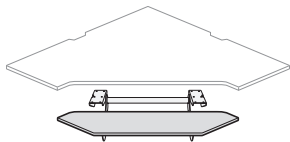

WUKC

Features

- Includes one split corner worksurface with spring mechanism that must be used in conjunction with a corner worksurface for a split top application.
- Laminate with 3mm edgeband (J) on front and rear front edge, and 1mm on back and side edge of front worksurface.
- Spring assist mechanism:
 - Available in charcoal finish color only.
 - Spring assisted adjustment (with manual lock) of 6"(152mm) above worksurface and 6"(152mm) below.
- Depths and widths shown in nominal dimensions.

To Order, Specify:

- 1) Product number.
- 2) Laminate surface color.
- 3) Edge trim color.

Specification Tips

- **To create a split top application, an 18" D x 48" W WUCN must be used in conjunction with a WUKC split top. Overall worksurface depth with Split Top is 30" D.**
- Corner worksurface split top applications are designed to align with adjacent 18"(457mm)-depth worksurfaces; split top is designed to allow pinch point clearance to accommodate cables.
- Not designed for use with adjacent worksurfaces of 24"(610mm) or 30"(762mm) depth.
- Not designed for use on worksurfaces with knife edge.
- Refer to the Specification Guide for application guidelines.

Left/Right Depth	Width	Number	Laminate A J	Laminate B J
12"(305mm)	48"(1219mm)	WUKC-1248-LJSC	\$2374.79	\$2763.33

Adaptable Worksurfaces

Corner, 90° Wrap-Around Transitional

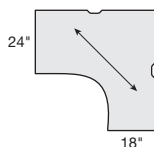
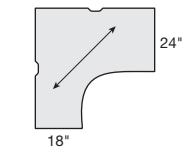

Features

- Includes worksurface.
- Laminate with 3mm edgeband (J) or knife edge (F) on user edge and 1mm edgeband on sides and back.
- Wood veneer worksurface with 3mm edgeband (K) or knife (U) on user edge and 1mm edgeband on sides and back.
- Worksurfaces predrilled to accept most support options.
- Optional wireway along back edges of worksurface is color-matched to solid side/back edge trim. When wood veneer or wood grain or patterned laminate is specified, wireway will be Charcoal. Refer to Specification Guide for wireway details.
- **Installed worksurfaces without wireway will not allow clearance for power plug.**
- Depths and widths shown in nominal dimensions.

Specification Tips

- **Corner bracket is required and must be separately specified.**
- **Worksurface support specific to product line and worksurface edge guidelines; must be separately specified; refer to Specification Guide for support and load.**
 - Cantilever brackets
 - Corner bracket - REQUIRED
 - Worksurface support panel
 - P-Leg
- Knife edge requires use of worksurface supports for that application; worksurface support panel and/or side bracket for use with knife edge.
- Mini cantilever brackets are for use with 18"(457mm) deep worksurfaces with knife edge only.
- Recommend the KU4A-0023- [] N or KU3A-0023- [] keyboard pad for 36"(914mm)-wide corners.

To Order, Specify:

1) Product number, including:

1 Surface Options:

- L** Laminate
- W** Wood

2 Edge Options:

Laminate:

- J** Edgeband
- F** Knife

Wood:

- K** Edgeband
- U** Knife

3 Wireway Options:

- A** Notched
- C** Without

2) Laminate surface color or Wood finish color.

3) Edge trim color (laminate only).

Left/Right Depth	Width	Number	Laminate A		Laminate B		Wood Group A		Wood Group B	
			J	F	J	F	K	U	K	U
18"(457mm)/24"(610mm)	36"(914mm)	WUCT-3636- [] S N34	\$ 780.47	\$ 1104.85	\$ 831.50	\$ 1155.88	\$ 1179.85	\$ 1557.97	\$ 1235.30	\$ 1613.42
	42"(1067mm)	WUCT-4242- [] S N34	906.95	1250.95	966.08	1310.08	1349.89	1772.53	1436.00	1858.64
	48"(1219mm)	WUCT-4848- [] S N34	1033.43	1397.05	1100.66	1464.28	1519.93	1987.09	1636.70	2103.86
	54"(1372mm)	WUCT-5454- [] S N34	1159.91	1543.15	1235.24	1618.48	N/A	N/A	N/A	N/A
24"(610mm)/18"(457mm)	36"(914mm)	WUCT-3636- [] S N43	\$ 780.47	\$ 1104.85	\$ 831.50	\$ 1155.88	\$ 1179.85	\$ 1557.97	\$ 1235.30	\$ 1613.42
	42"(1067mm)	WUCT-4242- [] S N43	906.95	1250.95	966.08	1310.08	1349.89	1772.53	1436.00	1858.64
	48"(1219mm)	WUCT-4848- [] S N43	1033.43	1397.05	1100.66	1464.28	1519.93	1987.09	1636.70	2103.86
	54"(1372mm)	WUCT-5454- [] S N43	1159.91	1543.15	1235.24	1618.48	N/A	N/A	N/A	N/A
24"(610mm)/30"(762mm)	36"(914mm)	WUCT-3636- [] S N45	\$ 876.99	\$ 1209.11	\$ 935.68	\$ 1267.80	\$ 1281.21	\$ 1659.33	\$ 1352.28	\$ 1730.40
	42"(1067mm)	WUCT-4242- [] S N45	1003.47	1355.21	1070.26	1422.00	1451.25	1873.89	1552.98	1975.62
	48"(1219mm)	WUCT-4848- [] S N45	1129.95	1501.31	1204.84	1576.20	N/A	N/A	N/A	N/A
	54"(1372mm)	WUCT-5454- [] S N45	1256.43	1647.41	1339.42	1730.40	N/A	N/A	N/A	N/A
30"(762mm)/24"(610mm)	36"(914mm)	WUCT-3636- [] S N54	\$ 876.99	\$ 1209.11	\$ 935.68	\$ 1267.80	\$ 1281.21	\$ 1659.33	\$ 1352.28	\$ 1730.40
	42"(1067mm)	WUCT-4242- [] S N54	1003.47	1355.21	1070.26	1422.00	1451.25	1873.89	1552.98	1975.62
	48"(1219mm)	WUCT-4848- [] S N54	1129.95	1501.31	1204.84	1576.20	N/A	N/A	N/A	N/A
	54"(1372mm)	WUCT-5454- [] S N54	1256.43	1647.41	1339.42	1730.40	N/A	N/A	N/A	N/A

Adaptable Worksurfaces

Corner, 90° Notched Transitional

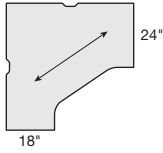

WUCH-N34

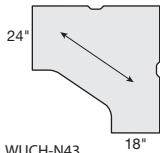

WUCH-N43

Features

- Includes worksurface.
- Laminate with 3mm edgeband (J) or knife edge (F) on user edge and 1mm edgeband on back.
- Wood veneer surface with 3mm edgeband (K) or knife (U) on user edge and 1mm edgeband on sides and back.
- Worksurfaces predrilled to accept an adjustable keyboard and most support options.
- Optional wireways along back edges are color-matched to solid side/back edge trim. When wood veneer or wood grain or patterned laminate is specified, wireways will be Charcoal. Refer to Specification Guide for wireway details.
- **Installed worksurfaces without wireway will not allow clearance for power plug.**
- Depths and widths shown in nominal dimensions.

Specification Tips

- **Corner bracket is required and must be separately specified.**
- **Worksurface support specific to product line and worksurface edge guidelines; must be separately specified; refer to Specification Guide for support and load.**
 - Cantilever brackets
 - Corner bracket - REQUIRED
 - Worksurface support panel
 - P-Leg
- Knife edge requires use of worksurface supports for that application; worksurface support panel and/or side bracket for use with knife edge.
- Mini cantilever brackets are for use with 18”(457mm) deep worksurfaces with knife edge only.
- Recommend the KU4A-0023-■ N or KU3A-0023-■ keyboard pad for 36”(914mm)-wide corners.

To Order, Specify:

1) Product number, including:

1 Surface Options:

- L Laminate
- W Wood

2 Edge Options:

Laminate:

- J Edgeband

- F Knife

Wood:

- K Edgeband

- U Knife

3 Wireway Options:

- A Notched

- C Without

2) Laminate surface color or Wood finish color.

3) Edge trim color (laminate only).

Left/Right Depth	Width	Number	① ② ③	Laminate A		Laminate B		Wood Group A		Wood Group B		
				J	F	J	F	K	U	K	U	
18”(457mm)/24”(610mm)	36”(914mm)	WUCH-3636-	■ ■ S ■	N34	\$ 779.41	\$1101.84	\$ 827.70	\$1150.13	\$1196.80	\$1575.29	\$1233.83	\$1612.32
	42”(1067mm)	WUCH-4242-	■ ■ S ■	N34	893.72	1250.40	951.67	1308.35	1370.62	1789.26	1412.45	1831.09
	48”(1219mm)	WUCH-4848-	■ ■ S ■	N34	1009.64	1407.42	1077.25	1475.03	1544.44	2011.26	1591.07	2057.89
	54”(1372mm)	WUCH-5454-	■ ■ S ■	N34	1164.20	1603.08	1241.47	1680.35	N/A	N/A	N/A	N/A
24”(610mm)/18”(457mm)	36”(914mm)	WUCH-3636-	■ ■ S ■	N43	\$ 779.41	\$1101.84	\$ 827.70	\$1150.13	\$1196.80	\$1575.29	\$1233.83	\$1612.32
	42”(1067mm)	WUCH-4242-	■ ■ S ■	N43	893.72	1250.40	951.67	1308.35	1370.62	1789.26	1412.45	1831.09
	48”(1219mm)	WUCH-4848-	■ ■ S ■	N43	1009.64	1407.42	1077.25	1475.03	1544.44	2011.26	1591.07	2057.89
	54”(1372mm)	WUCH-5454-	■ ■ S ■	N43	1164.20	1603.08	1241.47	1680.35	N/A	N/A	N/A	N/A
24”(610mm)/30”(762mm)	36”(914mm)	WUCH-3636-	■ ■ S ■	N45	\$ 830.91	\$1153.34	\$ 879.20	\$1201.63	\$1248.30	\$1626.79	\$1285.33	\$1663.82
	42”(1067mm)	WUCH-4242-	■ ■ S ■	N45	945.22	1301.90	1003.17	1359.85	1422.12	1840.76	1463.95	1882.59
	48”(1219mm)	WUCH-4848-	■ ■ S ■	N45	1061.14	1458.92	1128.75	1526.53	N/A	N/A	N/A	N/A
	54”(1372mm)	WUCH-5454-	■ ■ S ■	N45	1215.70	1654.58	1292.97	1731.85	N/A	N/A	N/A	N/A
30”(762mm)/24”(610mm)	36”(914mm)	WUCH-3636-	■ ■ S ■	N54	\$ 830.91	\$1153.34	\$ 879.20	\$1201.63	\$1248.30	\$1626.79	\$1285.33	\$1663.82
	42”(1067mm)	WUCH-4242-	■ ■ S ■	N54	945.22	1301.90	1003.17	1359.85	1422.12	1840.76	1463.95	1882.59
	48”(1219mm)	WUCH-4848-	■ ■ S ■	N54	1061.14	1458.92	1128.75	1526.53	N/A	N/A	N/A	N/A
	54”(1372mm)	WUCH-5454-	■ ■ S ■	N54	1215.70	1654.58	1292.97	1731.85	N/A	N/A	N/A	N/A

Adaptable Worksurfaces

Corner, 90° Angled – Transitional

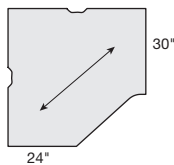

(Left-hand orientation)

WUCF-L45

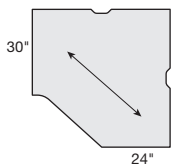

(Right-hand orientation)

WUCF-L54

Features

- Includes worksurface.
- Laminate with 3mm edgeband (J) or knife edge (F) on user edge and 1mm edgeband on sides and back.
- Wood veneer surface with 3mm edgeband (K) or knife edge (U) on user edge and 1mm edgeband on sides and back.
- Optional wireways along back edges are color-matched to solid side/back edge trim. When wood veneer or wood grain or patterned laminate is specified, wireways will be Charcoal. Refer to Specification Guide for wireway details.
- **Installed worksurfaces without wireway will not allow clearance for power plug.**
- Depths and widths shown in nominal dimensions.

Specification Tips

- **Corner bracket is required and must be separately specified.**
- **Worksurface support specific to product line and worksurface edge guidelines; must be separately specified; refer to Specification Guide for support and load.**
 - Cantilever brackets
 - Corner brackets - REQUIRED
 - Worksurface support panel
 - P-Leg
- Knife edge requires use of worksurface supports for that application; worksurface support panel and/or side bracket for use with knife edge.
- Mini cantilever brackets are for use with 18”(457mm) deep worksurfaces with knife edge only.
- Recommend the KU4A-0023-■ N or KU3A-0023-■ keyboard pad for 36”(914mm)-wide corners.

To Order, Specify:

1) Product number, including:

1 Surface Options:

- L** Laminate
- W** Wood

2 Edge Options:

Laminate:

- J** Edgeband
- F** Knife

Wood:

- K** Edgeband
- U** Knife

3 Wireway Options:

- A** Notched
- C** Without

4 Orientation (as seated):

- R** Right-hand
- L** Left-hand

2) Laminate surface color or Wood finish color.

3) Edge trim color (laminate only).

Left/Right Depth	Width	Number	① ② ③ ④				Laminate A		Laminate B		Wood Group A		Wood Group B			
			J	F	J	F	K	U	K	U						
18”(457mm)/24”(610mm)	36”(914mm)	WUCF-3636-	■	■	S	■	■	34	\$ 768.48	\$1037.35	\$ 815.36	\$1084.23	\$1117.49	\$1444.92	\$1185.80	\$1513.23
	42”(1067mm)	WUCF-4242-	■	■	S	■	■	34	915.00	1240.57	972.62	1298.19	1342.46	1743.15	1450.88	1851.57
	48”(1219mm)	WUCF-4848-	■	■	S	■	■	34	1061.52	1443.79	1129.88	1512.15	1567.43	2041.38	1715.96	2189.91
	54”(1372mm)	WUCF-5454-	■	■	S	■	■	34	1208.04	1647.01	1287.14	1726.11	N/A	N/A	N/A	N/A
24”(610mm)/18”(457mm)	36”(914mm)	WUCF-3636-	■	■	S	■	■	43	\$ 768.48	\$1037.35	\$ 815.36	\$1084.23	\$1117.49	\$1444.92	\$1185.80	\$1513.23
	42”(1067mm)	WUCF-4242-	■	■	S	■	■	43	915.00	1240.57	972.62	1298.19	1342.46	1743.15	1450.88	1851.57
	48”(1219mm)	WUCF-4848-	■	■	S	■	■	43	1061.52	1443.79	1129.88	1512.15	1567.43	2041.38	1715.96	2189.91
	54”(1372mm)	WUCF-5454-	■	■	S	■	■	43	1208.04	1647.01	1287.14	1726.11	N/A	N/A	N/A	N/A
24”(610mm)/30”(762mm)	36”(914mm)	WUCF-3636-	■	■	S	■	■	45	\$ 802.66	\$1082.03	\$ 852.26	\$1131.63	\$1166.49	\$1481.88	\$1241.40	\$1556.79
	42”(1067mm)	WUCF-4242-	■	■	S	■	■	45	949.18	1285.25	1009.52	1345.59	1391.46	1780.11	1506.48	1895.13
	48”(1219mm)	WUCF-4848-	■	■	S	■	■	45	1095.70	1488.47	1166.78	1559.55	N/A	N/A	N/A	N/A
	54”(1372mm)	WUCF-5454-	■	■	S	■	■	45	1242.22	1691.69	1324.04	1773.51	N/A	N/A	N/A	N/A
30”(762mm)/24”(610mm)	36”(914mm)	WUCF-3636-	■	■	S	■	■	54	\$ 802.66	\$1082.03	\$ 852.26	\$1131.63	\$1166.49	\$1481.88	\$1241.40	\$1556.79
	42”(1067mm)	WUCF-4242-	■	■	S	■	■	54	949.18	1285.25	1009.52	1345.59	1391.46	1780.11	1506.48	1895.13
	48”(1219mm)	WUCF-4848-	■	■	S	■	■	54	1095.70	1488.47	1166.78	1559.55	N/A	N/A	N/A	N/A
	54”(1372mm)	WUCF-5454-	■	■	S	■	■	54	1242.22	1691.69	1324.04	1773.51	N/A	N/A	N/A	N/A

This page intentionally blank

Adaptable Worksurfaces

Corner, 90° Wrap-Around Extended

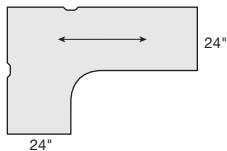

(Right-hand orientation)
WUCE-R44

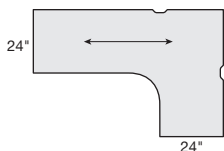

(Left-hand orientation)
WUCE-L44

Features

- Includes worksurface and tie plate.
- Laminate with 3mm edgeband (J) or knife edge (F) on user edge and 1mm edgeband on sides and back.
- Wood veneer worksurface with 3mm edgeband (K) or knife (U) on user edge and 1mm edgeband on sides and back.
- Worksurfaces predrilled to accept most support options.
- Optional wireway along back edge of worksurface is color-matched to solid side/back edge trim. When wood veneer or wood grain or patterned laminate is specified, wireway will be Charcoal. Refer to Specification Guide for wireway details.
- **Installed worksurfaces without wireway will not allow clearance for power plug.**
- Depths and widths shown in nominal dimensions.

Specification Tips

- **Corner bracket is required and must be separately specified.**
- **Worksurface support specific to product line and worksurface edge guidelines; must be separately specified; refer to Specification Guide for support and load.**
 - Cantilever brackets
 - Corner bracket - REQUIRED
 - Worksurface support panel
 - Worksurface support column or leg
 - P-Leg
 - Side brackets
 - Attached lower storage
- Knife edge requires use of worksurface supports for that application; worksurface support panel and/or side bracket for use with knife edge.
- Mini cantilever brackets are for use with 18”(457mm) deep worksurfaces with knife edge only.
- Recommend the KU4A-0023-■ N or KU3A-0023-■ keyboard pad for 36”(914mm)-wide corners.

Note: Separately specified worksurface reinforcement channels provide additional support for worksurfaces with 50”(1270mm) spans that are heavily loaded and not otherwise supported by mid-span cantilevers, worksurface support panels, columns, legs or attached lower storage.

To Order, Specify:

1) Product number, including:

1 Surface Options:

- L** Laminate
- W** Wood

2 Edge Options:

Laminate:

- J** Edgeband
- F** Knife

Wood:

- K** Edgeband
- U** Knife

3 Wireway Options:

- A** Notched
- C** Without

4 Orientation (as seated):

- R** Right-hand
- L** Left-hand

2) Laminate surface color or Wood finish color.

3) Edge trim color (laminate only).

Adaptable Worksurfaces

Corner, 90° Wrap-Around Extended

Left/Right Depth	Width	Length	Number	① ② ③ ④				Laminate A		Laminate B		Wood Group A		Wood Group B	
				J	F	J	F	K	U	K	U				
18"(457mm)	36"(914mm)	42"(1067mm)	WUCE-3642-	S	33	\$1201.28	\$1653.60	\$1273.61	\$1725.93	\$1952.93	\$2504.63	\$2087.53	\$2639.23		
		48"(1219mm)	WUCE-3648-	S	33	1217.05	1685.51	1290.26	1758.72	1969.37	2540.57	2106.95	2678.15		
		54"(1372mm)	WUCE-3654-	S	33	1232.82	1717.42	1306.91	1791.51	1985.81	2576.51	2126.37	2717.07		
		60"(1524mm)	WUCE-3660-	S	33	1248.59	1749.33	1323.56	1824.30	2002.25	2612.45	2145.79	2755.99		
		66"(1676mm)	WUCE-3666-	S	33	1380.56	1897.44	1456.41	1973.29	2207.15	2836.85	2353.67	2983.37		
24"(610mm)	36"(914mm)	72"(1829mm)	WUCE-3672-	S	33	1492.67	2025.69	1569.40	2102.42	2417.05	3066.25	2566.55	3215.75		
		42"(1067mm)	WUCE-3642-	S	44	\$1245.90	\$1698.22	\$1321.81	\$1774.13	\$1994.19	\$2545.89	\$2136.29	\$2687.99		
		48"(1219mm)	WUCE-3648-	S	44	1261.67	1730.13	1338.46	1806.92	2010.63	2581.83	2155.71	2726.91		
		54"(1372mm)	WUCE-3654-	S	44	1277.44	1762.04	1355.11	1839.71	2027.07	2617.77	2175.13	2765.83		
		60"(1524mm)	WUCE-3660-	S	44	1293.21	1793.95	1371.76	1872.50	2043.51	2653.71	2194.55	2804.75		
30"(762mm)	36"(914mm)	66"(1676mm)	WUCE-3666-	S	44	1425.18	1942.06	1504.61	2021.49	2248.41	2878.11	2402.43	3032.13		
		72"(1829mm)	WUCE-3672-	S	44	1537.29	2070.31	1617.60	2150.62	2458.31	3107.51	2615.31	3264.51		
		42"(1067mm)	WUCE-3642-	S	55	\$1478.94	\$1931.26	\$1558.43	\$2010.75	\$2223.87	\$2775.57	\$2373.47	\$2925.17		
		48"(1219mm)	WUCE-3648-	S	55	1494.71	1963.17	1575.08	2043.54	2240.31	2811.51	2392.89	2964.09		
		54"(1372mm)	WUCE-3654-	S	55	1510.48	1995.08	1591.73	2076.33	2256.75	2847.45	2412.31	3003.01		
18"(457mm)	42"(1067mm)	60"(1524mm)	WUCE-3660-	S	55	1526.25	2026.99	1608.38	2109.12	2273.19	2883.39	2431.73	3041.93		
		66"(1676mm)	WUCE-3666-	S	55	1658.22	2175.10	1741.23	2258.11	2478.09	3107.79	2639.61	3269.31		
		72"(1829mm)	WUCE-3672-	S	55	1770.33	2303.35	1854.22	2387.24	2687.99	3337.19	2852.49	3501.69		
		48"(1219mm)	WUCE-4248-	S	33	\$1232.82	\$1717.42	\$1306.91	\$1791.51	\$1985.81	\$2576.51	\$2126.37	\$2717.07		
		54"(1372mm)	WUCE-4254-	S	33	1248.59	1749.33	1323.56	1824.30	2002.25	2612.45	2145.79	2755.99		
24"(610mm)	42"(1067mm)	60"(1524mm)	WUCE-4260-	S	33	1264.36	1781.24	1340.21	1857.09	2018.69	2648.39	2165.21	2794.91		
		66"(1676mm)	WUCE-4266-	S	33	1425.38	1958.40	1502.11	2035.13	2223.59	2872.79	2373.09	3022.29		
		72"(1829mm)	WUCE-4272-	S	33	1537.49	2086.65	1615.10	2164.26	2433.49	3102.19	2585.97	3254.67		
		48"(1219mm)	WUCE-4248-	S	44	\$1277.44	\$1762.04	\$1355.11	\$1839.71	\$2027.07	\$2617.77	\$2175.13	\$2765.83		
		54"(1372mm)	WUCE-4254-	S	44	1293.21	1793.95	1371.76	1872.50	2043.51	2653.71	2194.55	2804.75		
30"(762mm)	42"(1067mm)	60"(1524mm)	WUCE-4260-	S	44	1308.98	1825.86	1388.41	1905.29	2059.95	2689.65	2213.97	2843.67		
		66"(1676mm)	WUCE-4266-	S	44	1470.00	2003.02	1550.31	2083.33	2264.85	2914.05	2421.85	3071.05		
		72"(1829mm)	WUCE-4272-	S	44	1582.11	2131.27	1663.30	2212.46	2474.75	3143.45	2634.73	3303.43		
		48"(1219mm)	WUCE-4248-	S	55	\$1510.48	\$1995.08	\$1591.73	\$2076.33	\$2256.75	\$2847.45	\$2412.31	\$3003.01		
		54"(1372mm)	WUCE-4254-	S	55	1526.25	2026.99	1608.38	2109.12	2273.19	2883.39	2431.73	3041.93		
18"(457mm)	48"(1219mm)	60"(1524mm)	WUCE-4260-	S	55	1542.02	2058.90	1625.03	2141.91	2289.63	2919.33	2451.15	3080.85		
		66"(1676mm)	WUCE-4266-	S	55	1703.04	2236.06	1786.93	2319.95	2494.53	3143.73	2659.03	3308.23		
		72"(1829mm)	WUCE-4272-	S	55	1815.15	2364.31	1899.92	2449.08	2704.43	3373.13	2871.91	3540.61		
		54"(1372mm)	WUCE-4854-	S	33	\$1264.36	\$1781.24	\$1340.21	\$1857.09	\$2018.69	\$2648.39	\$2165.21	\$2794.91		
		60"(1524mm)	WUCE-4860-	S	33	1280.13	1813.15	1356.86	1889.88	2035.13	2684.33	2184.63	2833.83		
24"(610mm)	48"(1219mm)	66"(1676mm)	WUCE-4866-	S	33	1470.20	2019.36	1547.81	2096.97	2240.03	2908.73	2392.51	3061.21		
		72"(1829mm)	WUCE-4872-	S	33	1582.31	2147.61	1660.80	2226.10	2449.93	3138.13	2605.39	3293.59		
		54"(1372mm)	WUCE-4854-	S	44	\$1308.98	\$1825.86	\$1388.41	\$1905.29	\$2059.95	\$2689.65	\$2213.97	\$2843.67		
		60"(1524mm)	WUCE-4860-	S	44	1324.75	1857.77	1405.06	1938.08	2076.39	2725.59	2233.99	2882.59		
		66"(1676mm)	WUCE-4866-	S	44	1514.82	2063.98	1596.01	2145.17	2281.29	2949.99	2441.27	3109.97		
30"(762mm)	48"(1219mm)	72"(1829mm)	WUCE-4872-	S	44	1626.93	2192.23	1709.00	2274.30	2491.19	3179.39	2654.15	3342.35		
		60"(1524mm)	WUCE-4860-	S	55	\$1542.02	\$2058.90	\$1625.03	\$2141.91	\$2289.63	\$2919.33	\$2451.15	\$3080.85		
		66"(1676mm)	WUCE-4866-	S	55	1557.79	2090.81	1641.68	2174.70	2306.07	2955.27	2470.57	3119.77		
		72"(1829mm)	WUCE-4872-	S	55	1747.86	2297.02	1832.63	2381.79	2510.97	3179.67	2678.45	3347.15		
		72"(1829mm)	WUCE-4872-	S	55	1859.97	2425.27	1945.62	2510.92	2720.87	3409.07	2891.33	3579.53		
18"(457mm)	54"(1372mm)	60"(1524mm)	WUCE-5460-	S	33	\$1295.90	\$1845.06	\$1373.51	\$1922.67	N/A	N/A	N/A	N/A		
		66"(1676mm)	WUCE-5466-	S	33	1515.02	2080.32	1593.51	2158.81	N/A	N/A	N/A	N/A		
		72"(1829mm)	WUCE-5472-	S	33	1627.13	2208.57	1706.50	2287.94	N/A	N/A	N/A	N/A		
24"(610mm)	54"(1372mm)	60"(1524mm)	WUCE-5460-	S	44	\$1340.52	\$1889.68	\$1421.71	\$1970.87	N/A	N/A	N/A	N/A		
		66"(1676mm)	WUCE-5466-	S	44	1559.64	2124.94	1641.71	2207.01	N/A	N/A	N/A	N/A		
		72"(1829mm)	WUCE-5472-	S	44	1671.75	2253.19	1754.70	2336.14	N/A	N/A	N/A	N/A		
30"(762mm)	54"(1372mm)	60"(1524mm)	WUCE-5460-	S	55	\$1573.56	\$2122.72	\$1658.33	\$2207.49	N/A	N/A	N/A	N/A		
		66"(1676mm)	WUCE-5466-	S	55	1792.68	2357.98	1878.33	2443.63	N/A	N/A	N/A	N/A		
		72"(1829mm)	WUCE-5472-	S	55	1904.79	2486.23	1991.32	2572.76	N/A	N/A	N/A	N/A		
18"(457mm)	60"(1524mm)	66"(1676mm)	WUCE-6066-	S	33	\$1559.84	\$2141.28	\$1639.21	\$2220.65	N/A	N/A	N/A	N/A		
		72"(1829mm)	WUCE-6072-	S	33	1671.95	2269.53	1752.20	2349.78	N/A	N/A	N/A	N/A		
24"(610mm)	60"(1524mm)	66"(1676mm)	WUCE-6066-	S	44	\$1604.46	\$2185.90	\$1687.41	\$2268.85	N/A	N/A	N/A	N/A		
		72"(1829mm)	WUCE-6072-	S	44	1716.57	2314.15	1800.40	2397.98	N/A	N/A	N/A	N/A		
30"(762mm)	60"(1524mm)	66"(1676mm)	WUCE-6066-	S	55	\$1837.50	\$2418.94	\$1924.03	\$2505.47	N/A	N/A	N/A	N/A		
		72"(1829mm)	WUCE-6072-	S	55	1949.61	2547.19	2037.02	2634.60	N/A	N/A	N/A	N/A		

Adaptable Worksurfaces

Corner, 90° Notched Extended

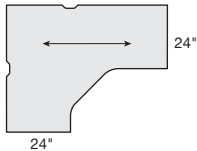
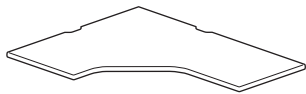

(Right-hand orientation)

WUCP-R44

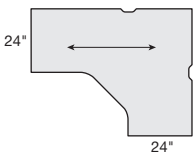

(Left-hand orientation)

WUCP-L44

Features

- Includes worksurface and tie plate.
- Laminate with 3mm edgeband (J) or knife edge (F) on user edge and 1mm edgeband on sides and back.
- Wood veneer worksurface with 3mm edgeband (K) or knife (U) on user edge and 1mm edgeband on sides and back.
- Worksurfaces predrilled to accept most support options.
- Optional wireways along back edges are color-matched to solid side/back edge trim. When wood veneer or wood grain or patterned laminate is specified, wireways will be Charcoal. Refer to Specification Guide for wireway details.
- **Installed worksurfaces without wireway will not allow clearance for power plug.**
- Depths and widths shown in nominal dimensions.

Specification Tips

- **Corner bracket is required and must be separately specified.**
- **Worksurface support specific to product line and worksurface edge guidelines; must be separately specified; refer to Specification Guide for support and load.**
 - Cantilever brackets
 - Corner bracket - REQUIRED
 - Worksurface support panel
 - Support post or support column
 - Disc base
 - Double support leg
 - P-Leg
 - Side brackets
- Knife edge requires use of worksurface supports for that application; worksurface support panel and/or side bracket for use with knife edge.
- Mini cantilever brackets are for use with 18”(457mm) deep worksurfaces with knife edge only.
- Recommend the KU4A-0023-■ N or KU3A-0023-■ ■ keyboard pad for 36”(914mm)-wide corners.

Note: Separately specified worksurface reinforcement channels provide additional support for worksurfaces with 50”(1270mm) spans that are heavily loaded and not otherwise supported by mid-span cantilevers, worksurface end panels, legs or attached storage.

To Order, Specify:

1) Product number, including:

1 Surface Options:

L Laminate

W Wood

2 Edge Options:

Laminate:

J Edgeband

F Knife

Wood:

K Edgeband

U Knife

3 Wireway Options:

A Notched

C Without

4 Orientation (as seated):

R Right-hand

L Left-hand

2) Laminate surface color or Wood finish color.

3) Edge trim color (laminated only).

Adaptable Worksurfaces

Corner, 90° Notched Extended

Left/Right Depth	Width	Length	Number	① ② ③ ④				Laminate A		Laminate B		Wood Group A		Wood Group B	
				J	F	J	F	K	U	K	U				
18"(457mm)	36"(914mm)	42"(1067mm)	WUCP-3642-	S	33	\$1296.73	\$1747.33	\$1380.46	\$1831.06	\$1894.24	\$2441.82	\$2020.64	\$2568.22		
		48"(1219mm)	WUCP-3648-	S	33	1329.56	1796.40	1415.51	1882.35	1952.53	2525.11	2089.28	2661.86		
		54"(1372mm)	WUCP-3654-	S	33	1362.39	1845.47	1450.56	1933.64	2010.82	2608.40	2157.92	2755.50		
		60"(1524mm)	WUCP-3660-	S	33	1395.22	1894.54	1485.61	1984.93	2069.11	2691.69	2226.56	2849.14		
		66"(1676mm)	WUCP-3666-	S	33	1428.05	1943.61	1520.66	2036.22	2127.40	2774.98	2295.20	2942.78		
24"(610mm)	36"(914mm)	72"(1829mm)	WUCP-3672-	S	33	1639.81	2171.61	1734.64	2266.44	2364.62	3037.20	2542.77	3215.35		
		42"(1067mm)	WUCP-3642-	S	44	\$1333.82	\$1784.42	\$1420.53	\$1871.13	\$1923.70	\$2471.28	\$2055.33	\$2602.91		
		48"(1219mm)	WUCP-3648-	S	44	1366.65	1833.49	1455.58	1922.42	1981.99	2554.57	2123.97	2696.55		
		54"(1372mm)	WUCP-3654-	S	44	1399.48	1882.56	1490.63	1973.71	2040.28	2637.86	2192.61	2790.19		
		60"(1524mm)	WUCP-3660-	S	44	1432.31	1931.63	1525.68	2025.00	2098.57	2721.15	2261.25	2883.83		
30"(762mm)	36"(914mm)	66"(1676mm)	WUCP-3666-	S	44	1465.14	1980.70	1560.73	2076.29	2156.86	2804.44	2329.89	2977.47		
		72"(1829mm)	WUCP-3672-	S	44	1676.90	2208.70	1774.71	2306.51	2394.08	3066.66	2577.46	3250.04		
		42"(1067mm)	WUCP-3642-	S	55	\$1370.91	\$1821.51	\$1460.60	\$1911.20	\$1953.16	\$2500.74	\$2090.02	\$2637.60		
		48"(1219mm)	WUCP-3648-	S	55	1403.74	1870.58	1495.65	1962.49	2011.45	2584.03	2158.66	2731.24		
		54"(1372mm)	WUCP-3654-	S	55	1436.57	1919.65	1530.70	2013.78	2069.74	2667.32	2227.30	2824.88		
18"(457mm)	42"(1067mm)	60"(1524mm)	WUCP-3660-	S	55	1469.40	1968.72	1565.75	2065.07	2128.03	2750.61	2295.94	2918.52		
		66"(1676mm)	WUCP-3666-	S	55	1502.23	2017.79	1600.80	2116.36	2186.32	2833.90	2364.58	3012.16		
		72"(1829mm)	WUCP-3672-	S	55	1713.99	2245.79	1814.78	2346.58	2423.54	3096.12	2612.15	3284.73		
		48"(1219mm)	WUCP-4248-	S	33	\$1362.39	\$1845.47	\$1450.56	\$1933.64	\$2010.82	\$2608.40	\$2157.92	\$2755.50		
		54"(1372mm)	WUCP-4254-	S	33	1395.22	1894.54	1485.61	1984.93	2069.11	2691.69	2226.56	2849.14		
24"(610mm)	42"(1067mm)	60"(1524mm)	WUCP-4260-	S	33	1428.05	1943.61	1520.66	2036.22	2127.40	2774.98	2295.20	2942.78		
		66"(1676mm)	WUCP-4266-	S	33	1460.88	1992.68	1555.71	2087.51	2185.69	2858.27	2363.84	3036.42		
		72"(1829mm)	WUCP-4272-	S	33	1672.64	2220.68	1769.69	2317.73	2422.91	3120.49	2611.41	3308.99		
		48"(1219mm)	WUCP-4248-	S	44	\$1399.48	\$1882.56	\$1490.63	\$1973.71	\$2040.28	\$2637.86	\$2192.61	\$2790.19		
		54"(1372mm)	WUCP-4254-	S	44	1432.31	1931.63	1525.68	2025.00	2098.57	2721.15	2261.25	2883.83		
30"(762mm)	42"(1067mm)	60"(1524mm)	WUCP-4260-	S	44	1465.14	1980.70	1560.73	2076.29	2156.86	2804.44	2329.89	2977.47		
		66"(1676mm)	WUCP-4266-	S	44	1497.97	2029.77	1595.78	2127.58	2215.15	2887.73	2398.53	3071.11		
		72"(1829mm)	WUCP-4272-	S	44	1709.73	2257.77	1809.76	2357.80	2452.37	3149.95	2646.10	3343.68		
		48"(1219mm)	WUCP-4248-	S	55	\$1436.57	\$1919.65	\$1530.70	\$2013.78	\$2069.74	\$2667.32	\$2227.30	\$2824.88		
		54"(1372mm)	WUCP-4254-	S	55	1469.40	1968.72	1565.75	2065.07	2128.03	2750.61	2295.94	2918.52		
18"(457mm)	48"(1219mm)	60"(1524mm)	WUCP-4260-	S	55	1502.23	2017.79	1600.80	2116.36	2186.32	2833.90	2364.58	3012.16		
		66"(1676mm)	WUCP-4266-	S	55	1535.06	2066.86	1635.85	2167.65	2244.61	2917.19	2433.22	3105.80		
		72"(1829mm)	WUCP-4272-	S	55	1746.82	2294.86	1849.83	2397.87	2481.83	3179.41	2680.79	3378.37		
		54"(1372mm)	WUCP-4854-	S	33	\$1428.05	\$1943.61	\$1520.66	\$2036.22	\$2127.40	\$2774.98	\$2295.20	\$2942.78		
		60"(1524mm)	WUCP-4860-	S	33	1460.88	1992.68	1555.71	2087.51	2185.69	2858.27	2363.84	3036.42		
24"(610mm)	48"(1219mm)	66"(1676mm)	WUCP-4866-	S	33	1493.71	2041.75	1590.76	2138.80	2243.98	2941.56	2432.48	3130.06		
		72"(1829mm)	WUCP-4872-	S	33	1705.47	2269.75	1804.74	2369.02	2481.20	3203.78	2680.05	3402.63		
		54"(1372mm)	WUCP-4854-	S	44	\$1465.14	\$1980.70	\$1560.73	\$2076.29	\$2156.86	\$2804.44	\$2329.89	\$2977.47		
		60"(1524mm)	WUCP-4860-	S	44	1497.97	2029.77	1595.78	2127.58	2215.15	2887.73	2398.53	3071.11		
		66"(1676mm)	WUCP-4866-	S	44	1530.80	2078.84	1630.83	2178.87	2273.44	2971.02	2467.17	3164.75		
30"(762mm)	48"(1219mm)	72"(1829mm)	WUCP-4872-	S	44	1742.56	2306.84	1844.81	2409.09	2510.66	3233.24	2714.74	3437.32		
		60"(1524mm)	WUCP-4860-	S	55	\$1502.23	\$2017.79	\$1600.80	\$2116.36	\$2186.32	\$2833.90	\$2364.58	\$3012.16		
		66"(1676mm)	WUCP-4866-	S	55	1535.06	2066.86	1635.85	2167.65	2244.61	2917.19	2433.22	3105.80		
		72"(1829mm)	WUCP-4872-	S	55	1779.65	2343.93	1884.88	2449.16	2540.12	3262.70	2749.43	3472.01		
		60"(1524mm)	WUCP-5460-	S	33	\$1493.71	\$2041.75	\$1590.76	\$2138.80	N/A	N/A	N/A	N/A		
18"(457mm)	54"(1372mm)	66"(1676mm)	WUCP-5466-	S	33	1526.54	2090.82	1625.81	2190.09	N/A	N/A	N/A	N/A		
		72"(1829mm)	WUCP-5472-	S	33	1738.30	2318.82	1839.79	2420.31	N/A	N/A	N/A	N/A		
		24"(610mm)	54"(1372mm)	60"(1524mm)	WUCP-5460-	S	44	\$1530.80	\$2078.84	\$1630.83	\$2178.87	N/A	N/A	N/A	N/A
		66"(1676mm)	WUCP-5466-	S	44	1563.63	2127.91	1665.88	2230.16	N/A	N/A	N/A	N/A		
		72"(1829mm)	WUCP-5472-	S	44	1775.39	2355.91	1879.86	2460.38	N/A	N/A	N/A	N/A		
30"(762mm)	54"(1372mm)	60"(1524mm)	WUCP-5460-	S	55	\$1567.89	\$2115.93	\$1670.90	\$2218.94	N/A	N/A	N/A	N/A		
		66"(1676mm)	WUCP-5466-	S	55	1600.72	2165.00	1705.95	2270.23	N/A	N/A	N/A	N/A		
		72"(1829mm)	WUCP-5472-	S	55	1812.48	2393.00	1919.93	2500.45	N/A	N/A	N/A	N/A		
18"(457mm)	60"(1524mm)	66"(1676mm)	WUCP-6066-	S	33	\$1559.37	\$2139.89	\$1660.86	\$2241.38	N/A	N/A	N/A	N/A		
		72"(1829mm)	WUCP-6072-	S	33	1771.13	2367.89	1874.84	2471.60	N/A	N/A	N/A	N/A		
24"(610mm)	60"(1524mm)	66"(1676mm)	WUCP-6066-	S	44	\$1596.46	\$2176.98	\$1700.93	\$2281.45	N/A	N/A	N/A	N/A		
		72"(1829mm)	WUCP-6072-	S	44	1808.22	2404.98	1914.91	2511.67	N/A	N/A	N/A	N/A		
		30"(762mm)	60"(1524mm)	66"(1676mm)	WUCP-6066-	S	55	\$1633.55	\$2214.07	\$1741.00	\$2321.52	N/A	N/A	N/A	N/A
		72"(1829mm)	WUCP-6072-	S	55	1845.31	2442.07	1954.98	2551.74	N/A	N/A	N/A	N/A		

This page intentionally blank

Adaptable Worksurfaces

Corner, 90° Wrap-Around Transitional Extended

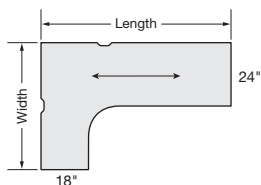

(Right-hand orientation)

WUCX-R34

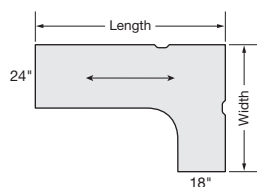

(Left-hand orientation)

WUCX-L43

Features

- Includes worksurface and tie plate.
- Laminate with 3mm edgeband (J) or knife edge (F) on user edge and 1mm edgeband on sides and back.
- Wood veneer worksurface with 3mm edgeband (K) of knife (U) on user edge and 1mm edgeband on sides and back.
- Worksurfaces predrilled to accept most support options.
- Optional wireway along back edges of worksurface is color-matched to solid side/back edge trim. When wood veneer or wood grain or patterned laminate is specified, wireway will be Charcoal. Refer to Specification Guide for wireway details.
- **Installed worksurfaces without wireway will not allow clearance for power plug.**
- Depths and widths shown in nominal dimensions.

Specification Tips

- **Corner bracket is required and must be separately specified.**
- **Worksurface support specific to product line and worksurface edge guidelines; must be separately specified; refer to Specification Guide for support and load.**
 - Cantilever brackets
 - Corner bracket - REQUIRED
 - Worksurface support panel
 - Support post or support column
 - P-Leg
 - Side brackets
 - Attached lower storage
- Knife edge requires use of worksurface supports for that application; worksurface support panel and/or side bracket for use with knife edge.
- Mini cantilever brackets are for use with 18"(457mm) deep worksurfaces with knife edge only.
- Recommend the KU4A-0023-■ N or KU3A-0023-■ keyboard pad for 36"(914mm)-wide corners.
- Intermediate support is required for unsupported worksurface span greater than 60"(1524mm).

Note: Separately specified worksurface reinforcement channels provide additional support for worksurfaces with 50"(1270mm) spans that are heavily loaded and not otherwise supported by mid-span cantilevers, worksurface support panels, columns, legs or attached lower storage.

To Order, Specify:

1) Product number, including:

1 Surface Options:

L Laminate

W Wood

2 Edge Options:

Laminate:

J Edgeband

F Knife

Wood:

K Edgeband

U Knife

3 Wireway Options:

A Notched

C Without

4 Orientation (as seated):

R Right-hand

L Left-hand

2) Laminate surface color or Wood finish color.

3) Edge trim color (laminates only).

Adaptable Worksurfaces

Corner, 90° Wrap-Around Transitional Extended

Left/Right Depth	Width	Length	Number	① ② ③ ④				Laminate A		Laminate B		Wood Group A		Wood Group B			
				J	F	J	F	K	U	K	U						
18"(457mm)/24"(66mm)	36"(914mm)	42"(1067mm)	WUCX-3642-		S		34	\$1354.82	\$1807.14	\$1428.94	\$1881.26	\$2192.26	\$2743.96	\$2330.61	\$2882.31		
		48"(1219mm)	WUCX-3648-		S		34	1370.59	1839.05	1445.59	1914.05	2208.70	2779.90	2350.03	2921.23		
		54"(1372mm)	WUCX-3654-		S		34	1386.36	1870.96	1462.24	1946.84	2225.14	2815.84	2369.45	2960.15		
		60"(1524mm)	WUCX-3660-		S		34	1402.13	1902.87	1478.89	1979.63	2241.58	2851.78	2388.87	2999.07		
		66"(1676mm)	WUCX-3666-		S		34	1534.10	2050.98	1611.74	2128.62	2446.48	3076.18	2596.75	3226.45		
		72"(1829mm)	WUCX-3672-		S		34	1646.21	2179.23	1724.73	2257.75	2656.38	3305.58	2809.63	3458.83		
24"(610mm)/18"(457mm)	36"(914mm)	42"(1067mm)	WUCX-3642-		S		43	\$1354.82	\$1807.14	\$1428.94	\$1881.26	\$2192.26	\$2743.96	\$2330.61	\$2882.31		
		48"(1219mm)	WUCX-3648-		S		43	1370.59	1839.05	1445.59	1914.05	2208.70	2779.90	2350.03	2921.23		
		54"(1372mm)	WUCX-3654-		S		43	1386.36	1870.96	1462.24	1946.84	2225.14	2815.84	2369.45	2960.15		
		60"(1524mm)	WUCX-3660-		S		43	1402.13	1902.87	1478.89	1979.63	2241.58	2851.78	2388.87	2999.07		
		66"(1676mm)	WUCX-3666-		S		43	1534.10	2050.98	1611.74	2128.62	2446.48	3076.18	2596.75	3226.45		
		72"(1829mm)	WUCX-3672-		S		43	1646.21	2179.23	1724.73	2257.75	2656.38	3305.58	2809.63	3458.83		
24"(610mm)/30"(762mm)	36"(914mm)	42"(1067mm)	WUCX-3642-		S		45	\$1399.44	\$1851.76	\$1477.14	\$1929.46	\$2233.52	\$2785.22	\$2379.37	\$2931.07		
		48"(1219mm)	WUCX-3648-		S		45	1415.21	1883.67	1493.79	1962.25	2249.96	2821.16	2398.79	2969.99		
		54"(1372mm)	WUCX-3654-		S		45	1430.98	1915.58	1510.44	1995.04	2266.40	2857.10	2418.21	3008.91		
		60"(1524mm)	WUCX-3660-		S		45	1446.75	1947.49	1527.09	2027.83	2282.84	2893.04	2437.63	3047.83		
		66"(1676mm)	WUCX-3666-		S		45	1578.72	2095.60	1659.94	2176.82	2487.74	3117.44	2645.51	3275.21		
		72"(1829mm)	WUCX-3672-		S		45	1690.83	2223.85	1772.93	2305.95	2697.64	3346.84	2858.39	3507.59		
30"(762mm)/24"(610mm)	36"(914mm)	42"(1067mm)	WUCX-3642-		S		54	\$1399.44	\$1851.76	\$1477.14	\$1929.46	\$2233.52	\$2785.22	\$2379.37	\$2931.07		
		48"(1219mm)	WUCX-3648-		S		54	1415.21	1883.67	1493.79	1962.25	2249.96	2821.16	2398.79	2969.99		
		54"(1372mm)	WUCX-3654-		S		54	1430.98	1915.58	1510.44	1995.04	2266.40	2857.10	2418.21	3008.91		
		60"(1524mm)	WUCX-3660-		S		54	1446.75	1947.49	1527.09	2027.83	2282.84	2893.04	2437.63	3047.83		
		66"(1676mm)	WUCX-3666-		S		54	1578.72	2095.60	1659.94	2176.82	2487.74	3117.44	2645.51	3275.21		
		72"(1829mm)	WUCX-3672-		S		54	1690.83	2223.85	1772.93	2305.95	2697.64	3346.84	2858.39	3507.59		
18"(457mm)/24"(610mm)	42"(1067mm)	48"(1219mm)	WUCX-4248-		S		34	\$1386.36	\$1870.96	\$1462.24	\$1946.84	\$2225.14	\$2815.84	\$2369.45	\$2960.15		
		54"(1372mm)	WUCX-4254-		S		34	1402.13	1902.87	1478.89	1979.63	2241.58	2851.78	2388.87	2999.07		
		60"(1524mm)	WUCX-4260-		S		34	1417.90	1934.78	1495.54	2012.42	2258.02	2887.72	2408.29	3037.99		
		66"(1676mm)	WUCX-4266-		S		34	1578.92	2111.94	1657.44	2190.46	2462.92	3112.12	2616.17	3265.37		
		72"(1829mm)	WUCX-4272-		S		34	1691.03	2240.19	1770.43	2319.59	2672.82	3341.52	2829.05	3497.75		
		24"(610mm)/18"(457mm)	42"(1067mm)	48"(1219mm)	WUCX-4248-		S		43	\$1386.36	\$1870.96	\$1462.24	\$1946.84	\$2225.14	\$2815.84	\$2369.45	\$2960.15
54"(1372mm)	WUCX-4254-				S		43	1402.13	1902.87	1478.89	1979.63	2241.58	2851.78	2388.87	2999.07		
60"(1524mm)	WUCX-4260-				S		43	1417.90	1934.78	1495.54	2012.42	2258.02	2887.72	2408.29	3037.99		
66"(1676mm)	WUCX-4266-				S		43	1578.92	2111.94	1657.44	2190.46	2462.92	3112.12	2616.17	3265.37		
72"(1829mm)	WUCX-4272-				S		43	1691.03	2240.19	1770.43	2319.59	2672.82	3341.52	2829.05	3497.75		
24"(610mm)/30"(762mm)	42"(1067mm)			48"(1219mm)	WUCX-4248-		S		45	\$1430.98	\$1915.58	\$1510.44	\$1995.04	\$2266.40	\$2857.10	\$2418.21	\$3008.91
		54"(1372mm)	WUCX-4254-		S		45	1446.75	1947.49	1527.09	2027.83	2282.84	2893.04	2437.63	3047.83		
		60"(1524mm)	WUCX-4260-		S		45	1462.52	1979.40	1543.74	2060.62	2299.28	2928.98	2457.05	3086.75		
		66"(1676mm)	WUCX-4266-		S		45	1623.54	2156.56	1705.64	2238.66	2504.18	3153.38	2664.93	3314.13		
		72"(1829mm)	WUCX-4272-		S		45	1735.65	2284.81	1818.63	2367.79	2714.08	3382.78	2877.81	3546.51		
		30"(762mm)/24"(610mm)	42"(1067mm)	48"(1067mm)	WUCX-4248-		S		54	\$1430.98	\$1915.58	\$1510.44	\$1995.04	\$2266.40	\$2857.10	\$2418.21	\$3008.91
54"(1372mm)	WUCX-4254-				S		54	1446.75	1947.49	1527.09	2027.83	2282.84	2893.04	2437.63	3047.83		
60"(1524mm)	WUCX-4260-				S		54	1462.52	1979.40	1543.74	2060.62	2299.28	2928.98	2457.05	3086.75		
66"(1676mm)	WUCX-4266-				S		54	1623.54	2156.56	1705.64	2238.66	2504.18	3153.38	2664.93	3314.13		
72"(1829mm)	WUCX-4272-				S		54	1735.65	2284.81	1818.63	2367.79	2714.08	3382.78	2877.81	3546.51		
18"(457mm)/24"(610mm)	48"(1219mm)			54"(1372mm)	WUCX-4854-		S		34	\$1417.90	\$1934.78	\$1495.54	\$2012.42	\$2258.02	\$2887.72	\$2408.29	\$3037.99
		60"(1524mm)	WUCX-4860-		S		34	1433.67	1966.69	1512.19	2045.21	2274.46	2923.66	2427.71	3076.91		
		66"(1676mm)	WUCX-4866-		S		34	1623.74	2172.90	1703.14	2252.30	2479.36	3148.06	2635.59	3304.29		
		72"(1829mm)	WUCX-4872-		S		34	1735.85	2301.15	1816.13	2381.43	2689.26	3377.46	2848.47	3536.67		
		24"(610mm)/18"(457mm)	48"(1219mm)	54"(1372mm)	WUCX-4854-		S		43	\$1417.90	\$1934.78	\$1495.54	\$2012.42	\$2258.02	\$2887.72	\$2408.29	\$3037.99
				60"(1524mm)	WUCX-4860-		S		43	1433.67	1966.69	1512.19	2045.21	2274.46	2923.66	2427.71	3076.91
66"(1676mm)	WUCX-4866-				S		43	1623.74	2172.90	1703.14	2252.30	2479.36	3148.06	2635.59	3304.29		
72"(1829mm)	WUCX-4872-				S		43	1735.85	2301.15	1816.13	2381.43	2689.26	3377.46	2848.47	3536.67		
24"(610mm)/30"(762mm)	48"(1219mm)			54"(1372mm)	WUCX-4854-		S		45	\$1462.52	\$1979.40	\$1543.74	\$2060.62	\$2299.28	\$2928.98	\$2457.05	\$3086.75
				60"(1524mm)	WUCX-4860-		S		45	1478.29	2011.31	1560.39	2093.41	2315.72	2964.92	2476.47	3125.67
		66"(1676mm)	WUCX-4866-		S		45	1668.36	2217.52	1751.34	2300.50	2520.62	3189.32	2684.35	3353.05		
		72"(1829mm)	WUCX-4872-		S		45	1780.47	2345.77	1864.33	2429.63	2730.52	3418.72	2897.23	3585.43		
		30"(762mm)/24"(610mm)	48"(1219mm)	54"(1372mm)	WUCX-4854-		S		54	\$1462.52	\$1979.40	\$1543.74	\$2060.62	\$2299.28	\$2928.98	\$2457.05	\$3086.75
				60"(1524mm)	WUCX-4860-		S		54	1478.29	2011.31	1560.39	2093.41	2315.72	2964.92	2476.47	3125.67
66"(1676mm)	WUCX-4866-				S		54	1668.36	2217.52	1751.34	2300.50	2520.62	3189.32	2684.35	3353.05		
72"(1829mm)	WUCX-4872-				S		54	1780.47	2345.77	1864.33	2429.63	2730.52	3418.72	2897.23	3585.43		

Adaptable Worksurfaces

Corner, 90° Wrap-Around Transitional Extended

Left/Right Depth	Width	Length	Number	① ② ③ ④				Laminate A		Laminate B		Wood Group A		Wood Group B	
				J	F	J	F	K	U	K	U				
18"(457mm)/24"(610mm)	54"(1372mm)	60"(1524mm)	WUCX-5460-	S	34	\$1449.44	\$1998.60	\$1528.84	\$2078.00	N/A	N/A	N/A	N/A		
		66"(1676mm)	WUCX-5466-	S	34	1668.56	2233.86	1748.84	2314.14	N/A	N/A	N/A	N/A		
		72"(1829mm)	WUCX-5472-	S	34	1780.67	2362.11	1861.83	2443.27	N/A	N/A	N/A	N/A		
24"(610mm)/18"(457mm)	54"(1372mm)	60"(1524mm)	WUCX-5460-	S	43	\$1449.44	\$1998.60	\$1528.84	\$2078.00	N/A	N/A	N/A	N/A		
		66"(1676mm)	WUCX-5466-	S	43	1668.56	2233.86	1748.84	2314.14	N/A	N/A	N/A	N/A		
		72"(1829mm)	WUCX-5472-	S	43	1780.67	2362.11	1861.83	2443.27	N/A	N/A	N/A	N/A		
24"(610mm)/30"(762mm)	54"(1372mm)	60"(1524mm)	WUCX-5460-	S	45	\$1494.06	\$2043.22	\$1577.04	\$2126.20	N/A	N/A	N/A	N/A		
		66"(1676mm)	WUCX-5466-	S	45	1713.18	2278.48	1797.04	2362.34	N/A	N/A	N/A	N/A		
		72"(1829mm)	WUCX-5472-	S	45	1825.29	2406.73	1910.03	2491.47	N/A	N/A	N/A	N/A		
30"(762mm)/24"(610mm)	54"(1372mm)	60"(1524mm)	WUCX-5460-	S	54	\$1494.06	\$2043.22	\$1577.04	\$2126.20	N/A	N/A	N/A	N/A		
		66"(1676mm)	WUCX-5466-	S	54	1713.18	2278.48	1797.04	2362.34	N/A	N/A	N/A	N/A		
		72"(1829mm)	WUCX-5472-	S	54	1825.29	2406.73	1910.03	2491.47	N/A	N/A	N/A	N/A		
18"(457mm)/24"(610mm)	60"(1524mm)	66"(1676mm)	WUCX-6066-	S	34	\$1713.38	\$2294.82	\$1794.54	\$2375.98	N/A	N/A	N/A	N/A		
		72"(1829mm)	WUCX-6072-	S	34	1825.49	2423.07	1907.53	2505.11	N/A	N/A	N/A	N/A		
24"(610mm)/18"(457mm)	60"(1524mm)	66"(1676mm)	WUCX-6066-	S	43	\$1713.38	\$2294.82	\$1794.54	\$2375.98	N/A	N/A	N/A	N/A		
		72"(1829mm)	WUCX-6072-	S	43	1825.49	2423.07	1907.53	2505.11	N/A	N/A	N/A	N/A		
24"(610mm)/30"(762mm)	60"(1524mm)	66"(1676mm)	WUCX-6066-	S	45	\$1758.00	\$2339.44	\$1842.74	\$2424.18	N/A	N/A	N/A	N/A		
		72"(1829mm)	WUCX-6072-	S	45	1870.11	2467.69	1955.73	2553.31	N/A	N/A	N/A	N/A		
30"(762mm)/24"(610mm)	60"(1524mm)	66"(1676mm)	WUCX-6066-	S	54	\$1758.00	\$2339.44	\$1842.74	\$2424.18	N/A	N/A	N/A	N/A		
		72"(1829mm)	WUCX-6072-	S	54	1870.11	2467.69	1955.73	2553.31	N/A	N/A	N/A	N/A		

Adaptable Worksurfaces

90° Merger

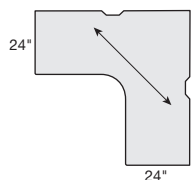
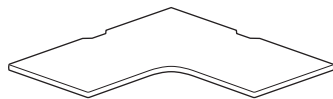

WUCQ-N44

Features

- Includes worksurface.
- Laminate with 3mm edgeband (J) or knife edge (F) on user edge and 1mm edgeband on sides and back.
- Wood veneer surface with 3mm edgeband (K) or knife (U) on user edge and 1mm edgeband on sides and back.
- Worksurfaces predrilled to accept most support options.
- Optional wireways along back edges are color-matched to solid side/back edge trim. When wood veneer or wood grain or patterned laminate is specified, wireways will be Charcoal. Refer to Specification Guide for wireway details.
- **Installed worksurfaces without wireway will not allow clearance for power plug.**
- Depths and widths shown in nominal dimensions.

Specification Tips

- 90° Merger is suggested alternative to using two perpendicular rectangular worksurfaces.
- **Corner bracket is required and must be separately specified.**
- **Worksurface support specific to product line and worksurface edge guidelines; must be separately specified; refer to Specification Guide for support and load.**
 - Cantilever brackets
 - Corner bracket - REQUIRED
 - Worksurface support panel
 - Side brackets
 - P-Leg
- Knife edge requires use of worksurface supports for that application; worksurface support panel and/or side bracket for use with knife edge.
- Mini cantilever brackets are for use with 18”(457mm) deep worksurfaces with knife edge only.
- **Not designed for use with an adjustable keyboard pad.**

To Order, Specify:

1) Product number, including:

1 Surface Options:

- L** Laminate
- W** Wood

2 Edge Options:

Laminate:

- J** Edgeband
- F** Knife

Wood:

- K** Edgeband
- U** Knife

3 Wireway Options:

- A** Notched
- C** Without

2) Laminate surface color or Wood finish color.

3) Edge trim color (laminate only).

Left/Right Depth	Width	Number	① ② ③			Laminate A		Laminate B		Wood Group A		Wood Group B		
			J	F	J	F	K	U	K	U				
18”(457mm)	36”(914mm)	WUCQ-3636-	■	■	S	N33	\$ 810.76	\$1141.53	\$ 859.50	\$1190.27	\$1255.58	\$1639.16	\$1294.48	\$1678.06
	42”(1067mm)	WUCQ-4242-	■	■	S	N33	886.87	1298.10	935.61	1346.84	1389.17	1715.27	1428.07	1754.17
	48”(1219mm)	WUCQ-4848-	■	■	S	N33	1054.23	1507.12	1102.97	1555.86	1598.82	2125.26	1637.72	2164.16
	54”(1372mm)	WUCQ-5454-	■	■	S	N33	1223.30	1729.55	1272.04	1778.29	N/A	N/A	N/A	N/A
24”(610mm)	36”(914mm)	WUCQ-3636-	■	■	S	N44	\$ 841.21	\$1171.98	\$ 889.95	\$1220.72	\$1286.03	\$1669.61	\$1324.93	\$1708.51
	42”(1067mm)	WUCQ-4242-	■	■	S	N44	917.32	1328.55	966.06	1377.29	1419.62	1745.72	1458.52	1784.62
	48”(1219mm)	WUCQ-4848-	■	■	S	N44	1084.68	1537.57	1133.42	1586.31	1629.27	2155.71	1668.17	2194.61
	54”(1372mm)	WUCQ-5454-	■	■	S	N44	1253.75	1760.00	1302.49	1808.74	N/A	N/A	N/A	N/A
30”(762mm)	36”(914mm)	WUCQ-3636-	■	■	S	N55	\$ 969.69	\$1300.46	\$1018.43	\$1349.20	\$1414.51	\$1798.09	\$1453.41	\$1836.99
	42”(1067mm)	WUCQ-4242-	■	■	S	N55	1045.80	1457.03	1094.54	1505.77	1548.10	1874.20	1587.00	1913.10
	48”(1219mm)	WUCQ-4848-	■	■	S	N55	1213.16	1666.05	1261.90	1714.79	N/A	N/A	N/A	N/A
	54”(1372mm)	WUCQ-5454-	■	■	S	N55	1382.23	1888.48	1430.97	1937.22	N/A	N/A	N/A	N/A

Adaptable Worksurfaces

Corner, 120° Wrap-Around

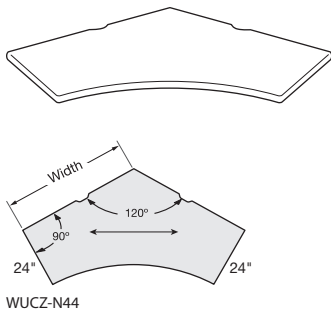

Features

- Includes worksurface and tie plate.
- Laminate with 3mm edgeband (J) or knife edge (F) on user edge and 1mm edgeband on sides and back.
- Wood veneer worksurface with 3mm edgeband (K) or knife (U) on user edge and 1mm edgeband on sides and back.
- Worksurfaces predrilled to accept most support options.
- Optional wireway along back edges of worksurface is color-matched to solid side/back edge trim. When wood veneer or wood grain or patterned laminate is specified, wireway will be Charcoal. Refer to Specification Guide for wireway details.
- **Installed worksurfaces without wireway will not allow clearance for power plug.**
- Depths and widths shown in nominal dimensions.

Specification Tips

- **Corner bracket is required and must be separately specified.**
- **Worksurface support specific to product line and worksurface edge guidelines; must be separately specified; refer to Specification Guide for support and load.**
 - Cantilever brackets
 - Corner bracket - REQUIRED
 - Worksurface support panel
 - Side brackets
 - P-leg
- Knife edge requires use of worksurface supports for that application; worksurface support panel and/or side bracket for use with knife edge.
- Mini cantilever brackets are for use with 18”(457mm) deep worksurfaces with knife edge only.
- Recommend the KU4A-0023-■ N or KU3A-0023-■ keyboard pad for 36”(914mm)-wide corners.

Note: Separately specified worksurface reinforcement channels provide additional support for worksurfaces with 50”(1270mm) spans that are heavily loaded and not otherwise supported by mid-span cantilevers, worksurface support panels, columns, legs or attached lower storage.

To Order, Specify:

1) Product number, including:

1 Surface Options:

- L** Laminate
- W** Wood

2 Edge Options:

Laminate:

- J** Edgeband

- F** Knife

Wood:

- K** Edgeband

- U** Knife

3 Wireway Options:

- A** Notched

- C** Without

2) Laminate surface color or Wood finish color.

3) Edge trim color (laminate only).

Left/Right Depth	Width	Number	1 2 3		Laminate A		Laminate B		Wood Group A		Wood Group B		
			J	F	J	F	K	U	K	U			
18”(457mm)	36”(914mm)	WUCZ-3636-	■	S	N33	\$1035.64	\$1441.99	\$1102.76	\$1509.11	\$1694.26	\$2198.72	\$1828.88	\$2333.34
	42”(1067mm)	WUCZ-4242-	■	S	N33	1177.18	1627.18	1254.41	1704.41	1910.71	2470.49	2083.88	2643.66
	48”(1219mm)	WUCZ-4848-	■	S	N33	1318.72	1812.37	1406.06	1899.71	2127.16	2742.26	2338.88	2953.98
	54”(1372mm)	WUCZ-5454-	■	S	N33	1460.26	1997.56	1557.71	2095.01	2343.61	3014.03	2593.88	3264.30
	60”(1524mm)	WUCZ-6060-	■	S	N33	1601.80	2182.75	1709.36	2290.31	N/A	N/A	N/A	N/A
24”(610mm)	36”(914mm)	WUCZ-3636-	■	S	N44	\$1169.11	\$1575.46	\$1246.86	\$1653.21	\$1828.54	\$2333.00	\$1987.10	\$2491.56
	42”(1067mm)	WUCZ-4242-	■	S	N44	1310.65	1760.65	1398.51	1848.51	2044.99	2604.77	2242.10	2801.88
	48”(1219mm)	WUCZ-4848-	■	S	N44	1452.19	1945.84	1550.16	2043.81	2261.44	2876.54	2497.10	3112.20
	54”(1372mm)	WUCZ-5454-	■	S	N44	1593.73	2131.03	1701.81	2239.11	2477.89	3148.31	2752.10	3422.52
	60”(1524mm)	WUCZ-6060-	■	S	N44	1735.27	2316.22	1853.46	2434.41	N/A	N/A	N/A	N/A
30”(762mm)	36”(914mm)	WUCZ-3636-	■	S	N55	\$1302.58	\$1708.93	\$1390.96	\$1797.31	\$1962.82	\$2467.28	\$2145.32	\$2649.78
	42”(1067mm)	WUCZ-4242-	■	S	N55	1444.12	1894.12	1542.61	1992.61	2179.27	2739.05	2400.32	2960.10
	48”(1219mm)	WUCZ-4848-	■	S	N55	1585.66	2079.31	1694.26	2187.91	2395.72	3010.82	2655.32	3270.42
	54”(1372mm)	WUCZ-5454-	■	S	N55	1727.20	2264.50	1845.91	2383.21	N/A	N/A	N/A	N/A
	60”(1524mm)	WUCZ-6060-	■	S	N55	1868.74	2449.69	1997.56	2578.51	N/A	N/A	N/A	N/A

Adaptable Worksurfaces

D-Shaped Convergent

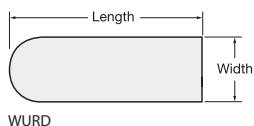
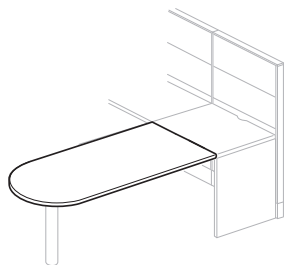
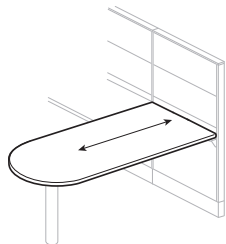

Features

- Includes work surface and tie plate.
- Laminate with 3mm edgeband (J) or knife edge (F) on user edge and 1mm edgeband on back (width).
- Wood veneer work surface with 3mm edgeband (K) or knife (U) on user edge and 1mm edgeband on back (width).
- Worksurfaces predrilled to accept most support options.
- Optional wireway is centered on back edge and is color-matched to solid side/back edge trim. When wood veneer or wood grain or patterned laminate is specified, wireway will be Charcoal. Refer to Specification Guide for wireway details.
- **Installed worksurfaces without wireway will not allow clearance for power plug.**
- **Must be attached to a panel or face of a straight work surface.**
- Depths and widths shown in nominal dimensions.

Specification Tips

- Work surface support must be separately specified. Select one of the following required floor support options:
 - Work surface support post or column
 - Attached lower storage
- **Work surface support specific to product line and work surface edge guidelines; must be separately specified; refer to Specification Guide for support and load.**
- Knife edge requires use of work surface supports for that application; work surface support panel and/or side bracket for use with knife edge.
- In addition to the required floor support, separately specify the appropriate support options. Select one or more of the following:
 - Cantilever bracket
 - Side bracket
 - Work surface support panel
 - Flush mount plates
 - P-Leg
- For aesthetic reasons, when using edgeband edge option, consider specifying D-Shaped Convergent Wrap-Around.

Note: Separately specified work surface reinforcement channels provide additional support for work surfaces with 50”(1270mm) spans that are heavily loaded and not otherwise supported by mid-span cantilevers, work surface support panels, columns, legs or attached lower storage.

To Order, Specify:

1) Product number, including:

1 Surface Options:

- L** Laminate
- W** Wood

2 Edge Options:

- Laminate:
- J** Edgeband
 - F** Knife
- Wood:
- K** Edgeband
 - U** Knife

3 Wireway Options:

- A** Notched
- C** Without

2) Laminate surface color or Wood finish color.

3) Edge trim color (laminate only).

Width	Length	Number				Laminate A		Laminate B		Wood Group A		Wood Group B	
			1	2	3	J	F	J	F	K	U	K	U
24”(610mm)	36”(914mm)	WURD-2436-	■	■	S	\$ 471.24	\$ 712.55	\$ 502.59	\$ 743.90	\$1248.72	\$1643.73	\$1303.13	\$1698.14
	42”(1067mm)	WURD-2442-	■	■	S	540.47	800.58	576.74	836.85	1434.30	1871.26	1498.55	1935.51
	48”(1219mm)	WURD-2448-	■	■	S	612.00	898.43	654.01	940.44	1619.88	2115.57	1695.61	2191.30
	54”(1372mm)	WURD-2454-	■	■	S	681.23	986.46	727.34	1032.57	1805.46	2343.10	1889.39	2427.03
	60”(1524mm)	WURD-2460-	■	■	S	752.76	1084.31	804.61	1136.16	1991.04	2587.41	2086.45	2682.82
	66”(1676mm)	WURD-2466-	■	■	S	823.14	1177.25	879.91	1234.02	2176.62	2823.33	2281.87	2928.58
30”(762mm)	36”(914mm)	WURD-3036-	■	■	S	\$ 636.18	\$ 929.62	\$ 667.53	\$ 960.97	\$1409.52	\$1853.52	\$1463.93	\$1907.93
	42”(1067mm)	WURD-3042-	■	■	S	702.35	1014.59	738.62	1050.86	1597.62	2083.57	1661.87	2147.82
	48”(1219mm)	WURD-3048-	■	■	S	770.82	1109.38	812.83	1151.39	1785.72	2330.40	1861.45	2406.13
	54”(1372mm)	WURD-3054-	■	■	S	836.99	1194.35	883.10	1240.46	1973.82	2560.45	2057.75	2644.38
	60”(1524mm)	WURD-3060-	■	■	S	905.46	1289.14	957.31	1340.99	2161.92	2807.28	2257.33	2902.69
	66”(1676mm)	WURD-3066-	■	■	S	972.78	1379.02	1029.55	1435.79	2350.02	3045.72	2455.27	3150.97
36”(914mm)	36”(914mm)	WURD-3636-	■	■	S	\$ 651.04	\$ 949.34	\$ 682.39	\$ 980.69	\$1473.03	\$1926.83	\$1527.44	\$1981.24
	42”(1067mm)	WURD-3642-	■	■	S	720.27	1037.37	756.54	1073.64	1663.65	2159.40	1727.90	2223.65
	48”(1219mm)	WURD-3648-	■	■	S	791.80	1135.22	833.81	1177.23	1854.27	2408.75	1930.00	2484.48
	54”(1372mm)	WURD-3654-	■	■	S	861.03	1223.25	907.14	1269.36	2044.89	2641.32	2128.82	2725.25
	60”(1524mm)	WURD-3660-	■	■	S	932.56	1321.10	984.41	1372.95	2235.51	2890.67	2330.92	2986.08
	66”(1676mm)	WURD-3666-	■	■	S	1002.94	1414.04	1059.71	1470.81	2426.13	3131.63	2531.38	3236.88
72”(1829mm)	WURD-3672-	■	■	S	1072.17	1502.07	1133.04	1562.94	2616.75	3364.20	2730.20	3477.65	

Adaptable Worksurfaces

Rectangular Convergent

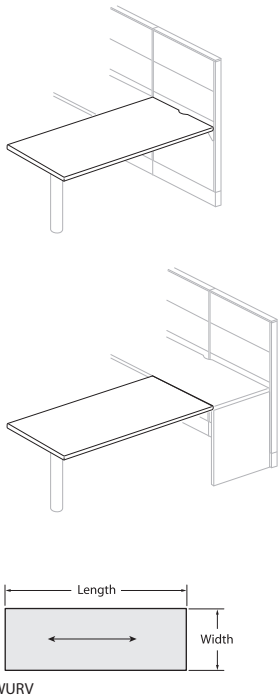

Features

- Includes worksurface and tie plate.
- Laminate with 3mm edgeband (J) or knife edge (F) on user edges and 1mm edgeband on front and back (width).
- Wood veneer worksurface 3mm edgeband (K) or knife (U) on user edges and 1mm edgeband on front and back (width).
- Worksurfaces predrilled to accept most support options.
- Optional wireway along back edge of worksurface is color-matched to solid side/back edge trim. When wood veneer or wood grain or patterned laminate is specified, wireway will be Charcoal. Refer to Specification Guide for wireway details.
- **Installed worksurfaces without wireway will not allow clearance for power plug.**
- Must be attached to a panel or face of a straight worksurface.
- Depths and widths shown in nominal dimensions.

Specification Tips

- Worksurface support must be separately specified. Select one of the following required floor support options:
 - Worksurface support post or column
 - Attached lower storage
- **Worksurface support specific to product line and worksurface edge guidelines; must be separately specified; refer to Specification Guide for support and load.**
- Knife edge requires use of worksurface supports for that application; worksurface support panel and/or side bracket for use with knife edge.
- In addition to the required floor support, separately specify the appropriate support options. Select one or more of the following:
 - Cantilever bracket
 - Worksurface support panel
 - Side bracket
 - Standard link cantilever bracket
 - Flush mount plates
 - P-Leg
- For aesthetic reasons, when using edgeband edge option, consider specifying D-Shaped Convergent Wrap-Around.

Note: Separately specified worksurface reinforcement channels provide additional support for worksurfaces with 50”(1270mm) spans that are heavily loaded and not otherwise supported by mid-span cantilevers, worksurface support panels, columns, legs or attached lower storage.

To Order, Specify:

1) Product number, including:

1 Surface Options:

- L** Laminate
- W** Wood

2 Edge Options:

Laminate:

- J** Edgeband
- F** Knife

Wood:

- K** Edgeband
- U** Knife

3 Wireway Options:

- A** Notched
- C** Without

2) Laminate surface color or Wood finish color.

3) Edge trim color (laminate only).

Width	Length	Number	Laminate A		Laminate B		Laminate E		Wood Group A		Wood Group B		
			1	2	J	F	J	F	J	F	K	U	
24”(610mm)	36”(914mm)	WURV-2436-	S	\$ 450.66	\$ 683.73	\$ 480.95	\$ 714.02	\$ 574.17	\$ 807.24	\$1198.74	\$1578.02	\$1251.31	\$1630.59
	42”(1067mm)	WURV-2442-	S	517.47	768.19	552.50	803.22	660.78	911.50	1298.10	1706.08	1357.33	1765.31
	48”(1219mm)	WURV-2448-	S	586.50	861.93	627.06	902.49	752.91	1028.34	1397.46	1845.62	1464.46	1912.62
	54”(1372mm)	WURV-2454-	S	653.31	946.39	697.82	990.90	836.22	1129.30	1496.82	1973.68	1569.37	2046.23
	60”(1524mm)	WURV-2460-	S	722.34	1040.13	772.38	1090.17	928.35	1246.14	1596.18	2113.22	1676.50	2193.54
	66”(1676mm)	WURV-2466-	S	790.26	1129.23	845.04	1184.01	1016.07	1355.04	1695.54	2247.02	1782.52	2334.00
	72”(1829mm)	WURV-2472-	S	857.07	1213.69	915.80	1272.42	1099.38	1456.00	1794.90	2375.08	1887.43	2467.61
30”(762mm)	36”(914mm)	WURV-3036-	S	\$ 594.13	\$ 877.53	\$ 624.42	\$ 907.82	\$ 717.64	\$1001.04	\$1316.66	\$1743.28	\$1369.23	\$1795.85
	42”(1067mm)	WURV-3042-	S	658.00	959.05	693.03	994.08	801.31	1102.36	1431.38	1886.70	1490.61	1945.93
	48”(1219mm)	WURV-3048-	S	724.09	1049.85	764.65	1090.41	890.50	1216.26	1546.10	2041.60	1613.10	2108.60
	54”(1372mm)	WURV-3054-	S	787.96	1131.37	832.47	1175.88	970.87	1314.28	1660.82	2185.02	1733.37	2257.57
	60”(1524mm)	WURV-3060-	S	854.05	1222.17	904.09	1272.21	1060.06	1428.18	1775.54	2339.92	1855.86	2420.24
	66”(1676mm)	WURV-3066-	S	919.03	1308.33	973.81	1363.11	1144.84	1534.14	1890.26	2489.08	1977.24	2576.06
	72”(1829mm)	WURV-3072-	S	982.90	1389.85	1041.63	1448.58	1225.21	1632.16	2004.98	2632.50	2097.51	2725.03
36”(914mm)	36”(914mm)	WURV-3636-	S	\$ 608.44	\$ 896.57	\$ 638.73	\$ 926.86	\$ 731.95	\$1020.08	\$1401.14	\$1837.22	\$1453.71	\$1889.79
	42”(1067mm)	WURV-3642-	S	675.25	981.03	710.28	1016.06	818.56	1124.34	1567.46	2032.24	1626.69	2091.47
	48”(1219mm)	WURV-3648-	S	744.28	1074.77	784.84	1115.33	910.69	1241.18	1733.78	2238.74	1800.78	2305.74
	54”(1372mm)	WURV-3654-	S	811.09	1159.23	855.60	1203.74	994.00	1342.14	1900.10	2433.76	1972.65	2506.31
	60”(1524mm)	WURV-3660-	S	880.12	1252.97	930.16	1303.01	1086.13	1458.98	2066.42	2640.26	2146.74	2720.58
	66”(1676mm)	WURV-3666-	S	948.04	1342.07	1002.82	1396.85	1173.85	1567.88	2232.74	2841.02	2319.72	2928.00
	72”(1829mm)	WURV-3672-	S	1014.85	1426.53	1073.58	1485.26	1257.16	1668.84	2399.06	3036.04	2491.59	3128.57

Adaptable Worksurfaces

D-Shaped Convergent, Wrap-Around

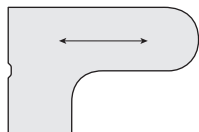
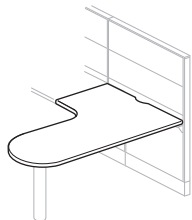

(Right-hand orientation)

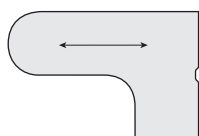

(Left-hand orientation)

WUCD-L

Features

- Includes worksurface and tie plate.
- Laminate with 3mm edgeband (J) or knife edge (F) on user edge and 1mm edgeband on side and back.
- Wood veneer worksurface 3mm edgeband (K) or knife (U) on user edge and 1mm edgeband on side and back (width).
- Worksurfaces predrilled to accept most support options.
- Optional wireway is centered on back edge and is color-matched to solid side/back edge trim. When wood veneer or wood grain or patterned laminate is specified, wireway will be Charcoal. Refer to Specification Guide for wireway details.
- **Installed worksurfaces without wireway will not allow clearance for power plug.**
- 36"(914mm)-wide surfaces have a 24"(610mm) diameter D-shaped radius.
- 42"(1067mm)- to 60"(1524mm)-wide surfaces have a 30"(762mm) diameter D-shaped radius.
- Depths and widths shown in nominal dimensions.

Specification Tips

- **Worksurface support specific to product line; must be separately specified.**
 - Worksurface support post or column
 - 21"(533mm) adjustable height disc base
 - Attached lower storage
- **Worksurface support specific to product line and worksurface edge guidelines; must be separately specified; refer to Specification Guide for support and load.**
- Knife edge requires use of worksurface supports for that application; worksurface support panel and/or side bracket for use with knife edge.
- Mini cantilever brackets are for use with 18"(457mm) deep worksurfaces with knife edge only.
- In addition to the required floor support, separately specify the appropriate support options. Select one or more of the following:
 - Cantilever bracket
 - Side bracket
 - Worksurface support panel
 - P-Leg
- Recommend the KU4A-0023-■ N or KU3A-0023-■ ■ keyboard pad for 36"(914mm)-wide corners.

Note: Separately specified worksurface reinforcement channels provide additional support for worksurfaces with 50"(1270mm) spans that are heavily loaded and not otherwise supported by mid-span cantilevers, worksurface support panels, columns, legs or attached lower storage.

To Order, Specify:

1) Product number, including:

① Surface Options:

L Laminate

W Wood

② Edge Options:

Laminate:

J Edgeband

F Knife

Wood:

K Edgeband

U Knife

③ Wireway Options:

A Notched

C Without

④ Orientation (as seated):

R Right-hand

L Left-hand

2) Laminate surface color or Wood finish color.

3) Edge trim color (laminated only).

Adaptable Worksurfaces

D-Shaped Convergent, Wrap-Around

Depth	Width	Length	Number	① ② ③ ④				Laminate A		Laminate B		Wood Group A		Wood Group B	
				J	F	J	F	K	U	K	U				
18"(457mm)	36"(914mm)	60"(1524mm)	WUCD-3660-	S	3	\$1387.88	\$1755.89	\$1487.81	\$1855.82	\$2328.86	\$2810.02	\$2499.28	\$2980.44		
		66"(1676mm)	WUCD-3666-	S	3	1432.82	1819.01	1535.99	1922.18	2412.56	2918.20	2597.68	3103.32		
		72"(1829mm)	WUCD-3672-	S	3	1562.72	1967.09	1669.13	2073.50	2581.22	3111.34	2781.04	3311.16		
24"(610mm)	36"(914mm)	60"(1524mm)	WUCD-3660-	S	4	\$1426.79	\$1788.67	\$1529.23	\$1891.11	\$2353.64	\$2833.45	\$2528.25	\$3008.06		
		66"(1676mm)	WUCD-3666-	S	4	1471.73	1851.79	1577.41	1957.47	2437.34	2941.63	2626.65	3130.94		
		72"(1829mm)	WUCD-3672-	S	4	1601.63	1999.87	1710.55	2108.79	2606.00	3134.77	2810.01	3338.78		
30"(762mm)	36"(914mm)	60"(1524mm)	WUCD-3660-	S	5	\$1465.70	\$1821.45	\$1570.65	\$1926.40	\$2378.42	\$2856.88	\$2557.22	\$3035.68		
		66"(1676mm)	WUCD-3666-	S	5	1510.64	1884.57	1618.83	1992.76	2462.12	2965.06	2655.62	3158.56		
		72"(1829mm)	WUCD-3672-	S	5	1640.54	2032.65	1751.97	2144.08	2630.78	3158.20	2838.98	3366.40		
18"(457mm)	42"(1067mm)	60"(1524mm)	WUCD-4260-	S	3	\$1471.73	\$1851.79	\$1577.41	\$1957.47	\$2437.34	\$2941.63	\$2626.65	\$3130.94		
		66"(1676mm)	WUCD-4266-	S	3	1516.67	1914.91	1625.59	2023.83	2521.04	3049.81	2725.05	3253.82		
		72"(1829mm)	WUCD-4272-	S	3	1561.61	1978.03	1673.77	2090.19	2604.74	3157.99	2823.45	3376.70		
24"(610mm)	42"(1067mm)	60"(1524mm)	WUCD-4260-	S	4	\$1510.64	\$1884.57	\$1618.83	\$1992.76	\$2462.12	\$2965.06	\$2655.62	\$3158.56		
		66"(1676mm)	WUCD-4266-	S	4	1555.58	1947.69	1667.01	2059.12	2545.82	3073.24	2754.02	3281.44		
		72"(1829mm)	WUCD-4272-	S	4	1600.52	2010.81	1715.19	2125.48	2629.52	3181.42	2852.42	3404.32		
30"(762mm)	42"(1067mm)	60"(1524mm)	WUCD-4260-	S	5	\$1549.55	\$1917.35	\$1660.25	\$2028.05	\$2486.90	\$2988.49	\$2684.59	\$3186.18		
		66"(1676mm)	WUCD-4266-	S	5	1594.49	1980.47	1708.43	2094.41	2570.60	3096.67	2782.99	3309.06		
		72"(1829mm)	WUCD-4272-	S	5	1639.43	2043.59	1756.61	2160.77	2654.30	3204.85	2881.39	3431.94		
18"(457mm)	48"(1219mm)	60"(1524mm)	WUCD-4860-	S	3	\$1516.67	\$1914.91	\$1625.59	\$2023.83	\$2521.04	\$3049.81	\$2725.05	\$3253.82		
		66"(1676mm)	WUCD-4866-	S	3	1561.61	1978.03	1673.77	2090.19	2604.74	3157.99	2823.45	3376.70		
		72"(1829mm)	WUCD-4872-	S	3	1606.55	2041.15	1721.95	2156.55	2688.44	3266.17	2921.85	3499.58		
24"(610mm)	48"(1219mm)	60"(1524mm)	WUCD-4860-	S	4	\$1555.58	\$1947.69	\$1667.01	\$2059.12	\$2545.82	\$3073.24	\$2754.02	\$3281.44		
		66"(1676mm)	WUCD-4866-	S	4	1600.52	2010.81	1715.19	2125.48	2629.52	3181.42	2852.42	3404.32		
		72"(1829mm)	WUCD-4872-	S	4	1645.46	2073.93	1763.37	2191.84	2713.22	3289.60	2950.82	3527.20		
30"(762mm)	48"(1219mm)	60"(1524mm)	WUCD-4860-	S	5	\$1594.49	\$1980.47	\$1708.43	\$2094.41	\$2570.60	\$3096.67	\$2782.99	\$3309.06		
		66"(1676mm)	WUCD-4866-	S	5	1639.43	2043.59	1756.61	2160.77	2654.30	3204.85	2881.39	3431.94		
		72"(1829mm)	WUCD-4872-	S	5	1684.37	2106.71	1804.79	2227.13	2738.00	3313.03	2979.79	3554.82		
18"(457mm)	54"(1372mm)	60"(1524mm)	WUCD-5460-	S	3	\$1561.61	\$1978.03	\$1673.77	\$2090.19	N/A	N/A	N/A	N/A		
		66"(1676mm)	WUCD-5466-	S	3	1606.55	2041.15	1721.95	2156.55	N/A	N/A	N/A	N/A		
		72"(1829mm)	WUCD-5472-	S	3	1651.49	2104.27	1770.13	2222.91	N/A	N/A	N/A	N/A		
24"(610mm)	54"(1372mm)	60"(1524mm)	WUCD-5460-	S	4	\$1600.52	\$2010.81	\$1715.19	\$2125.48	N/A	N/A	N/A	N/A		
		66"(1676mm)	WUCD-5466-	S	4	1645.46	2073.93	1763.37	2191.84	N/A	N/A	N/A	N/A		
		72"(1829mm)	WUCD-5472-	S	4	1690.40	2137.05	1811.55	2258.20	N/A	N/A	N/A	N/A		
30"(762mm)	54"(1372mm)	60"(1524mm)	WUCD-5460-	S	5	\$1639.43	\$2043.59	\$1756.61	\$2160.77	N/A	N/A	N/A	N/A		
		66"(1676mm)	WUCD-5466-	S	5	1684.37	2106.71	1804.79	2227.13	N/A	N/A	N/A	N/A		
		72"(1829mm)	WUCD-5472-	S	5	1729.31	2169.83	1852.97	2293.49	N/A	N/A	N/A	N/A		
18"(457mm)	60"(1524mm)	60"(1524mm)	WUCD-6060-	S	3	\$1606.55	\$2041.15	\$1721.95	\$2156.55	N/A	N/A	N/A	N/A		
		66"(1676mm)	WUCD-6066-	S	3	1651.49	2104.27	1770.13	2222.91	N/A	N/A	N/A	N/A		
		72"(1829mm)	WUCD-6072-	S	3	1696.43	2167.39	1818.31	2289.27	N/A	N/A	N/A	N/A		
24"(610mm)	60"(1524mm)	60"(1524mm)	WUCD-6060-	S	4	\$1645.46	\$2073.93	\$1763.37	\$2191.84	N/A	N/A	N/A	N/A		
		66"(1676mm)	WUCD-6066-	S	4	1690.40	2137.05	1811.55	2258.20	N/A	N/A	N/A	N/A		
		72"(1829mm)	WUCD-6072-	S	4	1735.34	2200.17	1859.73	2324.56	N/A	N/A	N/A	N/A		
30"(762mm)	60"(1524mm)	60"(1524mm)	WUCD-6060-	S	5	\$1684.37	\$2106.71	\$1804.79	\$2227.13	N/A	N/A	N/A	N/A		
		66"(1676mm)	WUCD-6066-	S	5	1729.31	2169.83	1852.97	2293.49	N/A	N/A	N/A	N/A		
		72"(1829mm)	WUCD-6072-	S	5	1774.25	2232.95	1901.15	2359.85	N/A	N/A	N/A	N/A		

Adaptable Worksurfaces

D-Shaped Ender

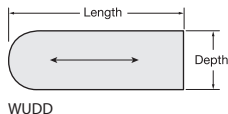
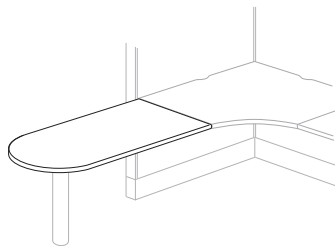

Features

- Includes work surface and tie plate.
- Laminate with 3mm edgeband (J) or knife edge (F) on user edge and 1mm edgeband on back (width).
- Wood veneer work surface with 3mm edgeband (K) or knife (U) on user edge and 1mm edgeband on back (width).
- Worksurfaces predrilled to accept most support options.
- **Must be attached to the depth of adjoining work surface.**
- Depths and widths shown in nominal dimensions.

Specification Tips

- **Work surface support specific to product line; must be separately specified.**
 - Work surface support post or column
 - 21" (533mm) adjustable height disc base
 - Attached lower storage
- **Work surface support specific to product line and work surface edge guidelines; must be separately specified; refer to Specification Guide for support and load.**
- In addition to the required floor support, separately specify the appropriate support options. Select one or more of the following:
 - Work surface support panel
 - Flush mount plate
 - Standard link cantilever bracket

Note: Separately specified work surface reinforcement channels provide additional support for work surfaces with 50" (1270mm) spans that are heavily loaded and not otherwise supported by mid-span cantilevers, work surface support panels, columns, legs or attached lower storage.

To Order, Specify:

1) Product number, including:

1 Surface Options:

- L** Laminate
- W** Wood

2 Edge Options:

- Laminate:
- J** Edgeband
 - F** Knife
- Wood:
- K** Edgeband
 - U** Knife

2) Laminate surface color or Wood finish color.

3) Edge trim color (laminate only).

Depth	Length	Number 1 2	Laminate A		Laminate B		Wood Group A		Wood Group B	
			J	F	J	F	K	U	K	U
18"(457mm)	36"(914mm)	WUDD-1836-SC	\$388.44	\$ 610.74	\$ 416.92	\$ 639.22	\$1145.08	\$1516.93	\$1200.31	\$1572.16
	42"(1067mm)	WUDD-1842-SC	444.60	687.00	477.76	720.16	1315.96	1737.97	1381.15	1803.16
	48"(1219mm)	WUDD-1848-SC	500.76	763.26	538.60	801.10	1486.84	1959.01	1561.99	2034.16
	54"(1372mm)	WUDD-1854-SC	556.92	839.52	599.44	882.04	1657.72	2180.05	1742.83	2265.16
	60"(1524mm)	WUDD-1860-SC	613.08	915.78	660.28	962.98	1828.60	2401.09	1923.67	2496.16
	66"(1676mm)	WUDD-1866-SC	669.24	992.04	721.12	1043.92	1999.48	2622.13	2104.51	2727.16
	72"(1829mm)	WUDD-1872-SC	725.40	1068.30	781.96	1124.86	2170.36	2843.17	2285.35	2958.16
24"(610mm)	36"(914mm)	WUDD-2436-SC	\$443.70	\$ 684.15	\$ 472.18	\$ 712.63	\$1203.69	\$1595.47	\$1258.92	\$1650.70
	42"(1067mm)	WUDD-2442-SC	514.92	775.47	548.08	808.63	1394.55	1836.49	1459.74	1901.68
	48"(1219mm)	WUDD-2448-SC	586.14	866.79	623.98	904.63	1585.41	2077.51	1660.56	2152.66
	54"(1372mm)	WUDD-2454-SC	657.36	958.11	699.88	1000.63	1776.27	2318.53	1861.38	2403.64
	60"(1524mm)	WUDD-2460-SC	728.58	1049.43	775.78	1096.63	1967.13	2559.55	2062.20	2654.62
	66"(1676mm)	WUDD-2466-SC	799.80	1140.75	851.68	1192.63	2157.99	2800.57	2263.02	2905.60
	72"(1829mm)	WUDD-2472-SC	871.02	1232.07	927.58	1288.63	2348.85	3041.59	2463.84	3156.58
30"(762mm)	36"(914mm)	WUDD-3036-SC	\$587.69	\$ 881.02	\$ 616.17	\$ 909.50	\$1359.38	\$1800.86	\$1414.61	\$1856.09
	42"(1067mm)	WUDD-3042-SC	655.91	969.34	689.07	1002.50	1550.24	2041.88	1615.43	2107.07
	48"(1219mm)	WUDD-3048-SC	724.13	1057.66	761.97	1095.50	1741.10	2282.90	1816.25	2358.05
	54"(1372mm)	WUDD-3054-SC	792.35	1145.98	834.87	1188.50	1931.96	2523.92	2017.07	2609.03
	60"(1524mm)	WUDD-3060-SC	860.57	1234.30	907.77	1281.50	2122.82	2764.94	2217.89	2860.01
	66"(1676mm)	WUDD-3066-SC	928.79	1322.62	980.67	1374.50	2313.68	3005.96	2418.71	3110.99
	72"(1829mm)	WUDD-3072-SC	997.01	1410.94	1053.57	1467.50	2504.54	3246.98	2619.53	3361.97

Adaptable Worksurfaces

Bent

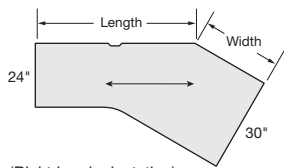

(Right-hand orientation)

WUCB-R45

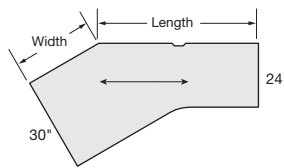

(Left-hand orientation)

WUCB-L54

Features

- Includes worksurface and tie plate.
- Laminate with 3mm edgeband (J) or knife edge (F) on user edge and 1mm edgeband on sides and back (width).
- Wood veneer worksurface with 3mm edgeband (K) or knife (U) on user edge and 1mm edgeband on sides and back (width).
- Worksurfaces predrilled to accept most support options.
- Optional wireway along back edge is color-matched to solid side/back edge trim. When wood veneer or wood grain or patterned laminate is specified, wireways will be Charcoal. Refer to Specification Guide for wireway details.
- **Installed worksurfaces without wireway will not allow clearance for power plug.**
- Depths and widths shown in nominal dimensions.

Specification Tips

- **Corner bracket is required and must be separately specified.**
- **Worksurface support specific to product line and worksurface edge guidelines; must be separately specified; refer to Specification Guide for support and load.**
 - Corner bracket - REQUIRED
 - Cantilever bracket
 - Support post, column, double support leg, or 21”(533mm) adjustable height disc base
- Knife edge requires use of worksurface supports for that application; worksurface support panel and/or side bracket for use with knife edge.

Note: Separately specified worksurface reinforcement channels provide additional support for worksurfaces with 50”(1270mm) spans that are heavily loaded and not otherwise supported by mid-span cantilevers, worksurface end panels, legs or attached storage.

To Order, Specify:

- 1) Product number, including:

1 Surface Options:

- L** Laminate
- W** Wood

2 Edge Options:

Laminate:

- J** Edgeband
- F** Knife

Wood:

- K** Edgeband
- U** Knife

3 Wireway Options:

- A** Notched
- C** Without

- 2) Laminate surface color or Wood finish color.
- 3) Edge trim color (laminate only).

Left/Right Depth	Width	Length	Number	①	②	③	Laminate A		Laminate B		Wood Group A		Wood Group B	
							J	F	J	F	K	U	K	U
24”(610mm)/30”(762mm)	24”(610mm)	36”(914mm)	WUCB-2436-	■	S	R45	\$1084.80	\$1536.91	\$1162.54	\$1614.65	\$1657.25	\$2192.66	\$1779.15	\$2314.56
		42”(1067mm)	WUCB-2442-	■	S	R45	1223.04	1720.03	1310.68	1807.67	1805.21	2391.19	1953.45	2539.43
		48”(1219mm)	WUCB-2448-	■	S	R45	1449.61	1991.48	1547.15	2089.02	2218.16	2854.71	2392.74	3029.29
		60”(1524mm)	WUCB-2460-	■	S	R45	1637.76	2269.39	1755.10	2386.73	2602.41	3340.10	2829.67	3567.36
24”(610mm)/30”(762mm)	30”(762mm)	36”(914mm)	WUCB-3036-	■	S	R45	\$1223.04	\$1720.03	\$1310.68	\$1807.67	\$1805.21	\$2391.19	\$1953.45	\$2539.43
		42”(1067mm)	WUCB-3042-	■	S	R45	1361.28	1903.15	1458.82	2000.69	1953.17	2589.72	2127.75	2764.30
		48”(1219mm)	WUCB-3048-	■	S	R45	1587.85	2174.60	1695.29	2282.04	2366.12	3053.24	2567.04	3254.16
		60”(1524mm)	WUCB-3060-	■	S	R45	1776.00	2452.51	1903.24	2579.75	2750.37	3538.63	3003.97	3792.23
30”(762mm)/24”(610mm)	24”(610mm)	36”(914mm)	WUCB-2436-	■	S	L54	\$1084.80	\$1536.91	\$1162.54	\$1614.65	\$1657.25	\$2192.66	\$1779.15	\$2314.56
		42”(1067mm)	WUCB-2442-	■	S	L54	1223.04	1720.03	1310.68	1807.67	1805.21	2391.19	1953.45	2539.43
		48”(1219mm)	WUCB-2448-	■	S	L54	1449.61	1991.48	1547.15	2089.02	2218.16	2854.71	2392.74	3029.29
		60”(1524mm)	WUCB-2460-	■	S	L54	1637.76	2269.39	1755.10	2386.73	2602.41	3340.10	2829.67	3567.36
30”(762mm)/24”(610mm)	30”(762mm)	36”(914mm)	WUCB-3036-	■	S	L54	\$1223.04	\$1720.03	\$1310.68	\$1807.67	\$1805.21	\$2391.19	\$1953.45	\$2539.43
		42”(1067mm)	WUCB-3042-	■	S	L54	1361.28	1903.15	1458.82	2000.69	1953.17	2589.72	2127.75	2764.30
		48”(1219mm)	WUCB-3048-	■	S	L54	1587.85	2174.60	1695.29	2282.04	2366.12	3053.24	2567.04	3254.16
		60”(1524mm)	WUCB-3060-	■	S	L54	1776.00	2452.51	1903.24	2579.75	2750.37	3538.63	3003.97	3792.23

Adaptable Worksurfaces

Countertop

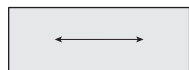
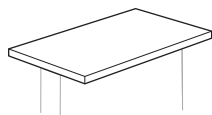

WUTS

Features

- Includes countertop and tie plate.
- Laminate with 3mm edgeband (J) or knife edge (F) on user edge and 1mm edgeband on ends.
- Wood veneer surface with 3mm edgeband (K) or knife (U) on user edges and 1mm edgeband on ends.
- Depths and widths shown in nominal dimensions.

Specification Tips

- **Requires separately specified mounting hardware.**
- For installation on panels 42"(1067mm)-high or higher.
- For use in applications that match panel width or multiple panel widths.
- **Countertop support specific to product line; must be separately specified.**

To Order, Specify:

1) Product number, including:

① Surface Options:

- L** Laminate
- W** Wood

② Edge Options:

Laminate:

- J** Edgeband
- F** Knife

Wood:

- K** Edgeband
- U** Knife

2) Laminate surface color or Wood finish color.

3) Edge trim color (laminates only).

Depth	Width	Number ①②	Laminate A		Laminate B		Wood Group A		Wood Group B	
			J	F	J	F	K	U	K	U
12"(305mm)	23"(584mm)	WUTS-1223-SC	\$498.28	\$ 742.10	\$534.83	\$ 778.65	\$ 872.05	\$1179.46	\$ 905.00	\$1212.41
	24"(610mm)	WUTS-1224-SC	502.64	747.99	539.50	784.85	879.24	1188.60	913.45	1222.81
	29"(737mm)	WUTS-1229-SC	524.44	777.44	562.85	815.85	915.19	1234.30	955.70	1274.81
	30"(762mm)	WUTS-1230-SC	528.80	783.33	567.52	822.05	922.38	1243.44	964.15	1285.21
	35"(889mm)	WUTS-1235-SC	550.60	812.78	590.87	853.05	958.33	1289.14	1006.40	1337.21
	36"(914mm)	WUTS-1236-SC	554.96	818.67	595.54	859.25	965.52	1298.28	1014.85	1347.61
	41"(1041mm)	WUTS-1241-SC	576.76	848.12	618.89	890.25	1001.47	1343.98	1057.10	1399.61
	42"(1067mm)	WUTS-1242-SC	581.12	854.01	623.56	896.45	1008.66	1353.12	1065.55	1410.01
	47"(1194mm)	WUTS-1247-SC	602.92	883.46	646.91	927.45	1044.61	1398.82	1107.80	1462.01
	48"(1219mm)	WUTS-1248-SC	607.28	889.35	651.58	933.65	1051.80	1407.96	1116.25	1472.41
	53"(1346mm)	WUTS-1253-SC	629.08	918.80	674.93	964.65	1087.75	1453.66	1158.50	1524.41
	54"(1372mm)	WUTS-1254-SC	633.44	924.69	679.60	970.85	1094.94	1462.80	1166.95	1534.81
	59"(1499mm)	WUTS-1259-SC	655.24	954.14	702.95	1001.85	1130.89	1508.50	1209.20	1586.81
	60"(1524mm)	WUTS-1260-SC	659.60	960.03	707.62	1008.05	1138.08	1517.64	1217.65	1597.21
	65"(1651mm)	WUTS-1265-SC	681.40	989.48	730.97	1039.05	1174.03	1563.34	1259.90	1649.21
	66"(1676mm)	WUTS-1266-SC	685.76	995.37	735.64	1045.25	1181.22	1572.48	1268.35	1659.61
	71"(1803mm)	WUTS-1271-SC	707.56	1024.82	758.99	1076.25	1217.17	1618.18	1310.60	1711.61
	72"(1829mm)	WUTS-1272-SC	711.92	1030.71	763.66	1082.45	1224.36	1627.32	1319.05	1722.01
	77"(1956mm)	WUTS-1277-SC	733.72	1060.16	787.01	1113.45	1260.31	1673.02	1361.30	1774.01
	78"(1981mm)	WUTS-1278-SC	738.08	1066.05	791.68	1119.65	1267.50	1682.16	1369.75	1784.41
	83"(2108mm)	WUTS-1283-SC	759.88	1095.50	815.03	1150.65	1303.45	1727.86	1412.00	1836.41
	84"(2134mm)	WUTS-1284-SC	764.24	1101.39	819.70	1156.85	1310.64	1737.00	1420.45	1846.81
	89"(2261mm)	WUTS-1289-SC	786.04	1130.84	843.05	1187.85	1346.59	1782.70	1462.70	1898.81
	90"(2286mm)	WUTS-1290-SC	790.40	1136.73	847.72	1194.05	1353.78	1791.84	1471.15	1909.21
	95"(2413mm)	WUTS-1295-SC	812.20	1166.18	871.07	1225.05	1389.73	1837.54	1513.40	1961.21
	96"(2438mm)	WUTS-1296-SC	816.56	1172.07	875.74	1231.25	1396.92	1846.68	1521.85	1971.61
	101"(2565mm)	WUTS-12A1-SC	838.36	1201.52	899.09	1262.25	1432.87	1892.38	1564.10	2023.61
	102"(2591mm)	WUTS-12A2-SC	842.72	1207.41	903.76	1268.45	1440.06	1901.52	1572.55	2034.01
	107"(2718mm)	WUTS-12A7-SC	864.52	1236.86	927.11	1299.45	1476.01	1947.22	1614.80	2086.01
	108"(2743mm)	WUTS-12A8-SC	868.88	1242.75	931.78	1305.65	1483.20	1956.36	1623.25	2096.41
	113"(2870mm)	WUTS-12B3-SC	890.68	1272.20	955.13	1336.65	1519.15	2002.06	1665.50	2148.41
	114"(2896mm)	WUTS-12B4-SC	895.04	1278.09	959.80	1342.85	1526.34	2011.20	1673.95	2158.81
	119"(3023mm)	WUTS-12B9-SC	916.84	1307.54	983.15	1373.85	1562.29	2056.90	1716.20	2210.81
	120"(3048mm)	WUTS-12C0-SC	921.20	1313.43	987.82	1380.05	1569.48	2066.04	1724.65	2221.21

Adaptable Worksurfaces

Conference End

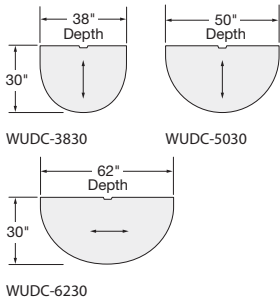
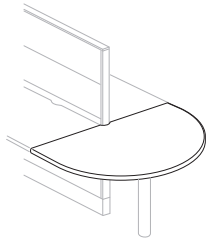

Features

- Includes work surface and tie plate.
- Laminate with 3mm edgeband (J) or knife edge (F) on user edge and 1mm edgeband on back.
- Wood veneer work surface with 3mm edgeband (K) or knife (U) on user edge and 1mm edgeband on back.
- Worksurfaces predrilled to accept most support options.
- Wireway required to accommodate end-of-run trim.
- Wireway is color-matched to solid side/back edge trim. When wood veneer or wood grain or patterned laminate is specified, wireway will be Charcoal. Refer to Specification Guide for wireway details.
- Depths and widths shown in nominal dimensions.

Specification Tips

- **Work surface support specific to product line and work surface edge guidelines; must be separately specified; refer to Specification Guide for support and load.**
- Knife edge requires use of work surface supports for that application; work surface support panel and/or side bracket for use with knife edge.
- Conference ends with single support posts or columns are generally not considered to be panel supports. See load guidelines in Specification Guide to insure that the panels are properly supported.
- The back edge of the conference end must be supported by either
 - Two FMK brackets (50”(1270mm)/62”(1575mm) depths)
 - A standard link cantilever (pair)
 - Work surface support panel
 - A combination of the previous three
- The front of the conference end must be supported by one of the following:
 - Support post, column, or 21”(533mm) adjustable height disc base - REQUIRED

Note: Grain direction will run across 62”(1575mm)-wide conference end work surface.

To Order, Specify:

1) Product number, including:

1 Surface Options:

- L** Laminate
- W** Wood

2 Edge Options:

Laminate:

- J** Edgeband

- F** Knife

Wood:

- K** Edgeband

- U** Knife

2) Laminate surface color or Wood finish color.

3) Edge trim color (laminated only).

Depth	Width	Number 1 2	Laminate A		Laminate B		Wood Group A		Wood Group B	
			J	F	J	F	K	U	K	U
38”(965mm)	30”(762mm)	WUDC-3830- SA	\$ 914.67	\$1301.75	\$ 977.24	\$1364.32	\$2700.03	\$3446.74	\$2830.23	\$3576.94
50”(1270mm)		WUDC-5030- SA	961.35	1364.63	1028.00	1431.28	2841.99	3627.94	2998.71	3784.66
62”(1575mm)		WUDC-6230- SA	1008.03	1427.51	1078.76	1498.24	2983.95	3809.14	3167.19	3992.38

Adaptable Worksurfaces

Key Conference End

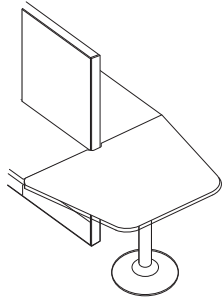

Features

- Includes worksurface and tie plate.
- Laminate with 3mm edgeband (J) or knife edge (F) on user edge and 1mm edgeband on back.
- Wood veneer worksurface with 3mm edgeband (K) or knife (U) on user edge and 1mm edgeband on back.
- Worksurfaces predrilled to accept most support options.
- Wireway along back edge is color-matched to solid side/back edge trim. When wood veneer or wood grain or patterned laminate is specified, wireway will be Charcoal. Refer to Specification Guide for wireway details.
- Depths and widths shown in nominal dimensions.
- Wireway required to accommodate end-of-run trim.

Specification Tips

- **Worksurface support specific to product line and worksurface edge guidelines; must be separately specified; refer to Specification Guide for support and load.**
- Knife edge requires use of worksurface supports for that application; worksurface support panel and/or side bracket for use with knife edge.
 - Mini cantilever brackets are for use with 18”(457mm) deep worksurfaces with knife edge only.
- Key ends with single support posts or columns are generally not considered to be panel supports. See load guidelines in Specification Guide to insure that the panels are properly supported.
- The back edge of the key end must be supported by either
 - Two FMK brackets (50”(1270mm)/62”(1575mm) depths)
 - A standard link bracket (pair)
 - Another component with shared worksurface support (Worksurface support panel, P-leg)
 - A combination of the previous three
- The front of the key end must be supported by one of the following:
 - Support post, column, or 21”(533mm) adjustable height disc base - REQUIRED
- To be used in conference end application.

Note: Grain direction for laminate Key End over 62”(1575mm)-deep will be reversed.

To Order, Specify:

1) Product number, including:

1 Surface Options:

- L** Laminate
- W** Wood

2 Edge Options:

Laminate:

- J** Edgeband
- F** Knife

Wood:

- K** Edgeband
- U** Knife

2) Laminate surface color or Wood finish color.

3) Edge trim color (laminate only).

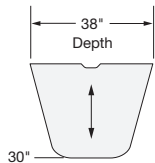

WURY-3830

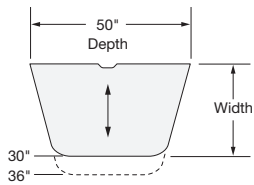

WURY-5030
WURY-5036

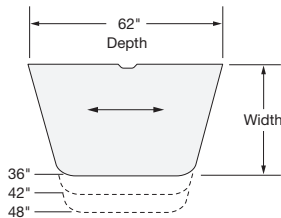

WURY-6236
WURY-6242
WURY-6248

Depth	Width	Number 1 2	Laminate A		Laminate B		Wood Group A		Wood Group B	
			J	F	J	F	K	U	K	U
38”(965mm)	30”(762mm)	WURY-3830- SA	\$1208.49	\$1698.92	\$1295.06	\$1785.49	\$3275.63	\$4258.86	\$3507.08	\$4490.31
50”(1270mm)	30”(762mm)	WURY-5030- SA	\$1215.09	\$1707.83	\$1302.11	\$1794.85	\$3281.66	\$4264.89	\$3514.15	\$4497.38
	36”(914mm)	WURY-5036- SA	1241.19	1740.90	1330.17	1829.88	3358.68	4364.34	3604.98	4610.64
62”(1575mm)	36”(914mm)	WURY-6236- SA	\$1247.79	\$1749.81	\$1337.22	\$1839.24	\$3364.71	\$4370.37	\$3612.05	\$4617.71
	42”(1067mm)	WURY-6242- SA	1273.89	1782.88	1365.28	1874.27	3441.73	4469.82	3702.88	4730.97
	48”(1219mm)	WURY-6248- SA	1299.99	1815.95	1393.34	1909.30	3518.75	4569.27	3793.71	4844.23

Adaptable Worksurfaces

120° Link

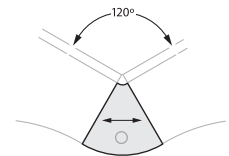
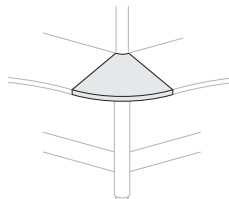

WUDZ

Features

- Includes worksurface and tie plate.
- Laminate with 3mm edgeband (J) or knife edge (F) on user edge and 1mm edgeband on sides and back.
- Wood veneer worksurface with 3mm edgeband (K) or knife (U) on user edge and 1mm edgeband on back.
- Worksurfaces predrilled to accept most support options.
- Depths and widths shown in nominal dimensions.

Specification Tips

- Support column, leg or worksurface support panel may be used dependent upon application.
- Use with Corner, 120° Wrap-Around worksurfaces.
- **Worksurface support specific to product line and worksurface edge guidelines; must be separately specified; refer to Specification Guide for support and load.**
 - P-Leg
 - Support post
 - Support column
 - Worksurface support panel
 - Tie plate with 18”(457mm) depth
 - Flush mount plates with 24”(610mm) and 30”(762mm) depths
 - Standard link cantilevers
- Knife edge requires use of worksurface supports for that application; worksurface support panel and/or side bracket for use with knife edge.
- Mini cantilever brackets are for use with 18”(457mm) deep worksurfaces with knife edge only.

To Order, Specify:

1) Product number, including:

① Surface Options:

- L** Laminate
- W** Wood

② Edge Options:

Laminate:

- J** Edgeband
- F** Knife

Wood:

- K** Edgeband
- U** Knife

2) Laminate surface color or Wood finish color.

3) Edge trim color (laminated only).

Depth	Number ① ②	Laminate A		Laminate B		Wood Group A		Wood Group B	
		J	F	J	F	K	U	K	U
18”(457mm)	WUDZ-1820- ■ ■ SC	\$462.92	\$ 712.65	\$496.50	\$ 746.23	\$1243.83	\$1670.75	\$1348.09	\$1775.01
24”(610mm)	WUDZ-2426- ■ ■ SC	507.76	757.49	541.34	791.07	1382.35	1809.27	1451.22	1878.14
30”(762mm)	WUDZ-3032- ■ ■ SC	717.36	1047.51	770.37	1100.52	1929.36	2539.96	2058.34	2668.94

Worksurface Supports

for use with UniGroup Too, UniGroup & PLACES

	Height	Depth	Width	Description	Number ¹	Price P	Price A C	Price B C
Standard Cantilever Bracket	9"(229mm)	16.5"(419mm)	1.625"(41mm)	Pair	ZEBD-1600- P	\$163.14	\$240.24	\$251.67
				Left-hand	ZEBD-1600- L	99.33	127.37	131.19
				Right-hand	ZEBD-1600- R	99.33	127.37	131.19

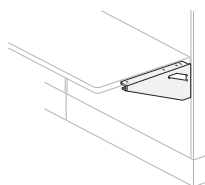

ZEBD-1600
(Right-hand shown)

Features

- Includes one right- and/or one left-handed bracket and mounting screws.
- Provides cantilever support for the left and/or right side of worksurface.
- Installs in panel side trim rail.
- Cantilever bracket can be used on either a 18"(457mm)-, 24"(610mm)- or 30"(762mm)-deep worksurface.
- Mounts worksurface in one inch vertical increments from a minimum of 15"(381mm) high.
- Provides clear access leg swing when supporting 24"(610mm)- and 30"(762mm)-deep worksurfaces at standard 29"(737mm) height.
- (P) finish option standard in black.

To Order, Specify:

- 1) Product number.

1 Color Option:

- P** Standard
- C** Trim color (A, B).

- 2) Trim color if applicable.

Standard Mini Cantilever Bracket	9"(229mm)	10.5"(267mm)	1.625"(41mm)	Pair	ZEBD-1000- P	\$184.08	\$261.18	\$272.61
				Left-hand	ZEBD-1000- L	111.31	139.35	143.17
				Right-hand	ZEBD-1000- R	111.31	139.35	143.17

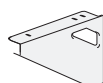

ZEBD-1000
(Right-hand shown)

Features

- Includes one right- and/or one left-handed bracket and mounting screws.
- Provides cantilever support for the left or right side of worksurface.
- Installs in panel side trim rail.
- Cantilever bracket to be used on 18"(457mm)- deep rectangular radius end worksurface with edgeband.
- Mounts worksurface in one inch vertical increments from a minimum of 15"(381mm) high.
- (P) finish option standard in black.

To Order, Specify:

- 1) Product number.

1 Color Option:

- P** Standard
- C** Trim color (A, B).

- 2) Trim color if applicable.

Standard Link Cantilever Bracket	9"(229mm)	16.5"(419mm)	3.75"(95mm)	Pair	ZEBL-1600- P	\$191.18	\$268.28	\$279.71
				Left-hand	ZEBL-1600- L	115.34	143.38	147.20
				Right-hand	ZEBL-1600- R	115.34	143.38	147.20

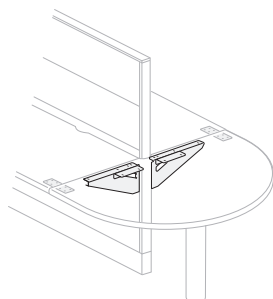

ZEBL-1600

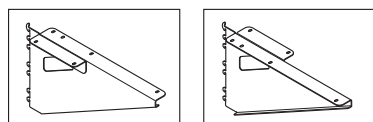

Left

Right

Features

- Includes one right- and/or one left-handed bracket, with attached angle bracket and mounting screws.
- Provides cantilever support for the left or right side of conference end, key conference end and 120° link and the adjoining worksurface.
- Installs in panel side trim rail.
- Cantilever bracket can be used on either a 18"(457mm)-, 24"(610mm)- or 30"(762mm)-deep worksurface.
- Mounts worksurface in one inch vertical increments from a minimum of 15"(381mm) high.
- Provides clear access leg swing when supporting 24"(610mm)- and 30"(762mm)-deep worksurfaces at standard 29"(737mm) height.
- (P) finish option standard in black.

To Order, Specify:

- 1) Product number.

1 Color Option:

- P** Standard
- C** Trim color (A, B).

- 2) Trim color if applicable.

Specification Tip

- To be used with conference end, key conference end, D-shape ender and 120° link only.

Worksurface Supports

for use with UniGroup Too, UniGroup & PLACES

	Height	Depth	Description	Number	Price
Standard Snap-n-Fit Cantilever Bracket for Rectangular Worksurfaces	10.5"(267mm)	19"(483mm)	Pair	ZEBS-1900-PP	\$470.04
			Left-hand	ZEBS-1900-PL	258.69
			Right-hand	ZEBS-1900-PR	258.69

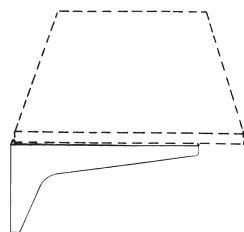

ZEBS-1900

Features

- Includes one right- and/or one left-handed bracket, U-channel and mounting screws.
- Provides cantilever support for the left and/or right side of work surface.
- Installs in panel side trim rail.
- Mounts work surface in one inch vertical increments from a minimum of 15"(381mm) high.
- Provides clear access leg swing when supporting 24"(610mm)- and 30"(762mm)-deep work surfaces at standard 29"(737mm) height.

To Order, Specify:

- 1) Product number.
- 2) Non-metallic trim color.

Specification Tips

- Worksurfaces are predrilled for snap-n-fit cantilevers.
- Cantilever bracket can be used on either a 24"(610mm)- or 30"(762mm)-deep work surface.
- Cannot be used on 18"(457mm)-deep work surfaces.

Standard Snap-n-Fit Mini Cantilever Bracket for Rectangular Worksurfaces	10.5"(267mm)	12"(305mm)	Pair	ZEBS-1200-PP	\$357.48
			Left-hand	ZEBS-1200-PL	194.35
			Right-hand	ZEBS-1200-PR	194.35

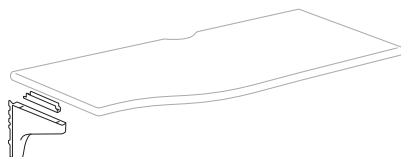

ZEBS-1200

Features

- Includes one right- and/or one left-handed bracket, U-channel and mounting screws.
- Provides cantilever support for the left or right side of work surface.
- Installs in panel side trim rail.
- Mounts work surface in one inch vertical increments from a minimum of 15"(381mm) high.

To Order, Specify:

- 1) Product number.
- 2) Non-metallic trim color.

Specification Tips

- Worksurfaces are predrilled for snap-n-fit cantilevers.
- Cantilever bracket can be used on 18"(457mm)-deep rectangular work surfaces, 18"(457mm) to 24"(610mm)-deep rectangular radius end, 24"(610mm) to 30"(762mm)-deep corner 90° split top and rectangular split top work surfaces.

Worksurface Supports

for use with UniGroup Too, UniGroup & PLACES

	Height	Depth	Description	Number	Price
Standard Snap-n-Fit Cantilever Bracket for Corner Worksurface	10.5"(267mm)	19"(483mm)	Pair	ZEBC-1900-PP	\$479.68

Standard Snap-n-Fit Cantilever Bracket for Corner Worksurface



ZEBC-1900

Feature

- Includes one right and one left-hand cantilever, two U-channels (1 corner, 1 rectangular) and mounting screws.

Specification Tips

- Worksurfaces are predrilled for snap-n-fit cantilevers.
- To be used with 24"(610mm)-deep or 30"(762mm)-deep 90° and 120° corner and extended worksurfaces.**
- Exception: Not to be used with 24"(610mm)-deep, 90° split top corner worksurface or 24"(610mm)-deep rectangular split top worksurface.**

To Order, Specify:

- Product number.
- Non-metallic trim color.

Standard Snap-n-Fit Mini Cantilever Bracket for Corner Worksurface	10.5"(267mm)	12"(267mm)	Pair	ZEBC-1200-PP	\$403.97
---	--------------	------------	------	--------------	----------

Standard Snap-n-Fit Mini Cantilever Bracket for Corner Worksurface

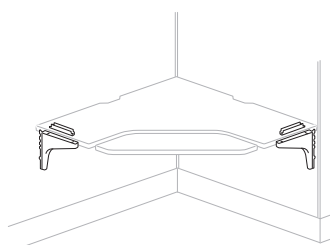

ZEBC-1200

Feature

- Includes one right and one left-hand cantilever, two U-channels (1 corner, 1 rectangular) and mounting screws.

Specification Tips

- Worksurfaces are predrilled for snap-n-fit cantilevers.
- To be used with 18"(457mm)-deep 90° and 120° corner and extended worksurfaces.**
- To be used with 24"(610mm)-deep 90° split top corner worksurfaces.**

To Order, Specify:

- Product number.
- Non-metallic trim color.

Anti Dislodgement Bracket for use with Worksurface Support Panels

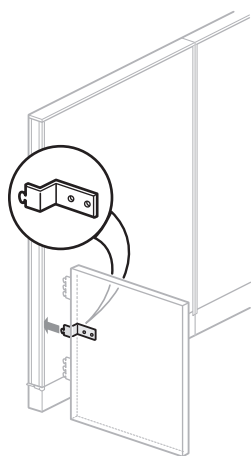

ZEBF-0000-P

	Number ^①	Price
	ZEBF-0000-P	\$150.92

Features

- Includes one left or right-hand shared or non-shared anti-dislodgement bracket and mounting screws.
- Standard in black finish only.

Specification Tips

- Anti-Dislodgement Bracket only for use with worksurface support panels used in conjunction with a worksurface.**
- Worksurface support panel with anti-dislodgement bracket can be used in place of a return panel in some applications.
- See Load and Support guidelines for details.

To Order, Specify:

- Product number, including: (No finish specification required.)

① Handedness:

- R Right
- L Left

Worksurface Supports

for use with UniGroup Too, UniGroup & PLACES

	Height	Depth	Width	Description	Number	Price
Side Bracket	2"(51mm)	1.5"(38mm)	2.625"(67mm)	Left	ZEBA-0000-PL	\$30.94
				Right	ZEBA-0000-PR	30.94

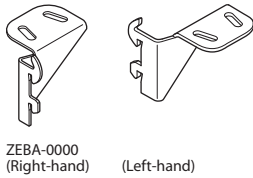

Features

- Includes one left- or right-hand bracket and mounting screws.
- Mounts ends of rectilinear worksurface to adjacent panel.
- Worksurface depth and return panel width must be equal.
- Standard in Charcoal finish only.

To Order, Specify:

- 1) Product number. (No finish specification required.)

Specification Tip

- Not recommended for use with convergent worksurface.

Convergent Mount Bracket	4.75"(121mm)	1.875"(48mm)	4.25"(108mm)	Left	ZEBV-0000-PL	\$37.31
				Right	ZEBV-0000-PR	37.31

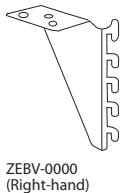

Features

- Includes one left- or right-hand bracket, mounting screws and anti-dislodgement clip.
- Mounts one corner of straight end of convergent worksurface to panel side rails.
- Standard in Charcoal finish only.

To Order, Specify:

- 1) Product number. (No finish specification required.)

Flush Mount Plate		3"(76mm)	4"(102mm)		ZUBF-0000-PN	\$35.85
--------------------------	--	----------	-----------	--	--------------	----------------

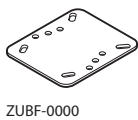

Features

- Includes one bracket and mounting screws.
- Mounts straight end of convergent worksurfaces or conference end worksurfaces to panel-hung worksurfaces.
- Provides 90° attachment of two worksurfaces at the same height.
- Standard in Charcoal finish only.

To Order, Specify:

- 1) Product number. (No finish specification required.)

Rear-Corner Bracket	2"(51mm)	1.5"(38mm)	2.625"(67mm)		ZEBR-0000-PN	\$28.43
----------------------------	----------	------------	--------------	--	--------------	----------------

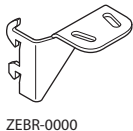

Features

- Includes one left-hand bracket and mounting screws.
- Attaches rear corner of worksurface to left hand side trim rail of panel.
- Standard in Charcoal finish only.

To Order, Specify:

- 1) Product number. (No finish specification required.)

Specification Tip

- **Required for all corner worksurfaces.**

Counter Top Brackets

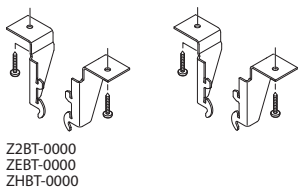

Description	Height	Number	Price	
			A	B
UniGroup Too for Square Painted Top Cap	2.59"(66mm)	Z2BT-0000-PNE	\$162.88	\$164.52
UniGroup for Radius Steel Top Cap	2.76"(70mm)	ZEBT-0000-PNE	162.88	N/A
PLACES for Low Profile Steel/Wood Top Cap	2.59"(66mm)	ZHBT-0000-PNE	162.88	N/A

Feature

- Includes countertop brackets and screws to support countertops up to 60"(1524mm) wide. For wider widths order additional brackets as needed so that brackets are positioned a maximum of 60"(1524mm) apart.

To Order, Specify:

- 1) Product number.
- 2) Trim color.

Specification Tips

- For UniGroup radius wood top cap, specify UniGroup for radius steel top cap and add field supplied spacers to accommodate height difference.
- UniGroup Too for square painted top cap brackets are available in Metallic finish.

Adaptable Worksurface Supports

for use with UniGroup Too, UniGroup & PLACES

	Height	Depth	Description	Number	Price	
					A	B
Pedestal-to-Panel Bracket	2"(51mm)	27.25"(692mm)	Left-hand	ZEBN-0000-PLJ	\$266.35	\$287.23
			Right-hand	ZEBN-0000-PRJ	266.35	287.23

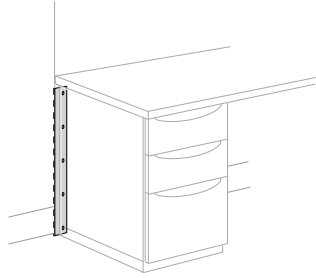

ZEBN-0000

Features

- Includes one handed bracket and mounting screws.
- Installs in side trim rail slots and attaches to the back side of an attached pedestal.
- Bracket is predrilled for attachment to pedestal.

Specification Tips

- Worksurface and pedestal have to be same depth (nominal).
- Not for use with lateral files.
- For use with edgeband worksurfaces.

To Order, Specify:

- 1) Product number.
- 2) Trim color.

Adaptable Worksurface Supports

Worksurface Support Panels

Laminate Height	Thickness	Depth	Number ①	Laminate A	Laminate B
27.875"(708mm)	1.5"(38mm)	12"(305mm)	ZEFS-1200-LNE	\$445.62	\$482.93
		18"(457mm)	ZEFS-1800-LNE	482.94	517.49
		24"(610mm)	ZEFS-2400-LNE	520.26	552.05
		30"(762mm)	ZEFS-3000-LNE	557.58	586.61

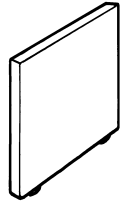

ZEFS

Edgeband



Knife

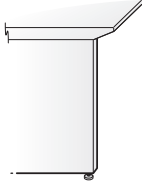

Features

- Includes support panel with glides and mounting hardware.
- Installs in panel frame component slots and attaches under the end of a worksurface.
- Provides full support for one end of equal depth worksurfaces.
- Recommended in heavy loading conditions.
- Non-handed design may be installed in left-hand, right-hand or shared configuration.
- Laminate or wood surfaces with plastic edge trim, 3mm radiused user edge provides soft access to knee space.
- Adjustable glides provide a maximum of 2.5"(64mm) of height adjustment.

Specification Tips

- Specify worksurface support panel to match worksurface edge option.
- Separately specify Anti-Dislodgement Bracket for additional support. Please refer to Anti-Dislodgement Bracket price list page for specification tips.

To Order, Specify:

- 1) Product number, including:

① Edge Options:

J Edgeband

F Knife

- 2) Laminate color.

- 3) Edge trim color.

Wood Height	Thickness	Depth	Number ①	Wood Group A	Group B
27.875"(708mm)	1.5"(38mm)	12"(305mm)	ZEFS-1200-WNE	\$791.83	\$ 868.17
		18"(457mm)	ZEFS-1800-WNE	839.77	922.59
		24"(610mm)	ZEFS-2400-WNE	887.71	977.01
		30"(762mm)	ZEFS-3000-WNE	935.65	1031.43

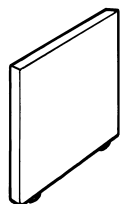

ZEFS

Edgeband



Knife

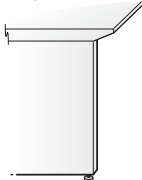

Features

- Includes support panel with glides and mounting hardware.
- Installs in panel frame component slots and attaches under the end of a worksurface.
- Provides full support for one end of equal depth worksurfaces.
- Recommended in heavy loading conditions.
- Non-handed design may be installed in left-hand, right-hand or shared configuration.
- Laminate or wood surfaces with plastic edge trim, 3mm radiused user edge provides soft access to knee space.
- Adjustable glides provide a maximum of 2.5"(64mm) of height adjustment.

Specification Tips

- Specify worksurface support panel to match worksurface edge option.
- Separately specify Anti-Dislodgement Bracket for additional support. Please refer to Anti-Dislodgement Bracket price list page for specification tips.

To Order, Specify:

- 1) Product number, including:

① Edge Options:

K Edgeband

U Knife Edge

- 2) Wood finish color.

Worksurface Supports

	Number	Price
Straight Leg Basic	WUCL-0001	\$193.52



WUCL-0001
Class CA

Features

- Includes one leg and mounting screws.
- 4"(102mm) glide adjustment range allows worksurface heights from 27"(686mm) to 31"(787mm).
- 2.25"(57mm) diameter column includes 6"(152mm)-diameter top plate.
- Standard in Charcoal finish only.
- Shipped assembled.

To Order, Specify:

- 1) Product number.
(No finish specification required.)

Specification Tip

- Predrilled for convergent worksurfaces and end-of-run worksurface application.

Support Column	Number	Price	
		A	B
	WUCC-0004	\$434.98	\$456.27

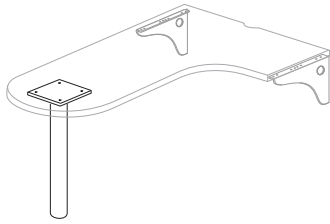

WUCC-0004
Class CA

Features

- Includes one column and mounting screws.
- Column adjusts vertically for worksurface heights from 26"(660mm) to 30"(762mm).
- 3"(76mm)-diameter column includes 6"(152mm)- square top plate.

To Order, Specify:

- 1) Product number.
- 2) Trim color.

Worksurface Supports

	Height (Adjustable)	Depth	Number	Price	
				A	B
Double Support Leg	27"(686mm)	18"(457mm)	ZZFK-1800-PNFG	\$740.27	\$763.22
		24"(610mm)	ZZFK-2400-PNFG	784.47	807.42
		30"(762mm)	ZZFK-3000-PNFG	828.67	851.62



ZZFK Class CA

Features

- Includes one double leg and mounting hardware.
- Leg may be installed in left-hand or right-hand configuration.
- 6" adjustment range allows worksurface heights from 26"(660mm) to 32"(813mm).
- Provides full support for one end of equal depth worksurface.

To Order, Specify:

- 1) Product number.
- 2) Trim color.

Specification Tips

- One end of worksurface must be panel attached, not to be used as freestanding.
- Double leg with glide can be used to replace support post or support column.

Single Support Leg

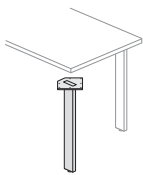

ZUFJ-0101-PNFG Class CA

	Height	Depth	Width	Description	Number	Price	
						A	B
	28"(711mm)	3.25"(83mm)	1.125"(29mm)	Single Post with Glide	ZUFJ-0101-PNFG	\$280.53	\$304.50

Features

- Includes one single post and mounting hardware.
- Glide provides 0.5"(13mm) of height adjustment.

To Order, Specify:

- 1) Product number.
- 2) Trim color.

Specification Tip

- May be used for worksurface applications.
- One end of worksurface must be panel attached, not to be used as freestanding.

Support Post

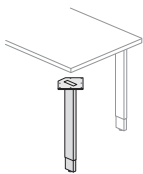

ZZFJ Class CA

	Height (Adjustable)	Description	Number	Price	
				A	B
	26"(660mm)/30"(762mm)	Single post with glide, adjustable	ZZFJ-0101-PNFG	\$397.69	\$420.78

Features

- Includes one single post and mounting hardware.
- 6"(152mm) height adjustment (26"(660mm)-32"(813mm)).

To Order, Specify:

- 1) Product number.
- 2) Trim color.

Specification Tip

- May be used for worksurface and freestanding table applications.

Worksurface Accessories

	Height	Width	Number	Price
Make-A-Corner	21.125"(537mm)	26.125"(664mm)	MAC-0001	\$283.56

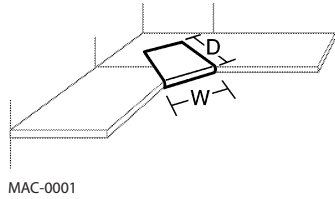

Features

- Creates an angled edge between two (2) perpendicular regular worksurfaces.
- Slides over the top of 1.82"(46mm) thick worksurfaces.
- Accommodates an adjustable keyboard or mouse pad track (screws included).

To Order, Specify:

- 1) Product number.
- 2) Non-metallic trim color.

Adaptable Upper Storage

for use with UniGroup Too, UniGroup, PLACES

	Height	Depth	Width	Number	Laminate A		Laminate B	
					Trim A	Trim B	Trim A	Trim B
Straight Mini Shelf, Standard Mount	4.25"(108mm)	6.25"(159mm)	18"(457mm)	UESY-0418-PM	\$372.73	\$376.50	\$397.36	\$401.13
			24"(610mm)	UESY-0424-PM	390.97	394.74	419.40	423.17
			30"(762mm)	UESY-0430-PM	409.09	412.86	437.52	441.29
			36"(914mm)	UESY-0436-PM	427.34	431.11	457.67	461.44
			42"(1067mm)	UESY-0442-PM	445.46	449.23	477.69	481.46
			48"(1219mm)	UESY-0448-PM	463.58	467.35	497.71	501.48

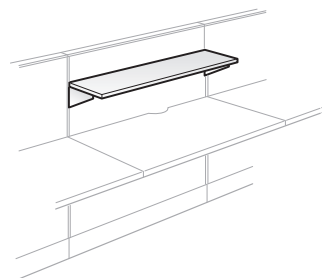

UESY-PM

Features

- Includes shelf, brackets, and hardware.
- Shelf thickness is 0.75"(19mm).
- Shipped unassembled.

Specification Tips

- To be installed in connector slots on same size panel or on a combination of panels that equals the shelf width.
- Support brackets must be installed under shelf surface.
- Designed for lightweight accessories.
- Does not accept separately specified task lights.

To Order, Specify:

- 1) Product number.
- 2) Laminate shelf color.
- 3) Edgeband trim color.
- 4) Trim color for brackets.

Corner Mini Shelf, Standard Mount	4.25"(108mm)	6.25"(159mm)	24"(610mm)	UESZ-0424-PM	\$739.04	\$744.73	\$792.11	\$797.80
			30"(762mm)	UESZ-0430-PM	786.21	791.90	839.28	844.97
			36"(914mm)	UESZ-0436-PM	833.38	839.07	889.31	895.00
			42"(1067mm)	UESZ-0442-PM	880.55	886.24	939.34	945.03
			48"(1219mm)	UESZ-0448-PM	927.72	933.41	989.37	995.06

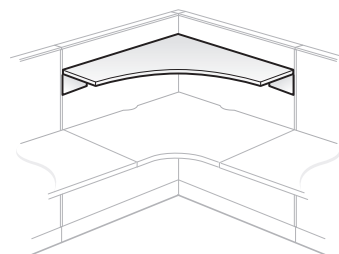

UESZ-PM

Features

- Includes shelf, brackets, and hardware.
- Middle of shelf is 15.25"(387mm) deep.
- Shelf thickness is 0.75"(19mm).
- Shipped unassembled.

Specification Tips

- To be installed in connector slots on two panels or on a combination of panels of equivalent widths in 90° configuration.
- Support brackets must be installed under shelf surface.
- Designed for lightweight accessories.
- Does not accept separately specified task lights.

To Order, Specify:

- 1) Product number.
- 2) Laminate shelf color.
- 3) Edgeband trim color.
- 4) Trim color for brackets.

Mini Shelves with Loop Bracket

for use with UniGroup Too, UniGroup, PLACES

	Height	Depth	Width	Number	Laminate A	Laminate B
Straight Mini-Shelf, with Loop Bracket	5.5"(140mm)	6.25"(159mm)	18"(457mm)	HMSS-0618	\$407.18	\$435.68
			24"(610mm)	HMSS-0624	430.82	461.51
			30"(762mm)	HMSS-0630	454.46	487.34
			36"(914mm)	HMSS-0636	478.10	513.17
			42"(1067mm)	HMSS-0642	501.74	539.00
			48"(1219mm)	HMSS-0648	525.38	564.83



HMSS

Features

- Includes brackets, hardware and mini-shelf.
- Mounts on single or multiple panels of equivalent widths.
- Support bracket may be mounted under shelf surface only.
- Does not accept task lights.

To Order, Specify:

- 1) Product number.
- 2) Laminate shelf color.
- 3) Trim color for brackets.

Specification Tips

- To be installed in connector slots on same size panel or on a combination of panels that equals the shelf width.
- Support brackets must be installed under shelf surface.
- Designed for lightweight accessories.
- Does not accept separately specified task lights.

	Height	Depth	Width	Number	Laminate A	Laminate B
Corner Mini-Shelf, with Loop Bracket	5.5"(140mm)	6.25"(159mm)	24"(610mm) x 24"(610mm)	HMSC-0624	\$ 827.67	\$ 888.50
			30"(762mm) x 30"(762mm)	HMSC-0630	881.60	942.43
			36"(914mm) x 36"(914mm)	HMSC-0636	935.53	999.64
			42"(1067mm) x 42"(1067mm)	HMSC-0642	989.46	1056.85
			48"(1219mm) x 48"(1219mm)	HMSC-0648	1043.39	1114.06

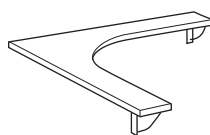

HMSC

Features

- Includes brackets, hardware and corner mini-shelf.
- Mounts on two panels of equivalent widths in 90° configuration.
- Middle of shelf is 16"(406mm) deep.
- Shelf thickness is 0.75"(19mm).
- Support bracket may be mounted under shelf surface only.
- Does not accept task lights.

To Order, Specify:

- 1) Product number.
- 2) Laminate shelf color.
- 3) Edgeband trim color.
- 4) Trim color for brackets.

Specification Tips

- To be installed in connector slots on same size panel or on a combination of panels that equals the shelf width.
- Support brackets must be installed under shelf surface.
- Designed for lightweight accessories.
- Does not accept separately specified task lights.

Adaptable Upper Storage

for use with UniGroup Too, UniGroup, PLACES

	Height	Width	Number	Trim A	B
Open Shelf, Standard Mount	8"(203mm)	24"(610mm)	UESN-0824-PM	\$372.87	\$391.56
		30"(762mm)	UESN-0830-PM	386.19	409.53
		36"(914mm)	UESN-0836-PM	399.51	427.50
		42"(1067mm)	UESN-0842-PM	412.83	445.47
		48"(1219mm)	UESN-0848-PM	426.15	463.44
		54"(1372mm)	UESN-0854-PM	439.47	481.41
		60"(1524mm)	UESN-0860-PM	452.79	499.38
		66"(1676mm)	UESN-0866-PM	466.11	517.35
		72"(1829mm)	UESN-0872-PM	479.43	535.32

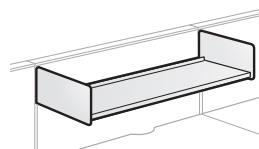

UESN-PM

Features

- Includes shelf with back stop, end panels and hardware.
- Safety interlock prevents dislodgement from panel connector slots.
- Accepts separately specified task lights.
- Shelf thickness is 2"(51mm).
- Shipped unassembled.

To Order, Specify:

- 1) Product number.
- 2) Trim color for shelf and end panels.

Specification Tips

- Specify separate shelf gang clip NUB-1 for unbalanced configurations with greater than one row of shelves.
- To be installed in panel trim rails on same size panel or on a combination of panels that equals the shelf width.

Overhead Storage Unit / Shelf Gang Clip



NUB-1

Description	Number	Price
One clip	NUB-1	\$76.43

Features

- Provides additional stability in unbalanced panel configurations with adjacent shelves and overheads.
- Gangs adaptable style overheads and shelves.
- Standard in black finish.

To Order, Specify:

- 1) Product number.
(No finish specification required.)

Adaptable Upper Storage

for use with UniGroup Too, UniGroup, PLACES

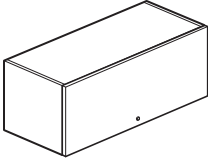
	Height	Depth	Width	Flipper Door Number ① ②	Trim A		Trim B	
					A	B	A	B
Overhead Storage Unit, Standard Mount – Painted Door  UEFS-PM	16"(406mm)	14"(356mm)	24"(610mm)	UEFS-1624-PM	\$1098.32	\$1104.24	\$1114.09	\$1120.01
			30"(762mm)	UEFS-1630-PM	1148.96	1155.88	1166.68	1173.60
			36"(914mm)	UEFS-1636-PM	1199.60	1207.52	1219.27	1227.19
			42"(1067mm)	UEFS-1642-PM	1250.24	1259.16	1271.86	1280.78
			48"(1219mm)	UEFS-1648-PM	1300.88	1310.80	1324.45	1334.37
			54"(1372mm)	UEFS-1654-PM	1351.52	1362.44	1377.04	1387.96
			60"(1524mm)	UEFS-1660-PM	1518.43	1530.35	1545.90	1557.82
			66"(1676mm)	UEFS-1666-PM	1827.26	1840.18	1856.68	1869.60
		72"(1829mm)	UEFS-1672-PM	2153.85	2167.77	2185.22	2199.14	

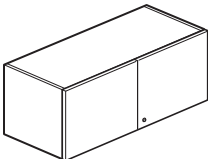
	Height	Depth	Width	Cabinet Door Number ①	Trim A		Trim B	
					A	B	A	B
 UEKS-PM	16"(406mm)	14"(356mm)	24"(610mm)	UEKS-1624-PM	\$1830.13	\$1836.05	\$1845.90	\$1851.82
			30"(762mm)	UEKS-1630-PM	1880.77	1887.69	1898.49	1905.41
			36"(914mm)	UEKS-1636-PM	1931.41	1939.33	1951.08	1959.00
			42"(1067mm)	UEKS-1642-PM	1982.05	1990.97	2003.67	2012.59
			48"(1219mm)	UEKS-1648-PM	2103.05	2112.97	2126.62	2136.54
			54"(1372mm)	UEKS-1654-PM	2286.34	2297.26	2311.86	2322.78
			60"(1524mm)	UEKS-1660-PM	2498.55	2510.47	2526.02	2537.94
			66"(1676mm)	UEKS-1666-PM	3014.36	3027.28	3043.78	3056.70
		72"(1829mm)	UEKS-1672-PM	3478.94	3492.86	3510.31	3524.23	

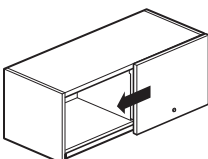
	Height	Depth	Width	Single Slider Door Number ①	Trim A		Trim B	
					A	B	A	B
 UEHS-PM	16"(406mm)	14"(356mm)	24"(610mm)	UEHS-1624-PM	\$1098.32	\$1104.24	\$1114.09	\$1120.01
			30"(762mm)	UEHS-1630-PM	1148.96	1155.88	1166.68	1173.60
			36"(914mm)	UEHS-1636-PM	1199.60	1207.52	1219.27	1227.19
			42"(1067mm)	UEHS-1642-PM	1250.24	1259.16	1271.86	1280.78
			48"(1219mm)	UEHS-1648-PM	1300.88	1310.80	1324.45	1334.37
			54"(1372mm)	UEHS-1654-PM	1351.52	1362.44	1377.04	1387.96
			60"(1524mm)	UEHS-1660-PM	1518.43	1530.35	1545.90	1557.82
			66"(1676mm)	UEHS-1666-PM	1827.26	1840.18	1856.68	1869.60
		72"(1829mm)	UEHS-1672-PM	2153.85	2167.77	2185.22	2199.14	

Features

- Includes door front without lock, top shelf, bottom shelf with back stop, end panels, and hardware. Optional locks available.
- Inside dimensions:
 - Height: 12.75"(324mm)
 - Depth: 13.25"(337mm)
- Locks are available in black or chrome.
- For lock options, refer to Lock Program section of the Accessories Price List.
- Accepts separately specified task lights.
- Safety interlock prevents dislodgement from panel component slots.
- Flipper Door - 66"(1676mm) and 72"(1829mm) units have two doors, one lock per door if locking option is specified.
- Flipper door stores on top of unit.
- Cabinet Door - 24"-42"(610mm-1067mm) units have two cabinet doors with one lock if locking option is specified.
 - 48"-72"(1219mm-1829mm) units have four cabinet doors with two locks if locking option is specified.
- Single Slider Door - Door is half the width of the unit.
- Shipped unassembled.

Specification Tips

- To be installed in component slots on same size panel or on a combination of panels that equal the width of the storage unit.
- Specify separate shelf gang clip for unbalanced configurations with greater than one row of overhead storage units.
- Doors cannot be retrofitted with locks.
- Standard mount overhead storage unit cannot be retrofitted to up mount overhead storage unit.
- Flipper doors can be field retrofitted with slow close mechanism from eParts.

To Order, Specify:

- 1) Product number, including:

① Locking Option:

- N Non-locking
- L Locking, add \$31.53 list.

② Close Option: (Flipper door only)

- S Slow close, add \$516.39 list. 66" and 72" wide units, add \$1032.78 list.
- No specification required for standard close.

- 2) Trim color for shelf and end panels.
- 3) Trim color for door.
- 4) Trim color for lock housing, if applicable.

Adaptable Upper Storage

for use with UniGroup Too, UniGroup, PLACES

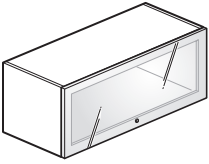
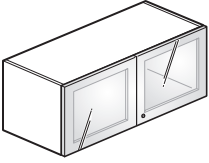
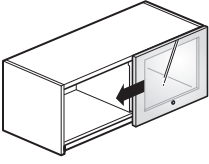
	Height	Depth	Width	Flipper Door Number ① ②	White Trim A	Trim B
Overhead Storage Unit, Standard Mount – Translucent Door  UEFF-QM	16"(406mm)	14"(356mm)	24"(610mm)	UEFF-1624-QM	\$1720.90	\$1736.67
			30"(762mm)	UEFF-1630-QM	1796.86	1814.58
			36"(914mm)	UEFF-1636-QM	1872.82	1892.49
			42"(1067mm)	UEFF-1642-QM	1948.78	1970.40
			48"(1219mm)	UEFF-1648-QM	2024.74	2048.31
			54"(1372mm)	UEFF-1654-QM	2100.70	2126.22
			60"(1524mm)	UEFF-1660-QM	2348.13	2375.60
			66"(1676mm)	UEFF-1666-QM	2875.41	2904.83
		72"(1829mm)	UEFF-1672-QM	3272.67	3304.04	
 UEKF-QM	Height	Depth	Width	Cabinet Door Number ①	White Trim A	Trim B
	16"(406mm)	14"(356mm)	24"(610mm)	UEKF-1624-QM	\$2769.03	\$2784.80
			30"(762mm)	UEKF-1630-QM	2874.48	2892.20
			36"(914mm)	UEKF-1636-QM	2979.93	2999.60
			42"(1067mm)	UEKF-1642-QM	3085.38	3107.00
			48"(1219mm)	UEKF-1648-QM	3225.99	3249.56
			54"(1372mm)	UEKF-1654-QM	3522.96	3548.48
			60"(1524mm)	UEKF-1660-QM	3838.09	3865.56
		66"(1676mm)	UEKF-1666-QM	4612.13	4641.55	
		72"(1829mm)	UEKF-1672-QM	5323.45	5354.82	
 UEHF-QM	Height	Depth	Width	Single Slider Door Number ①	White Trim A	Trim B
	16"(406mm)	14"(356mm)	24"(610mm)	UEHF-1624-QM	\$1720.90	\$1736.67
			30"(762mm)	UEHF-1630-QM	1796.86	1814.58
			36"(914mm)	UEHF-1636-QM	1872.82	1892.49
			42"(1067mm)	UEHF-1642-QM	1948.78	1970.40
			48"(1219mm)	UEHF-1648-QM	2024.74	2048.31
			54"(1372mm)	UEHF-1654-QM	2100.70	2126.22
			60"(1524mm)	UEHF-1660-QM	2348.13	2375.60
		66"(1676mm)	UEHF-1666-QM	2875.41	2904.83	
		72"(1829mm)	UEHF-1672-QM	3272.67	3304.04	

Features

- Includes door front without lock, top shelf, bottom shelf with back stop, end panels, and hardware. Optional locks available.
- Inside dimensions:
 - Height: 12.75"(324mm)
 - Depth: 13.25"(337mm)
- Locks are available in black or chrome.
- For lock options, refer to Lock Program section of the Accessories Price List.
- Accepts separately specified task lights.
- Safety interlock prevents dislodgement from panel component slots.
- Flipper Door - 66"(1676mm) and 72"(1829mm) units have two doors, one lock per door if locking option is specified.
- Flipper door stores on top of unit.
- Cabinet Door - 24"-42"(610mm-1067mm) units have two cabinet doors with one lock if locking option is specified.
 - 48"-72"(1219mm-1829mm) units have four cabinet doors with two locks if locking option is specified.
- Single Slider Door - Door is half the width of the unit.
- Shipped unassembled.

Specification Tips

- To be installed in component slots on same size panel or on a combination of panels that equal the width of the storage unit.
- Specify separate shelf gang clip for unbalanced configurations with greater than one row of overhead storage units.
- Doors cannot be retrofitted with locks.
- Standard mount overhead storage unit cannot be retrofitted to up mount overhead storage unit.
- Flipper doors can be field retrofitted with slow close mechanism from eParts.

To Order, Specify:

- 1) Product number, including:

① Locking Option:

N Non-locking

L Locking, add \$31.53 list.

② Close Option: (Flipper door only)

S Slow close, add \$516.39 list.
66" and 72" wide units,
add \$1032.78 list.

No specification required for standard close.

- 2) Trim color for shelf and end panels.
- 3) Trim color for door.
- 4) Trim color for lock housing, if applicable.

Adaptable Upper Storage

for use with UniGroup Too, UniGroup, PLACES

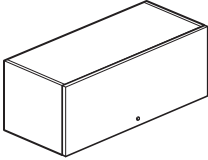
	Height	Depth	Width	Flipper Door Number ① ②	Wood Group A		Wood Group B	
					Trim A	Trim B	Trim A	Trim B
Overhead Storage Unit, Standard Mount – Wood Door  UEFS-WM	16"(406mm)	14"(356mm)	24"(610mm)	UEFS-1624-WM	\$1793.21	\$1808.98	\$1907.52	\$1923.29
			30"(762mm)	UEFS-1630-WM	1874.96	1892.68	1989.27	2006.99
			36"(914mm)	UEFS-1636-WM	1956.71	1976.38	2071.02	2090.69
			42"(1067mm)	UEFS-1642-WM	2038.46	2060.08	2152.77	2174.39
			48"(1219mm)	UEFS-1648-WM	2120.21	2143.78	2234.52	2258.09
			54"(1372mm)	UEFS-1654-WM	2201.96	2227.48	2316.27	2341.79
			60"(1524mm)	UEFS-1660-WM	2524.15	2551.62	2638.46	2665.93
			66"(1676mm)	UEFS-1666-WM	3011.92	3041.34	3126.23	3155.65
		72"(1829mm)	UEFS-1672-WM	3539.13	3570.50	3653.44	3684.81	

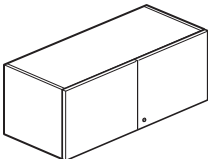
	Height	Depth	Width	Cabinet Door Number ①	Wood Group A		Wood Group B	
					Trim A	Trim B	Trim A	Trim B
 UEKS-WM	16"(406mm)	14"(356mm)	24"(610mm)	UEKS-1624-WM	\$2929.91	\$2945.68	\$3044.22	\$3059.99
			30"(762mm)	UEKS-1630-WM	3023.54	3041.26	3137.85	3155.57
			36"(914mm)	UEKS-1636-WM	3117.17	3136.84	3231.48	3251.15
			42"(1067mm)	UEKS-1642-WM	3210.80	3232.42	3325.11	3346.73
			48"(1219mm)	UEKS-1648-WM	3341.64	3365.21	3455.95	3479.52
			54"(1372mm)	UEKS-1654-WM	3666.11	3691.63	3780.42	3805.94
			60"(1524mm)	UEKS-1660-WM	4011.55	4039.02	4125.86	4153.33
			66"(1676mm)	UEKS-1666-WM	4801.37	4830.79	4915.68	4945.10
		72"(1829mm)	UEKS-1672-WM	5584.90	5616.27	5699.21	5730.58	

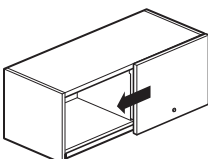
	Height	Depth	Width	Single Slider Door Number ①	Wood Group A		Wood Group B	
					Trim A	Trim B	Trim A	Trim B
 UEHS-WM	16"(406mm)	14"(356mm)	24"(610mm)	UEHS-1624-WM	\$1793.21	\$1808.98	\$1907.52	\$1923.29
			30"(762mm)	UEHS-1630-WM	1874.96	1892.68	1989.27	2006.99
			36"(914mm)	UEHS-1636-WM	1956.71	1976.38	2071.02	2090.69
			42"(1067mm)	UEHS-1642-WM	2038.46	2060.08	2152.77	2174.39
			48"(1219mm)	UEHS-1648-WM	2120.21	2143.78	2234.52	2258.09
			54"(1372mm)	UEHS-1654-WM	2201.96	2227.48	2316.27	2341.79
			60"(1524mm)	UEHS-1660-WM	2524.15	2551.62	2638.46	2665.93
			66"(1676mm)	UEHS-1666-WM	3011.92	3041.34	3126.23	3155.65
		72"(1829mm)	UEHS-1672-WM	3539.13	3570.50	3653.44	3684.81	

Features

- Includes door front without lock, top shelf, bottom shelf with back stop, end panels, and hardware. Optional locks available.
- Inside dimensions:
 - Height: 12.75"(324mm)
 - Depth: 13.25"(337mm)
- Locks are available in black or chrome.
- For lock options, refer to Lock Program section of the Accessories Price List.
- Accepts separately specified task lights.
- Safety interlock prevents dislodgement from panel component slots.
- Flipper Door - 66"(1676mm) and 72"(1829mm) units have two doors, one lock per door if locking option is available.
- Flipper door stores on top of unit.
- Cabinet Door - 24"-42"(610mm-1067mm) units have two cabinet doors with one lock if locking option is specified.
- 48"-72"(1219mm-1829mm) units have four cabinet doors with two locks if locking option is specified.
- Single Slider Door - Door is half the width of the unit.
- Shipped unassembled.

Specification Tips

- To be installed in component slots on same size panel or on a combination of panels that equal the width of the storage unit.
- Specify separate shelf gang clip for unbalanced configurations with greater than one row of overhead storage units.
- Doors cannot be retrofitted with locks.
- Standard mount overhead storage unit cannot be retrofitted to up mount overhead storage unit.
- Flipper doors can be field retrofitted with slow close mechanism from eParts.

To Order, Specify:

1) Product number, including:

① Locking Option:

- N Non-locking
- L Locking, add \$31.53 list.

② Close Option: (Flipper door only)

- S Slow close, add \$516.39 list. 66" and 72" wide units, add \$1032.78 list.
- No specification required for standard close.

- 2) Trim color for shelf and end panels.
- 3) Wood finish for door.
- 4) Trim color for lock housing, if applicable.

Adaptable Upper Storage

for use with UniGroup Too, UniGroup, PLACES

	Height	Depth	Width	Flipper Door Number ① ②	Laminate A		Laminate B	
					Trim A	Trim B	Trim A	Trim B
Overhead Storage Unit, Standard Mount – Laminate Door	16"(406mm)	14"(356mm)	24"(610mm)	UEFS-1624-LM	\$1492.68	\$1508.45	\$1522.27	\$1538.04
			30"(762mm)	UEFS-1630-LM	1580.58	1598.30	1610.17	1627.89
			36"(914mm)	UEFS-1636-LM	1668.48	1688.15	1698.07	1717.74
			42"(1067mm)	UEFS-1642-LM	1756.38	1778.00	1785.97	1807.59
			48"(1219mm)	UEFS-1648-LM	1844.28	1867.85	1873.87	1897.44
			54"(1372mm)	UEFS-1654-LM	1932.18	1957.70	1961.77	1987.29
			60"(1524mm)	UEFS-1660-LM	2140.33	2167.80	2169.92	2197.39
			66"(1676mm)	UEFS-1666-LM	2594.77	2624.19	2624.36	2653.78
		72"(1829mm)	UEFS-1672-LM	3051.26	3082.63	3080.85	3112.22	

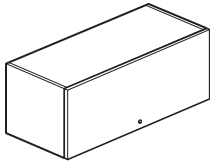

UEFS-LM

	Height	Depth	Width	Cabinet Door Number ①	Laminate A		Laminate B	
					Trim A	Trim B	Trim A	Trim B
	16"(406mm)	14"(356mm)	24"(610mm)	UEKS-1624-LM	\$2540.81	\$2556.58	\$2570.40	\$2586.17
			30"(762mm)	UEKS-1630-LM	2628.71	2646.43	2658.30	2676.02
			36"(914mm)	UEKS-1636-LM	2716.61	2736.28	2746.20	2765.87
			42"(1067mm)	UEKS-1642-LM	2804.51	2826.13	2834.10	2855.72
			48"(1219mm)	UEKS-1648-LM	2930.34	2953.91	2959.93	2983.50
			54"(1372mm)	UEKS-1654-LM	3214.85	3240.37	3244.44	3269.96
			60"(1524mm)	UEKS-1660-LM	3519.56	3547.03	3549.15	3576.62
			66"(1676mm)	UEKS-1666-LM	4210.54	4239.96	4240.13	4269.55
		72"(1829mm)	UEKS-1672-LM	4897.65	4929.02	4927.24	4958.61	

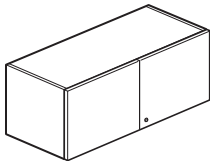

UEKS-LM

	Height	Depth	Width	Single Slider Door Number ①	Laminate A		Laminate B	
					Trim A	Trim B	Trim A	Trim B
	16"(406mm)	14"(356mm)	24"(610mm)	UEHS-1624-LM	\$1492.68	\$1508.45	\$1522.27	\$1538.04
			30"(762mm)	UEHS-1630-LM	1580.58	1598.30	1610.17	1627.89
			36"(914mm)	UEHS-1636-LM	1668.48	1688.15	1698.07	1717.74
			42"(1067mm)	UEHS-1642-LM	1756.38	1778.00	1785.97	1807.59
			48"(1219mm)	UEHS-1648-LM	1844.28	1867.85	1873.87	1897.44
			54"(1372mm)	UEHS-1654-LM	1932.18	1957.70	1961.77	1987.29
			60"(1524mm)	UEHS-1660-LM	2140.33	2167.80	2169.92	2197.39
			66"(1676mm)	UEHS-1666-LM	2594.77	2624.19	2624.36	2653.78
		72"(1829mm)	UEHS-1672-LM	3051.26	3082.63	3080.85	3112.22	

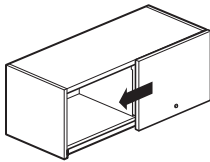

UEHS-LM

Features

- Includes door front without lock, top shelf, bottom shelf with back stop, end panels, and hardware. Optional locks available.
- Inside dimensions:
 - Height: 12.75"(324mm)
 - Depth: 13.25"(337mm)
- Locks are available in black or chrome.
- For lock options, refer to Lock Program section of the Accessories Price List.
- Accepts separately specified task lights.
- Safety interlock prevents dislodgement from panel component slots.
- Flipper Door - 66"(1676mm) and 72"(1829mm) units have two doors, one lock per door if locking option is specified.
- Flipper door stores on top of unit.
- Cabinet Door - 24"-42"(610mm-1067mm) units have two cabinet doors with one lock if locking option is specified.
 - 48"-72"(1219mm-1829mm) units have four cabinet doors with two locks if locking option is specified.
- Single Slider Door - Door is half the width of the unit.
- Shipped unassembled.

Specification Tips

- To be installed in component slots on same size panel or on a combination of panels that equal the width of the storage unit.
- Specify separate shelf gang clip for unbalanced configurations with greater than one row of overhead storage units.
- Doors cannot be retrofitted with locks.
- Standard mount overhead storage unit cannot be retrofitted to up mount overhead storage unit.
- Flipper doors can be field retrofitted with slow close mechanism from eParts.

To Order, Specify:

- 1) Product number, including:
 - ① **Locking Option:**
 - N** Non-locking
 - L** Locking, add \$31.53 list.
 - ② **Close Option: (Flipper door only)**
 - S** Slow close, add \$516.39 list. 66" and 72" wide units, add \$1032.78 list.
 - No specification required for standard close.
- 2) Trim color for shelf and end panels.
- 3) Laminate color for door.
- 4) Edgeband color.
- 5) Trim color for lock housing, if applicable.

Adaptable Upper Storage

for use with UniGroup Too, UniGroup, PLACES

	Height	Depth	Width	Flipper Door Number ¹ ²	Trim A		Trim B	
					A	B	A	B
Overhead Storage Unit, Up Mount – Painted Door	16"(406mm)	14"(356mm)	24"(610mm)	UEGS-1624-PM <input type="checkbox"/>	\$1535.02	\$1540.94	\$1550.79	\$1556.71
			30"(762mm)	UEGS-1630-PM <input type="checkbox"/>	1585.66	1592.58	1603.38	1610.30
			36"(914mm)	UEGS-1636-PM <input type="checkbox"/>	1636.30	1644.22	1655.97	1663.89
			42"(1067mm)	UEGS-1642-PM <input type="checkbox"/>	1686.94	1695.86	1708.56	1717.48
			48"(1219mm)	UEGS-1648-PM <input type="checkbox"/>	1737.58	1747.50	1761.15	1771.07

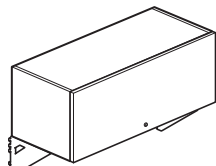

UEGS-PM

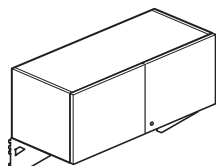

UELS-PM

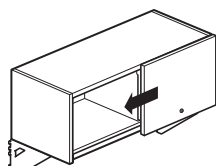

UEJS-PM

	Height	Depth	Width	Cabinet Door Number ¹	Trim A		Trim B	
					A	B	A	B
	16"(406mm)	14"(356mm)	24"(610mm)	UELS-1624-PM <input type="checkbox"/>	\$2593.81	\$2599.73	\$2609.58	\$2615.50
			30"(762mm)	UELS-1630-PM <input type="checkbox"/>	2644.45	2651.37	2662.17	2669.09
			36"(914mm)	UELS-1636-PM <input type="checkbox"/>	2695.09	2703.01	2714.76	2722.68
			42"(1067mm)	UELS-1642-PM <input type="checkbox"/>	2745.73	2754.65	2767.35	2776.27
			48"(1219mm)	UELS-1648-PM <input type="checkbox"/>	2866.73	2876.65	2890.30	2900.22

	Height	Depth	Width	Single Slider Door Number ¹	Trim A		Trim B	
					A	B	A	B
	16"(406mm)	14"(356mm)	24"(610mm)	UEJS-1624-PM <input type="checkbox"/>	\$1535.02	\$1540.94	\$1550.79	\$1556.71
			30"(762mm)	UEJS-1630-PM <input type="checkbox"/>	1585.66	1592.58	1603.38	1610.30
			36"(914mm)	UEJS-1636-PM <input type="checkbox"/>	1636.30	1644.22	1655.97	1663.89
			42"(1067mm)	UEJS-1642-PM <input type="checkbox"/>	1686.94	1695.86	1708.56	1717.48
			48"(1219mm)	UEJS-1648-PM <input type="checkbox"/>	1737.58	1747.50	1761.15	1771.07

Features

- Includes door front without lock, top shelf, bottom shelf with full back, mounting brackets, end panels, and hardware. Optional locks available.
- Inside dimensions:
 - Height: 12.75"(324mm)
 - Depth: 13.25"(337mm)
- Up-Mount brackets are color-matched to case.
- Locks are available in black or chrome.
- For lock options, refer to Lock Program section of the Accessories Price List.
- Accepts separately specified task lights.
- Safety interlock prevents dislodgement from panel component slots.
- Flipper door stores on top of unit.
- Cabinet Door - 24"-42"(610mm-1067mm) units have two cabinet doors with one lock if locking option is specified.
- 48"(1219mm) units have four cabinet doors with two locks if locking option is specified.
- Single Slider Door - Door is half the width of the unit.
- Doors shipped separate - remainder of the unit shipped unassembled.

Specification Tips

- To be installed in component slots on same size panel or on a combination of panels that equal the width of the storage unit.
- Specify separate shelf gang clip for unbalanced configurations with greater than one row of overhead storage units.
- Doors cannot be retrofitted with locks.
- Up mount overhead storage unit cannot be retrofitted to Standard overhead storage unit.
- Recommended for single row application.
- Recommended for use with 48"-56"(1219mm-1422mm) high panel configurations.
- Using up mount overheads limits allowable panel runs to 10 feet maximum and requires worksurfaces use side-mount brackets, worksurface support panels or other form of floor support. (Fully cantilevered worksurfaces are not allowed). Return panels on each end must equal height of panel run and depth of worksurface.
- Cannot be installed above a slat pad, tackboard, markerboard, or add-on glazed panel.
- Flipper doors can be field retrofitted with slow close mechanism from eParts.

To Order, Specify:

1) Product number, including:

1 Locking Option:

- N Non-locking
- L Locking, add \$31.53 list.

2 Close Option: (Flipper door only)

- S Slow close, add \$516.39 list.
- No specification required for standard close.

- 2) Trim color for shelf and end panels.
- 3) Trim color for door.
- 4) Trim color for lock housing, if applicable.

Adaptable Upper Storage

for use with UniGroup Too, UniGroup, PLACES

	Height	Depth	Width	Flipper Door Number ① ②	White Trim A	Trim B
Overhead Storage Unit, Up Mount – Translucent Door	16"(406mm)	14"(356mm)	24"(610mm)	UEGF-1624-QM	\$2407.97	\$2423.74
			30"(762mm)	UEGF-1630-QM	2483.93	2501.65
			36"(914mm)	UEGF-1636-QM	2559.89	2579.56
			42"(1067mm)	UEGF-1642-QM	2635.85	2657.47
			48"(1219mm)	UEGF-1648-QM	2711.81	2735.38
	Height	Depth	Width	Cabinet Door Number ①	White Trim A	Trim B
	16"(406mm)	14"(356mm)	24"(610mm)	UELF-1624-QM	\$3948.65	\$3964.42
			30"(762mm)	UELF-1630-QM	4054.10	4071.82
			36"(914mm)	UELF-1636-QM	4159.55	4179.22
			42"(1067mm)	UELF-1642-QM	4265.00	4286.62
			48"(1219mm)	UELF-1648-QM	4405.61	4429.18
	Height	Depth	Width	Single Slider Door Number ①	White Price	Price
	16"(406mm)	14"(356mm)	24"(610mm)	UEJF-1624-QM	\$2407.97	\$2423.74
			30"(762mm)	UEJF-1630-QM	2483.93	2501.65
			36"(914mm)	UEJF-1636-QM	2559.89	2579.56
			42"(1067mm)	UEJF-1642-QM	2635.85	2657.47
			48"(1219mm)	UEJF-1648-QM	2711.81	2735.38

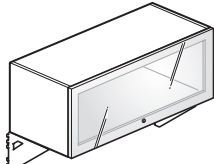

UEGF-QM

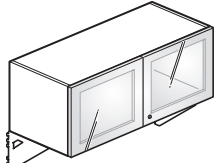

UELF-QM

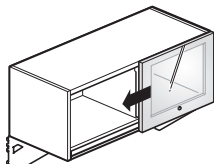

UEJF-QM

Features

- Includes door front without lock, top shelf, bottom shelf with full back, mounting brackets, end panels, and hardware. Optional locks available.
- Inside dimensions:
 - Height: 12.75"(324mm)
 - Depth: 13.25"(337mm)
- Up-Mount brackets are color-matched to case.
- Locks are available in black or chrome.
- For lock options, refer to Lock Program section of the Accessories Price List.
- Accepts separately specified task lights.
- Safety interlock prevents dislodgement from panel component slots.
- Flipper door stores on top of unit.
- Cabinet Door - 24"-42"(610mm-1067mm) units have two cabinet doors with one lock if locking option is specified.
- 48"(1219mm) units have four cabinet doors with two locks if locking option is specified.
- Single Slider Door - Door is half the width of the unit.
- Doors shipped separate - remainder of the unit shipped unassembled.

Specification Tips

- To be installed in component slots on same size panel or on a combination of panels that equal the width of the storage unit.
- Specify separate shelf gang clip for unbalanced configurations with greater than one row of overhead storage units.
- Doors cannot be retrofitted with locks.
- Up mount overhead storage unit cannot be retrofitted to Standard overhead storage unit.
- Recommended for single row application.
- Recommended for use with 48"-56"(1219mm-1422mm) high panel configurations.
- Using up mount overheads limits allowable panel runs to 10 feet maximum and requires worksurfaces use side-mount brackets, worksurface support panels or other form of floor support. (Fully cantilevered worksurfaces are not allowed). Return panels on each end must equal height of panel run and depth of worksurface.
- Cannot be installed above a slat pad, tackboard, markerboard, or add-on glazed panel.
- Flipper doors can be field retrofitted with slow close mechanism from eParts.

To Order, Specify:

- 1) Product number, including:

① Locking Option:

N Non-locking

L Locking, add \$31.53 list.

② Close Option: (Flipper door only)

S Slow close, add \$516.39 list.

■ No specification required for standard close.

- 2) Trim color for shelf and end panels.
- 3) Translucent color for door.
- 4) Trim color for lock housing, if applicable.

Adaptable Upper Storage

for use with UniGroup Too, UniGroup, PLACES

	Height	Depth	Width	Flipper Door Number	Wood Group A		Wood Group B	
					Trim A	B	Trim B A	B
Overhead Storage Unit, Up Mount – Wood Door	16"(406mm)	14"(356mm)	24"(610mm)	UEGS-1624-WM	\$2449.26	\$2465.03	\$2563.57	\$2579.34
			30"(762mm)	UEGS-1630-WM	2531.01	2548.73	2645.32	2663.04
			36"(914mm)	UEGS-1636-WM	2612.76	2632.43	2727.07	2746.74
			42"(1067mm)	UEGS-1642-WM	2694.51	2716.13	2808.82	2830.44
			48"(1219mm)	UEGS-1648-WM	2776.26	2799.83	2890.57	2914.14
	Height	Depth	Width	Cabinet Door Number	Trim A A	B	Trim B A	B
 UEGS-WM	16"(406mm)	14"(356mm)	24"(610mm)	UELS-1624-WM	\$4175.74	\$4191.51	\$4290.05	\$4305.82
			30"(762mm)	UELS-1630-WM	4269.37	4287.09	4383.68	4401.40
			36"(914mm)	UELS-1636-WM	4363.00	4382.67	4477.31	4496.98
			42"(1067mm)	UELS-1642-WM	4456.63	4478.25	4570.94	4592.56
			48"(1219mm)	UELS-1648-WM	4587.47	4611.04	4701.78	4725.35
	Height	Depth	Width	Single Slider Door Number	Trim A A	B	Trim B A	B
 UEJS-WM	16"(406mm)	14"(356mm)	24"(610mm)	UEJS-1624-WM	\$2449.26	\$2465.03	\$2563.57	\$2579.34
			30"(762mm)	UEJS-1630-WM	2531.01	2548.73	2645.32	2663.04
			36"(914mm)	UEJS-1636-WM	2612.76	2632.43	2727.07	2746.74
			42"(1067mm)	UEJS-1642-WM	2694.51	2716.13	2808.82	2830.44
			48"(1219mm)	UEJS-1648-WM	2776.26	2799.83	2890.57	2914.14

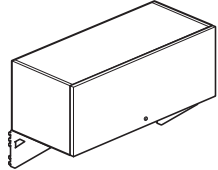

UEGS-WM

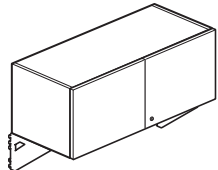

UEJS-WM

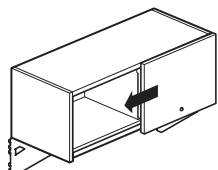

UEJS-WM

Features

- Includes door front without lock, top shelf, bottom shelf with full back, mounting brackets, end panels, and hardware. Optional locks available.
- Inside dimensions:
–Height: 12.75"(324mm)
–Depth: 13.25"(337mm)
- Up-Mount brackets are color-matched to case.
- Locks are available in black or chrome.
- For lock options, refer to Lock Program section of the Accessories Price List.
- Accepts separately specified task lights.
- Safety interlock prevents dislodgement from panel component slots.
- Flipper door stores on top of unit.
- Cabinet Door - 24"-42"(610mm-1067mm) units have two cabinet doors with one lock if locking option is specified.
– 48"(1219mm) units have four cabinet doors with two locks if locking option is specified.
- Single Slider Door - Door is half the width of the unit.
- Doors shipped separate - remainder of the unit shipped unassembled.

Specification Tips

- To be installed in component slots on same size panel or on a combination of panels that equal the width of the storage unit.
- Specify separate shelf gang clip for unbalanced configurations with greater than one row of overhead storage units.
- Doors cannot be retrofitted with locks.
- Up mount overhead storage unit cannot be retrofitted to Standard overhead storage unit.
- Recommended for single row application.
- Recommended for use with 48"-56"(1219mm-1422mm) high panel configurations.
- Using up mount overheads limits allowable panel runs to 10 feet maximum and requires worksurfaces use side-mount brackets, worksurface support panels or other form of floor support. (Fully cantilevered worksurfaces are not allowed). Return panels on each end must equal height of panel run and depth of worksurface.
- Cannot be installed above a slat pad, tackboard, markerboard, or add-on glazed panel.
- Flipper doors can be field retrofitted with slow close mechanism from eParts.

To Order, Specify:

1) Product number, including:

① Locking Option:

- N Non-locking
- L Locking, add \$31.53 list.

② Close Option: (Flipper door only)

- S Slow close, add \$516.39 list.
- No specification required for standard close.

- 2) Trim color for shelf and end panels.
- 3) Wood finish for door.
- 4) Trim color for lock housing, if applicable.

Adaptable Upper Storage

for use with UniGroup Too, UniGroup, PLACES

Overhead Storage Unit, Up Mount – Laminate Door

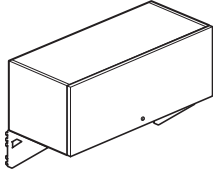

UEGS-LM

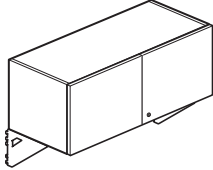

UELS-LM

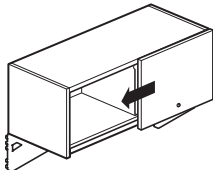

UEJS-LM

Height	Depth	Width	Flipper Door Number ① ②	Laminate A		Laminate B	
				Trim A	Trim B	Trim A	Trim B
16"(406mm)	14"(356mm)	24"(610mm)	UEGS-1624-LM	\$2119.77	\$2135.54	\$2149.36	\$2165.13
		30"(762mm)	UEGS-1630-LM	2207.67	2225.39	2237.26	2254.98
		36"(914mm)	UEGS-1636-LM	2295.57	2315.24	2325.16	2344.83
		42"(1067mm)	UEGS-1642-LM	2383.47	2405.09	2413.06	2434.68
		48"(1219mm)	UEGS-1648-LM	2471.37	2494.94	2500.96	2524.53

Height	Depth	Width	Cabinet Door Number ①	Laminate A		Laminate B	
				Trim A	Trim B	Trim A	Trim B
16"(406mm)	14"(356mm)	24"(610mm)	UELS-1624-LM	\$3633.54	\$3649.31	\$3663.13	\$3678.90
		30"(762mm)	UELS-1630-LM	3721.44	3739.16	3751.03	3768.75
		36"(914mm)	UELS-1636-LM	3809.34	3829.01	3838.93	3858.60
		42"(1067mm)	UELS-1642-LM	3897.24	3918.86	3926.83	3948.45
		48"(1219mm)	UELS-1648-LM	4023.07	4046.64	4052.66	4076.23

Height	Depth	Width	Single Slider Door Number ①	Laminate A		Laminate B	
				Trim A	Trim B	Trim A	Trim B
16"(406mm)	14"(356mm)	24"(610mm)	UEJS-1624-LM	\$2119.77	\$2135.54	\$2149.36	\$2165.13
		30"(762mm)	UEJS-1630-LM	2207.67	2225.39	2237.26	2254.98
		36"(914mm)	UEJS-1636-LM	2295.57	2315.24	2325.16	2344.83
		42"(1067mm)	UEJS-1642-LM	2383.47	2405.09	2413.06	2434.68
		48"(1219mm)	UEJS-1648-LM	2471.37	2494.94	2500.96	2524.53

Features

- Includes door front without lock, top shelf, bottom shelf with full back, mounting brackets, end panels, and hardware. Optional locks available.
- Inside dimensions:
–Height: 12.75"(324mm)
–Depth: 13.25"(337mm)
- Up-Mount brackets are color-matched to case.
- Locks are available in black or chrome.
- For lock options, refer to Lock Program section of the Accessories Price List.
- Accepts separately specified task lights.
- Safety interlock prevents dislodgement from panel component slots.
- Flipper door stores on top of unit.
- Cabinet Door - 24"-42"(610mm-1067mm) units have two cabinet doors with one lock if locking option is specified.
– 48"(1219mm) units have four cabinet doors with two locks if locking option is specified.
- Single Slider Door - Door is half the width of the unit.
- Doors shipped separate - remainder of the unit shipped unassembled.

Specification Tips

- To be installed in component slots on same size panel or on a combination of panels that equal the width of the storage unit.
- Specify separate shelf gang clip for unbalanced configurations with greater than one row of overhead storage units.
- Doors cannot be retrofitted with locks.
- Up mount overhead storage unit cannot be retrofitted to Standard overhead storage unit.
- Recommended for single row application.
- Recommended for use with 48"-56"(1219mm-1422mm) high panel configurations.
- Using up mount overheads limits allowable panel runs to 10 feet maximum and requires worksurfaces use side-mount brackets, worksurface support panels or other form of floor support. (Fully cantilevered worksurfaces are not allowed). Return panels on each end must equal height of panel run and depth of worksurface.
- Cannot be installed above a slat pad, tackboard, markerboard, or add-on glazed panel.
- Flipper doors can be field retrofitted with slow close mechanism from eParts.

To Order, Specify:

1) Product number, including:

① Locking Option:

N Non-locking

L Locking, add \$31.53 list.

② Close Option: (Flipper door only)

S Slow close, add \$516.39 list.

■ No specification required for standard close.

2) Trim color for shelf and end panels.

3) Laminate color for door.

4) Edgeband color.

5) Trim color for lock housing, if applicable.

Wall Mount Components

for use with UniGroup Too, UniGroup, PLACES

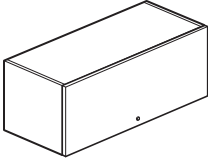
	Height	Depth	Width	Flipper Door Number ① ②	Trim A		Trim B	
					A	B	A	B
Overhead Storage Unit, Wall Mount – Painted Door  UUFS-PW	16"(406mm)	14"(356mm)	24"(610mm)	UUFS-1624-PW	\$1183.15	\$1189.07	\$1198.92	\$1204.84
			30"(762mm)	UUFS-1630-PW	1233.79	1240.71	1251.51	1258.43
			36"(914mm)	UUFS-1636-PW	1284.43	1292.35	1304.10	1312.02
			42"(1067mm)	UUFS-1642-PW	1335.07	1343.99	1356.69	1365.61
			48"(1219mm)	UUFS-1648-PW	1385.71	1395.63	1409.28	1419.20
			54"(1372mm)	UUFS-1654-PW	1436.35	1447.27	1461.87	1472.79
			60"(1524mm)	UUFS-1660-PW	1603.26	1615.18	1630.73	1642.65
			66"(1676mm)	UUFS-1666-PW	1912.09	1925.01	1941.51	1954.43
		72"(1829mm)	UUFS-1672-PW	2238.68	2252.60	2270.05	2283.97	

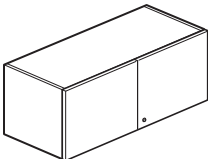
	Height	Depth	Width	Cabinet Door Number ①	Trim A		Trim B	
					A	B	A	B
 UUKS-PW	16"(406mm)	14"(356mm)	24"(610mm)	UUKS-1624-PW	\$1914.96	\$1920.88	\$1930.73	\$1936.65
			30"(762mm)	UUKS-1630-PW	1965.60	1972.52	1983.32	1990.24
			36"(914mm)	UUKS-1636-PW	2016.24	2024.16	2035.91	2043.83
			42"(1067mm)	UUKS-1642-PW	2066.88	2075.80	2088.50	2097.42
			48"(1219mm)	UUKS-1648-PW	2187.88	2197.80	2211.45	2221.37
			54"(1372mm)	UUKS-1654-PW	2371.17	2382.09	2396.69	2407.61
			60"(1524mm)	UUKS-1660-PW	2583.38	2595.30	2610.85	2622.77
			66"(1676mm)	UUKS-1666-PW	3099.19	3112.11	3128.61	3141.53
		72"(1829mm)	UUKS-1672-PW	3563.77	3577.69	3595.14	3609.06	

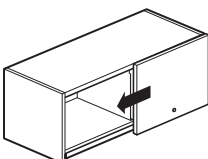
	Height	Depth	Width	Single Slider Door Number ①	Trim A		Trim B	
					A	B	A	B
 UUHS-PW	16"(406mm)	14"(356mm)	24"(610mm)	UUHS-1624-PW	\$1183.15	\$1189.07	\$1198.92	\$1204.84
			30"(762mm)	UUHS-1630-PW	1233.79	1240.71	1251.51	1258.43
			36"(914mm)	UUHS-1636-PW	1284.43	1292.35	1304.10	1312.02
			42"(1067mm)	UUHS-1642-PW	1335.07	1343.99	1356.69	1365.61
			48"(1219mm)	UUHS-1648-PW	1385.71	1395.63	1409.28	1419.20
			54"(1372mm)	UUHS-1654-PW	1436.35	1447.27	1461.87	1472.79
			60"(1524mm)	UUHS-1660-PW	1603.26	1615.18	1630.73	1642.65
			66"(1676mm)	UUHS-1666-PW	1912.09	1925.01	1941.51	1954.43
		72"(1829mm)	UUHS-1672-PW	2238.68	2252.60	2270.05	2283.97	

Features

- Includes door front without lock, top shelf, bottom shelf with back stop, end panels, wall attachment bar, angle attachment bracket and hardware. Optional locks available.
- Inside dimensions:
 - Height: 12.75"(324mm)
 - Depth: 13.25"(337mm)
- Locks are available in black or chrome.
- For lock options, refer to Lock Program section of the Accessories Price List.
- Accepts separately specified task lights.
- Safety interlock prevents dislodgement from wall.
- Flipper Door - 66"(1676mm) and 72"(1829mm) units have two doors, one lock per door if locking option is specified.
- Flipper door stores on top of unit.
- Cabinet Door - 24"-42"(610mm-1067mm) units have two cabinet doors with one lock if locking option is specified.
 - 48"-72"(1219mm-1829mm) units have four cabinet doors with two locks if locking option is specified.
- Single Slider Door - Door is half the width of the unit.
- Optional non-structural back is available.
- Shipped unassembled.

Specification Tips

- Doors cannot be retrofitted with locks.
- Must be properly anchored to a structural wall.
- Anchors are not provided, must be field supplied.
- Flipper doors can be field retrofitted with slow close mechanism from eParts.
- Wall mount overhead storage units cannot be retrofitted to:
 - Upmount overhead storage unit
 - Standard overhead storage unit

To Order, Specify:

1) Product number, including:

① Locking Option:

- N Non-locking
- L Locking, add \$31.53 list.

② Close Option: (Flipper door only)

- S Slow close, add \$516.39 list. 66" and 72" wide units, add \$1032.78 list.
- No specification required for standard close.

- 2) Trim color for shelf and end panels.
- 3) Trim color for door.
- 4) Trim color for lock housing, if applicable.

Wall Mount Components

for use with UniGroup Too, UniGroup, PLACES

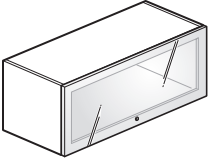
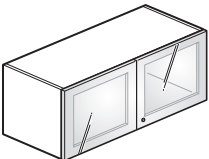
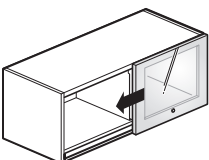
	Height	Depth	Width	Flipper Door Number ① ②	White Trim A	Trim B
Overhead Storage Unit, Wall Mount – Translucent Door  UUFF-QW	16"(406mm)	14"(356mm)	24"(610mm)	UUFF-1624-QW	\$2091.43	\$2107.20
			30"(762mm)	UUFF-1630-QW	2167.39	2185.11
			36"(914mm)	UUFF-1636-QW	2243.35	2263.02
			42"(1067mm)	UUFF-1642-QW	2319.31	2340.93
			48"(1219mm)	UUFF-1648-QW	2395.27	2418.84
			54"(1372mm)	UUFF-1654-QW	2471.23	2496.75
			60"(1524mm)	UUFF-1660-QW	2718.66	2746.13
			66"(1676mm)	UUFF-1666-QW	3245.94	3275.36
		72"(1829mm)	UUFF-1672-QW	3643.20	3674.57	
 UUKF-QW	Height	Depth	Width	Cabinet Door Number ①	White Trim A	Trim B
	16"(406mm)	14"(356mm)	24"(610mm)	UUKF-1624-QW	\$3139.56	\$3155.33
			30"(762mm)	UUKF-1630-QW	3245.01	3262.73
			36"(914mm)	UUKF-1636-QW	3350.46	3370.13
			42"(1067mm)	UUKF-1642-QW	3455.91	3477.53
			48"(1219mm)	UUKF-1648-QW	3596.52	3620.09
			54"(1372mm)	UUKF-1654-QW	3893.49	3919.01
			60"(1524mm)	UUKF-1660-QW	4208.62	4236.09
		66"(1676mm)	UUKF-1666-QW	4982.66	5012.08	
		72"(1829mm)	UUKF-1672-QW	5693.98	5725.35	
 UUHF-QW	Height	Depth	Width	Single Slider Door Number ①	White Trim A	Trim B
	16"(406mm)	14"(356mm)	24"(610mm)	UUHF-1624-QW	\$2091.43	\$2107.20
			30"(762mm)	UUHF-1630-QW	2167.39	2185.11
			36"(914mm)	UUHF-1636-QW	2243.35	2263.02
			42"(1067mm)	UUHF-1642-QW	2319.31	2340.93
			48"(1219mm)	UUHF-1648-QW	2395.27	2418.84
			54"(1372mm)	UUHF-1654-QW	2471.23	2496.75
			60"(1524mm)	UUHF-1660-QW	2718.66	2746.13
		66"(1676mm)	UUHF-1666-QW	3245.94	3275.36	
		72"(1829mm)	UUHF-1672-QW	3643.20	3674.57	

Features

- Includes door front without lock, top shelf, bottom shelf with back stop, end panels, wall attachment bar, angle attachment bracket and hardware. Optional locks available.
- Inside dimensions:
 - Height: 12.75"(324mm)
 - Depth: 13.25"(337mm)
- Locks are available in black or chrome.
- For lock options, refer to Lock Program section of the Accessories Price List.
- Accepts separately specified task lights.
- Safety interlock prevents dislodgement from wall.
- Flipper Door - 66"(1676mm) and 72"(1829mm) units have two doors, one lock per door if locking option is specified.
- Flipper door stores on top of unit.
- Cabinet Door - 24"-42"(610mm-1067mm) units have two cabinet doors with one lock if locking option is specified.
 - 48"-72"(1219mm-1829mm) units have four cabinet doors with two locks if locking option is specified.
- Single Slider Door - Door is half the width of the unit.
- Optional non-structural back is available.
- Shipped unassembled.

Specification Tips

- Doors cannot be retrofitted with locks.
- Must be properly anchored to a structural wall.
- Anchors are not provided, must be field supplied.
- Flipper doors can be field retrofitted with slow close mechanism from eParts.
- Wall mount overhead storage units cannot be retrofitted to:
 - Upmount overhead storage unit
 - Standard overhead storage unit

To Order, Specify:

- 1) Product number, including:

① Locking Option:

- N Non-locking
- L Locking, add \$31.53 list.

② Close Option: (Flipper door only)

- S Slow close, add \$516.39 list. 66" and 72" wide units, add \$1032.78 list.
- No specification required for standard close.

- 2) Trim color for shelf and end panels.
- 3) Translucent color for door.
- 4) Trim color for lock housing, if applicable.

Wall Mount Components

for use with UniGroup Too, UniGroup, PLACES

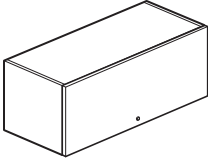
	Height	Depth	Width	Flipper Door Number	Wood Group A		Wood Group B	
					Trim A	Trim B	Trim A	Trim B
Overhead Storage Unit, Wall Mount – Wood Door  UUFS-WW	16"(406mm)	14"(356mm)	24"(610mm)	UUFS-1624-WW	\$2049.42	\$2065.19	\$2163.73	\$2179.50
			30"(762mm)	UUFS-1630-WW	2131.17	2148.89	2245.48	2263.20
			36"(914mm)	UUFS-1636-WW	2212.92	2232.59	2327.23	2346.90
			42"(1067mm)	UUFS-1642-WW	2294.67	2316.29	2408.98	2430.60
			48"(1219mm)	UUFS-1648-WW	2376.42	2399.99	2490.73	2514.30
			54"(1372mm)	UUFS-1654-WW	2458.17	2483.69	2572.48	2598.00
			60"(1524mm)	UUFS-1660-WW	2780.36	2807.83	2894.67	2922.14
			66"(1676mm)	UUFS-1666-WW	3268.13	3297.55	3382.44	3411.86
		72"(1829mm)	UUFS-1672-WW	3795.34	3826.71	3909.65	3941.02	

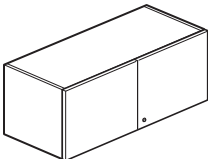
	Height	Depth	Width	Cabinet Door Number	Wood Group A		Wood Group B	
					Trim A	Trim B	Trim A	Trim B
 UUKS-WW	16"(406mm)	14"(356mm)	24"(610mm)	UUKS-1624-WW	\$3379.30	\$3395.07	\$3493.61	\$3509.38
			30"(762mm)	UUKS-1630-WW	3472.93	3490.65	3587.24	3604.96
			36"(914mm)	UUKS-1636-WW	3566.56	3586.23	3680.87	3700.54
			42"(1067mm)	UUKS-1642-WW	3660.19	3681.81	3774.50	3796.12
			48"(1219mm)	UUKS-1648-WW	3791.03	3814.60	3905.34	3928.91
			54"(1372mm)	UUKS-1654-WW	4115.50	4141.02	4229.81	4255.33
			60"(1524mm)	UUKS-1660-WW	4460.94	4488.41	4575.25	4602.72
			66"(1676mm)	UUKS-1666-WW	5250.76	5280.18	5365.07	5394.49
		72"(1829mm)	UUKS-1672-WW	6034.29	6065.66	6148.60	6179.97	

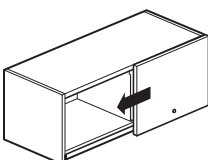
	Height	Depth	Width	Single Slider Door Number	Wood Group A		Wood Group B	
					Trim A	Trim B	Trim A	Trim B
 UUHS-WW	16"(406mm)	14"(356mm)	24"(610mm)	UUHS-1624-WW	\$2049.42	\$2065.19	\$2163.73	\$2179.50
			30"(762mm)	UUHS-1630-WW	2131.17	2148.89	2245.48	2263.20
			36"(914mm)	UUHS-1636-WW	2212.92	2232.59	2327.23	2346.90
			42"(1067mm)	UUHS-1642-WW	2294.67	2316.29	2408.98	2430.60
			48"(1219mm)	UUHS-1648-WW	2376.42	2399.99	2490.73	2514.30
			54"(1372mm)	UUHS-1654-WW	2458.17	2483.69	2572.48	2598.00
			60"(1524mm)	UUHS-1660-WW	2780.36	2807.83	2894.67	2922.14
			66"(1676mm)	UUHS-1666-WW	3268.13	3297.55	3382.44	3411.86
		72"(1829mm)	UUHS-1672-WW	3795.34	3826.71	3909.65	3941.02	

Features

- Includes door front without lock, top shelf, bottom shelf with back stop, end panels, wall attachment bar, angle attachment bracket and hardware. Optional locks available.
- Inside dimensions:
 - Height: 12.75"(324mm)
 - Depth: 13.25"(337mm)
- Locks are available in black or chrome.
- For lock options, refer to Lock Program section of the Accessories Price List.
- Accepts separately specified task lights.
- Safety interlock prevents dislodgement from wall.
- Flipper Door - 66"(1676mm) and 72"(1829mm) units have two doors, one lock per door if locking option is specified.
- Flipper door stores on top of unit.
- Cabinet Door - 24"-42"(610mm-1067mm) units have two cabinet doors with one lock if locking option is specified.
 - 48"-72"(1219mm-1829mm) units have four cabinet doors with two locks if locking option is specified.
- Single Slider Door - Door is half the width of the unit.
- Optional non-structural back is available.
- Shipped unassembled.

Specification Tips

- Doors cannot be retrofitted with locks.
- Must be properly anchored to a structural wall.
- Anchors are not provided, must be field supplied.
- Flipper doors can be field retrofitted with slow close mechanism from eParts.
- Wall mount overhead storage units cannot be retrofitted to:
 - Upmount overhead storage unit
 - Standard overhead storage unit

To Order, Specify:

- 1) Product number, including:

① Locking Option:

- N Non-locking
- L Locking, add \$31.53 list.

② Close Option: (Flipper door only)

- S Slow close, add \$516.39 list. 66" and 72" wide units, add \$1032.78 list.
- No specification required for standard close.

- 2) Trim color for shelf and end panels.
- 3) Wood finish for door.
- 4) Trim color for lock housing, if applicable.

Wall Mount Components

for use with UniGroup Too, UniGroup, PLACES

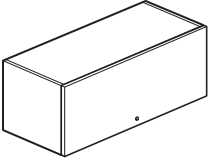
	Height	Depth	Width	Flipper Door Number ① ②	Laminate A		Laminate B	
					Trim A	Trim B	Trim A	Trim B
Overhead Storage Unit, Wall Mount – Laminate Door  UUFS-LW	16"(406mm)	14"(356mm)	24"(610mm)	UUFS-1624-LW	\$1772.10	\$1787.87	\$1801.69	\$1817.46
			30"(762mm)	UUFS-1630-LW	1860.00	1877.72	1889.59	1907.31
			36"(914mm)	UUFS-1636-LW	1947.90	1967.57	1977.49	1997.16
			42"(1067mm)	UUFS-1642-LW	2035.80	2057.42	2065.39	2087.01
			48"(1219mm)	UUFS-1648-LW	2123.70	2147.27	2153.29	2176.86
			54"(1372mm)	UUFS-1654-LW	2211.60	2237.12	2241.19	2266.71
			60"(1524mm)	UUFS-1660-LW	2419.75	2447.22	2449.34	2476.81
			66"(1676mm)	UUFS-1666-LW	2874.19	2903.61	2903.78	2933.20
		72"(1829mm)	UUFS-1672-LW	3330.68	3362.05	3360.27	3391.64	

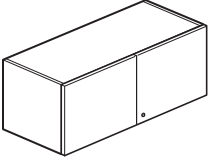
	Height	Depth	Width	Cabinet Door Number ①	Laminate A		Laminate B	
					Trim A	Trim B	Trim A	Trim B
 UUKS-LW	16"(406mm)	14"(356mm)	24"(610mm)	UUKS-1624-LW	\$2820.23	\$2836.00	\$2849.82	\$2865.59
			30"(762mm)	UUKS-1630-LW	2908.13	2925.85	2937.72	2955.44
			36"(914mm)	UUKS-1636-LW	2996.03	3015.70	3025.62	3045.29
			42"(1067mm)	UUKS-1642-LW	3083.93	3105.55	3113.52	3135.14
			48"(1219mm)	UUKS-1648-LW	3209.76	3233.33	3239.35	3262.92
			54"(1372mm)	UUKS-1654-LW	3494.27	3519.79	3523.86	3549.38
			60"(1524mm)	UUKS-1660-LW	3798.98	3826.45	3828.57	3856.04
			66"(1676mm)	UUKS-1666-LW	4489.96	4519.38	4519.55	4548.97
		72"(1829mm)	UUKS-1672-LW	5177.07	5208.44	5206.66	5238.03	

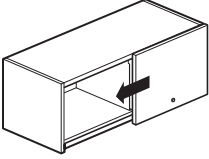
	Height	Depth	Width	Single Slider Door Number ①	Laminate A		Laminate B	
					Trim A	Trim B	Trim A	Trim B
 UUHS-LW	16"(406mm)	14"(356mm)	24"(610mm)	UUHS-1624-LW	\$1772.10	\$1787.87	\$1801.69	\$1817.46
			30"(762mm)	UUHS-1630-LW	1860.00	1877.72	1889.59	1907.31
			36"(914mm)	UUHS-1636-LW	1947.90	1967.57	1977.49	1997.16
			42"(1067mm)	UUHS-1642-LW	2035.80	2057.42	2065.39	2087.01
			48"(1219mm)	UUHS-1648-LW	2123.70	2147.27	2153.29	2176.86
			54"(1372mm)	UUHS-1654-LW	2211.60	2237.12	2241.19	2266.71
			60"(1524mm)	UUHS-1660-LW	2419.75	2447.22	2449.34	2476.81
			66"(1676mm)	UUHS-1666-LW	2874.19	2903.61	2903.78	2933.20
		72"(1829mm)	UUHS-1672-LW	3330.68	3362.05	3360.27	3391.64	

Features

- Includes door front without lock, top shelf, bottom shelf with back stop, end panels, wall attachment bar, angle attachment bracket and hardware. Optional locks available.
- Inside dimensions:
–Height: 12.75"(324mm)
–Depth: 13.25"(337mm)
- Locks are available in black or chrome.
- For lock options, refer to Lock section of the Accessories Program Price List.
- Accepts separately specified task lights.
- Safety interlock prevents dislodgement from wall.
- Flipper Door - 66"(1676mm) and 72"(1829mm) units have two doors, one lock per door if locking option is specified.
- Flipper door stores on top of unit.
- Cabinet Door - 24"-42"(610mm-1067mm) units have two cabinet doors with one lock if locking option is specified.
– 48"-72"(1219mm-1829mm) units have four cabinet doors with two locks if locking option is specified.
- Single Slider Door - Door is half the width of the unit.
- Optional non-structural back is available.
- Shipped unassembled.

Specification Tips

- Doors cannot be retrofitted with locks.
- Must be properly anchored to a structural wall.
- Anchors are not provided, must be field supplied.
- Flipper doors can be field retrofitted with slow close mechanism from eParts.
- Wall mount overhead storage units cannot be retrofitted to:
–Upmount overhead storage unit
–Standard overhead storage unit

To Order, Specify:

- 1) Product number, including:
 - ① **Locking Option:**
 - N** Non-locking
 - L** Locking, add \$31.53 list.
 - ② **Close Option: (Flipper door only)**
 - S** Slow close, add \$516.39 list.
66" and 72" wide units, add \$1032.78 list.
 - No specification required for standard close.
- 2) Trim color for shelf and end panels.
- 3) Laminate color for door.
- 4) Edgeband color.
- 5) Trim color for lock housing, if applicable.

Shelf Accessories

	Height	Depth	Width	Number	Trim	
					A	B
Adaptable Shelf Dividers	4"(102mm)	13.25"(337mm)	1.75"(44mm)	NADR-8	\$345.87	\$369.99

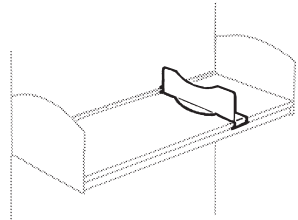

NADR-8
Class CA

Features

- Includes box of eight shelf dividers.
- To be used to divide space laterally on panel mounted shelves or up mount shelves, standard or up mount overhead storage units, or vertical storage units, Adaptable open shelf and Adaptable overhead storage unit.

To Order, Specify:

- 1) Product number.
- 2) Trim color.

Wall Track

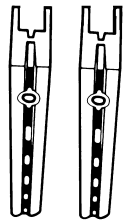

WT
Class AA

	Height	Depth	Width	Number	Trim	
					A	B
	60"(1524mm)	0.75"(19mm)	0.625"(16mm)	WT-60	\$233.74	\$245.38
	72"(1829mm)			WT-72	274.42	286.06
	84"(2134mm)			WT-84	315.10	326.74

Features

- Includes two wall tracks and attachment screws (#10 2.5"(64mm) long).
- For attachment of components to structural walls.
- See installation instructions for proper mounting.

To Order, Specify:

- 1) Product number.
- 2) Trim color for track.

Specification Tip

- Not for use with up-mount overhead storage unit.

Wall Mount Components

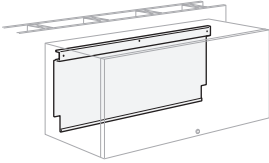
	Outside Height	Width	Number	Trim	
				A	B
 <p>UUFB-P</p>	16"(406mm)	24"(610mm)	UUFB-0024-P	\$416.97	\$459.42
		30"(762mm)	UUFB-0030-P	426.70	469.15
		36"(914mm)	UUFB-0036-P	436.43	478.88
		42"(1067mm)	UUFB-0042-P	446.16	488.61
		48"(1219mm)	UUFB-0048-P	455.89	498.34
		54"(1372mm)	UUFB-0054-P	465.62	508.07
		60"(1524mm)	UUFB-0060-P	475.35	517.80
		66"(1676mm)	UUFB-0066-P	485.08	527.53
		72"(1829mm)	UUFB-0072-P	494.81	537.26

Features

- Includes one painted back and mounting hardware.
- Used to cover wall mount attachment brackets.

To Order, Specify:

- 1) Product number.
- 2) Trim color.

Specification Tips

- For use on Wall Mount Overhead Storage Units only.
- Back must match width of Wall Mounted Overhead Storage Units.

Worksurface Wall Bracket

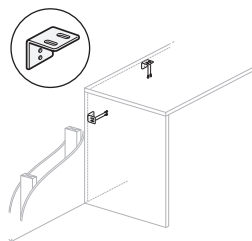

ZUBW-PN

	Number	Price
	ZUBW-0000-PN	\$38.18

Features

- Includes one bracket and worksurface or worksurface support panel mounting screws.
- **Screws/anchors for attachment to wall are field supplied.**
- Worksurface to wall application
 - Partially supports the back of a worksurface in wall mount application when a vertical wall track is not desired.
- Worksurface Support Panel to wall application
 - Attaches a worksurface support panel (ZEFS) to a building wall in a wall mount application when a vertical wall track is not desired.
- Standard in black finish only.

To Order, Specify:

- 1) Product number.
(No finish specification required.)

Specification Tips

- **Must be properly anchored to a structural wall.**
- Worksurface front corners support requirements:
 - One corner must be floor supported.
 - Second corner must be either floor supported or attached to an adjacent worksurface with a flush mount kit.
 - The distance between these floor supports may not exceed 10 feet.

Bracket Requirements

Length of a particular worksurface adjacent to the wall (inches)	Min # of Brackets Required (qty)
12-47	2
48-83	3
84-120	4

Wall Mount Components

	Nominal Height	Width	Number	Fabric Grade					
				A	B	C	E	F	G
Tackboard, Wall Mount	16"(406mm)	24"(610mm)	KUAF-1624	\$343.85	\$361.22	\$363.80	\$388.60	\$469.62	\$498.94
		30"(762mm)	KUAF-1630	361.22	381.48	387.35	419.11	504.98	537.18
		36"(914mm)	KUAF-1636	378.59	401.74	410.90	449.62	540.34	575.42
		42"(1067mm)	KUAF-1642	395.96	422.00	434.45	480.13	575.70	613.66
		48"(1219mm)	KUAF-1648	413.33	442.26	458.00	510.64	611.06	651.90
		60"(1524mm)	KUAF-1660	448.07	482.78	505.10	571.66	681.78	728.38

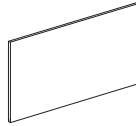

KUAF

Feature

- Includes one tackboard and attachment hardware.

Specification Tip

- Designed to be used under wall mounted overhead storage units.

To Order, Specify:

- Product number.
- Fabric surface and color.

Markerboard, Wall Mount

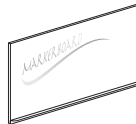

KUAM

	Nominal Height	Width	Number	Price
16"(406mm)	24"(610mm)	KUAM-1624	\$470.36	
	30"(762mm)	KUAM-1630	496.94	
	36"(914mm)	KUAM-1636	523.52	
	42"(1067mm)	KUAM-1642	550.10	
	48"(1219mm)	KUAM-1648	576.68	
	60"(1524mm)	KUAM-1660	629.84	
24"(610mm)	24"(610mm)	KUAM-2424	\$619.37	
	30"(762mm)	KUAM-2430	645.95	
	36"(914mm)	KUAM-2436	672.53	
	42"(1067mm)	KUAM-2442	699.11	
	48"(1219mm)	KUAM-2448	725.69	
	60"(1524mm)	KUAM-2460	778.85	
32"(813mm)	24"(610mm)	KUAM-3224	\$837.80	
	30"(762mm)	KUAM-3230	864.38	
	36"(914mm)	KUAM-3236	890.96	
	42"(1067mm)	KUAM-3242	917.54	
	48"(1219mm)	KUAM-3248	944.12	
	60"(1524mm)	KUAM-3260	997.28	

Features

- Non-magnetic white laminate erasable writing surface with tray.
- Markers and erasers not included.

Specification Tips

- Designed to be used under wall mounted overhead storage units.
- Does not allow task light cord to pass behind.
- The following products are recommended to maintain the markerboard appearance:**
 - Dry erase marker kit (includes holder, six markers and eraser), order part# 7062-8001.
 - Markerboard cleaner and conditioner, order part# 7031-7001.
 - Markerboard spray cleaner, order part# 7031-7002.

To Order, Specify:

- Product number.
(No finish specification required.)

Slat, Wall Mount

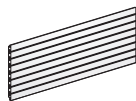

KUPY

	Nominal Height	Width	Number	Trim	
				A	B
16"(406mm)	18"(457mm)	KUPY-1618	\$411.24	\$418.87	
	24"(610mm)	KUPY-1624	445.19	454.71	
	30"(762mm)	KUPY-1630	479.14	490.55	
	36"(914mm)	KUPY-1636	513.09	526.39	
	42"(1067mm)	KUPY-1642	547.04	562.23	
	48"(1219mm)	KUPY-1648	580.99	598.07	
	60"(1524mm)	KUPY-1660	648.89	669.75	

Features

- Includes slat tile & attachment brackets.
- Belong work tools and Jump Stuff slat tile tools may be used.

Specification Tips

- Designed to be used under wall mounted overhead storage units.
- Allows space for task light cord routing.

To Order, Specify:

- Product number.
- Trim color.

Tack Strips/Tackboards

Tack Strip	Height	Thickness	Width	Number	Fabric Grade					
					A	B	C	E	F	G
 HTB	5"(127mm)	1"(25mm)	24"(610mm)	HTB-2405	\$329.77	\$379.11	\$435.03	\$553.48	\$635.72	\$685.05
			30"(762mm)	HTB-3005	343.91	395.36	453.69	577.23	662.99	714.43
			36"(914mm)	HTB-3605	358.05	411.61	472.35	600.98	690.26	743.81
			42"(1067mm)	HTB-4205	372.19	427.86	491.01	624.73	717.53	773.19
			48"(1219mm)	HTB-4805	386.33	444.11	509.67	648.48	744.80	802.57
			54"(1372mm)	HTB-5405	400.47	460.36	528.33	672.23	772.07	831.95
		60"(1524mm)	HTB-6005	414.61	476.61	546.99	695.98	799.34	861.33	

Features

- Includes tack strip and attachment hardware.
- HTB tack strips can be applied to all panel surface types except PLACES monolithic high performance panel.
- Tack strip to be installed on one or more panels of equivalent widths when designated tack area is required or can be mounted to wall track.

To Order, Specify:

- 1) Product number.
- 2) Fabric surface and color.

Tackboard	Height	Thickness	Width	Number	Fabric Grade					
					A	B	C	E	F	G
 HTB	11"(279mm)	1"(25mm)	24"(610mm)	HTB-2411	\$386.23	\$444.21	\$509.79	\$ 648.40	\$ 744.80	\$ 802.47
	16"(406mm)			HTB-2416	433.28	498.46	572.09	727.50	835.70	900.32
	33"(838mm)			HTB-2433	593.25	682.91	783.91	996.44	1144.76	1233.01
	11"(279mm)		30"(762mm)	HTB-3011	\$400.37	\$460.46	\$528.45	\$ 672.15	\$ 772.07	\$ 831.85
	16"(406mm)			HTB-3016	447.42	514.71	590.75	751.25	862.97	929.70
	33"(838mm)			HTB-3033	607.39	699.16	802.57	1020.19	1172.03	1262.39
	11"(279mm)		36"(914mm)	HTB-3611	\$414.51	\$476.71	\$547.11	\$ 695.90	\$ 799.34	\$ 861.23
	16"(406mm)			HTB-3616	461.56	530.96	609.41	775.00	890.24	959.08
	33"(838mm)			HTB-3633	621.53	715.41	821.23	1043.94	1199.30	1291.77
	11"(279mm)		42"(1067mm)	HTB-4211	\$428.65	\$492.96	\$565.77	\$ 719.65	\$ 826.61	\$ 890.61
	16"(406mm)			HTB-4216	475.70	547.21	628.07	798.75	917.51	988.46
	33"(838mm)			HTB-4233	635.67	731.66	839.89	1067.69	1226.57	1321.15
	11"(279mm)		48"(1219mm)	HTB-4811	\$442.79	\$509.21	\$584.43	\$ 743.40	\$ 853.88	\$ 919.99
	16"(406mm)			HTB-4816	489.84	563.46	646.73	822.50	944.78	1017.84
	33"(838mm)			HTB-4833	649.81	747.91	858.55	1091.44	1253.84	1350.53
	11"(279mm)		54"(1372mm)	HTB-5411	\$456.93	\$525.46	\$603.09	\$ 767.15	\$ 881.15	\$ 949.37
	16"(406mm)			HTB-5416	503.98	579.71	665.39	846.25	972.05	1047.22
	33"(838mm)			HTB-5433	663.95	764.16	877.21	1115.19	1281.11	1379.91
	11"(279mm)		60"(1524mm)	HTB-6011	\$471.07	\$541.71	\$621.75	\$ 790.90	\$ 908.42	\$ 978.75
	16"(406mm)			HTB-6016	518.12	595.96	684.05	870.00	999.32	1076.60
33"(838mm)			HTB-6033	678.09	780.41	895.87	1138.94	1308.38	1409.29	

Features

- Includes tackboard and attachment hardware.
- HTB tackboards can be applied to all panel surface types except PLACES monolithic high performance panel.
- Tackboard to be installed on one or more panels of equivalent widths when designated tack area required or can be mounted to wall track.

To Order, Specify:

- 1) Product number.
- 2) Fabric surface and color.

Tack Strips/Tackboards

for use with PLACES Monolithic High Performance Acoustical Panels Only

	Height	Thickness	Width	Number	Fabric Grade					
					A	B	C	E	F	G
Tack Strip — Monolithic High-Performance Acoustical Panels	5"(127mm)	1"(25mm)	24"(610mm)	HTB-2405-H	\$369.82	\$419.16	\$475.08	\$535.53	\$675.77	\$725.10
			30"(762mm)	HTB-3005-H	383.96	435.41	493.74	572.28	703.04	754.48
			36"(914mm)	HTB-3605-H	398.10	451.66	512.40	641.33	730.31	783.86
			42"(1067mm)	HTB-4205-H	412.24	467.91	531.11	671.78	757.58	813.24
			48"(1219mm)	HTB-4805-H	426.38	484.16	549.77	688.53	784.85	842.62
			54"(1372mm)	HTB-5405-H	440.52	500.41	568.33	712.28	812.12	872.00
		60"(1524mm)	HTB-6005-H	454.66	517.16	587.04	736.03	839.39	901.38	

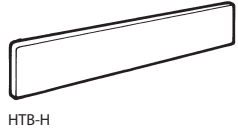

HTB-H

Features

- Includes tack strip and attachment hardware to accommodate monolithic high-performance acoustical panels.
- **HTB-H tack strips are for use with high-performance acoustical panels only.**

To Order, Specify:

- 1) Product number.
- 2) Fabric surface and color.

	Height	Thickness	Width	Number	Fabric Grade					
					A	B	C	E	F	G
Tackboard — Monolithic High-Performance Acoustical Panels	11"(279mm)	1"(25mm)	24"(610mm)	HTB-2411-H	\$476.28	\$484.26	\$549.84	\$688.45	\$784.85	\$842.52
	16"(406mm)			HTB-2416-H	473.33	538.51	612.14	767.55	875.75	940.37
	33"(838mm)			HTB-2433-H	633.30	722.96	823.96	1036.49	1184.81	1273.06
	11"(279mm)		30"(762mm)	HTB-3011-H	\$440.42	\$500.51	\$568.50	\$712.20	\$812.12	\$871.90
	16"(406mm)			HTB-3016-H	487.47	554.76	630.80	791.30	903.02	969.75
	33"(838mm)			HTB-3033-H	647.44	739.21	842.62	1060.24	1212.08	1302.44
	11"(279mm)		36"(914mm)	HTB-3611-H	\$454.56	\$516.76	\$587.16	\$735.95	\$839.39	\$901.28
	16"(406mm)			HTB-3616-H	501.61	571.01	649.46	815.05	930.29	999.13
	33"(838mm)			HTB-3633-H	661.58	755.46	861.28	1083.99	1239.35	1331.82
	11"(279mm)		42"(1067mm)	HTB-4211-H	\$468.70	\$533.01	\$605.82	\$759.70	\$866.66	\$930.66
	16"(406mm)			HTB-4216-H	515.75	587.26	668.12	838.80	957.56	1028.51
	33"(838mm)			HTB-4233-H	675.72	771.71	879.94	1107.74	1266.62	1361.20
	11"(279mm)		48"(1219mm)	HTB-4811-H	\$482.84	\$549.26	\$624.48	\$783.45	\$893.93	\$960.04
	16"(406mm)			HTB-4816-H	529.89	603.51	686.78	862.55	984.83	1057.89
	33"(838mm)			HTB-4833-H	689.86	787.96	898.60	1131.49	1293.89	1390.58
	11"(279mm)		54"(1372mm)	HTB-5411-H	\$496.98	\$565.51	\$643.14	\$807.20	\$921.20	\$989.42
	16"(406mm)			HTB-5416-H	544.03	619.76	705.44	886.30	1012.10	1087.27
	33"(838mm)			HTB-5433-H	704.00	804.21	917.26	1155.24	1321.16	1419.96
	11"(279mm)		60"(1524mm)	HTB-6011-H	\$511.12	\$581.76	\$661.80	\$830.95	\$948.47	\$1018.80
	16"(406mm)			HTB-6016-H	558.17	636.01	724.10	910.05	1039.37	1116.65
33"(838mm)			HTB-6033-H	718.14	820.46	935.92	1178.99	1348.43	1449.34	

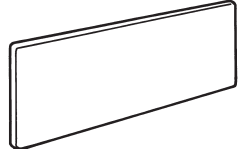

HTB-H

Features

- Includes tackboard and attachment hardware.
- **HTB-H tackboards are for use with high-performance acoustical panels only.**

To Order, Specify:

- 1) Product number.
- 2) Fabric surface and color.

OBSOLETE! March 2024

Markerboards/Wall Accessory Slat Pad

for use with UniGroup Too, UniGroup, PLACES

	Height	Depth	Width	Number	Price
Markerboard — Non-Magnetic Surface	16"(406mm)	3.25"(83mm)	30"(762mm)	MEAM-3016	\$ 519.15
			36"(914mm)	MEAM-3616	545.43
			42"(1067mm)	MEAM-4216	571.71
			48"(1219mm)	MEAM-4816	597.99
	23.125"(587mm)	3.25"(83mm)	60"(1524mm)	MEAM-6016	650.55
			30"(762mm)	HNAM-3023	\$ 679.79
			36"(914mm)	HNAM-3623	724.35
			42"(1067mm)	HNAM-4223	768.91
			48"(1219mm)	HNAM-4823	813.47
			60"(1524mm)	HNAM-6023	902.59
48.125"(1222mm)	3.25"(83mm)	60"(1524mm)	HNAM-6048	\$1187.82	

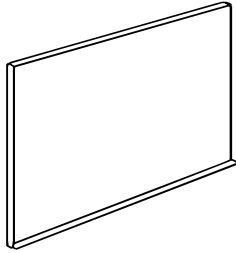

MEAM
Class CA
HNAM
Class BA

Features

- Includes markerboard and tray.
- White erasable writing surface with tray for storage of dry erase markers and eraser.
- Markers and erasers not included.
- Non-magnetic.
- Tray is standard in charcoal and edge is standard in white finish colors.
- May be used on wall track.

Specification Tips

- **The following products are recommended to maintain the markerboard appearance:**
 - Dry erase marker kit (includes holder, six markers and eraser), order part# 7062-8001.
 - Markerboard cleaner and conditioner, order part# 7031-7001.
 - Markerboard spray cleaner, order part# 7031-7002.

To Order, Specify:

- 1) Product number.
(No finish specification required.)

Wall Accessory Slat Pad

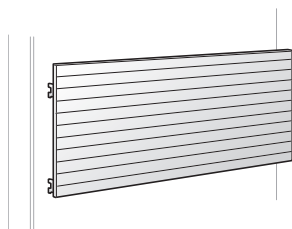

HGRY
Class BA

Height	Width	Number	Trim	
			A	B
16"(406mm)	24"(610mm)	HGRY-2416	\$397.95	\$447.68
	30"(762mm)	HGRY-3016	440.18	489.91
	36"(914mm)	HGRY-3616	482.13	531.86
	42"(1067mm)	HGRY-4216	524.35	574.08
	48"(1219mm)	HGRY-4816	566.30	616.03
	54"(1372mm)	HGRY-5416	608.53	658.26
	60"(1524mm)	HGRY-6016	650.48	700.21

Features

- Includes one pad, end caps and attachment brackets.
- Assembled slat pad thickness is 0.375"(10mm).

To Order, Specify:

- 1) Product number.
- 2) Trim color.

Specification Tips

- Attaches to a UniGroup Too, UniGroup or PLACES panel or a combination of panels that equal the pad width.
- Designed to work with Belong work tools and Jump Stuff slat pad tools.
- Can be mounted under a shelf or overhead storage unit.
- Intended to provide paper management capabilities.
- May be used on wall track.

Markerboard Accessories

	Description	Number	Price
Markerboard Accessories	Dry Erase Marker Kit (holder, six markers and eraser)	7062-8001	\$200.28
	Cleaner and Conditioner	7031-7001	239.12
	Spray Cleaner	7031-7002	72.99

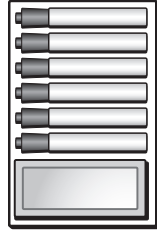

7062-8001



7031-7002



7031-7001

Class YA

Feature

- Recommended dry erase marker products to maintain, clean & condition markerboards.

To Order, Specify:

- 1) Product number
(No finish specification required.)

Belong Work Tools Mounting Rails

for use with Adaptable Worksurfaces

Tool Rail — Worksurface Mount C-Clamp or Thru-Mount

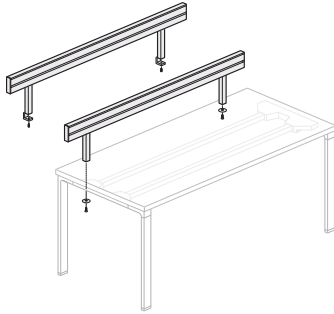

KUR1-1224-CSN

Rail Height	Width	Description	Number	Price	
				A	B
1.19" (30mm) Thick Top					
4" (102mm)	24" (610mm)	C-Clamp	KUR1-1224-CSN	\$445.87	\$465.88
	30" (762mm)		KUR1-1230-CSN	469.54	491.37
	36" (914mm)		KUR1-1236-CSN	493.21	516.86
	42" (1067mm)		KUR1-1242-CSN	516.88	542.35
	48" (1219mm)		KUR1-1248-CSN	540.55	567.84
	54" (1372mm)		KUR1-1254-CSN	564.22	593.33
60" (1524mm)		KUR1-1260-CSN	709.83	740.76	
2" (51mm) thick Top					
4" (102mm)	24" (610mm)	C-Clamp	KUR1-1224-CMN	\$445.87	\$465.88
	30" (762mm)		KUR1-1230-CMN	469.54	491.37
	36" (914mm)		KUR1-1236-CMN	493.21	516.86
	42" (1067mm)		KUR1-1242-CMN	516.88	542.35
	48" (1219mm)		KUR1-1248-CMN	540.55	567.84
	54" (1372mm)		KUR1-1254-CMN	564.22	593.33
60" (1524mm)		KUR1-1260-CMN	709.83	740.76	
1.19" (30mm) Thick Top					
4" (102mm)	24" (610mm)	Thru-mount	KUR1-1224-TSN	\$445.87	\$465.88
	30" (762mm)		KUR1-1230-TSN	469.54	491.37
	36" (914mm)		KUR1-1236-TSN	493.21	516.86
	42" (1067mm)		KUR1-1242-TSN	516.88	542.35
	48" (1219mm)		KUR1-1248-TSN	540.55	567.84
	54" (1372mm)		KUR1-1254-TSN	564.22	593.33
60" (1524mm)		KUR1-1260-TSN	709.83	740.76	
2" (51mm) thick Top					
4" (102mm)	24" (610mm)	Thru-mount	KUR1-1224-TMN	\$445.87	\$465.88
	30" (762mm)		KUR1-1230-TMN	469.54	491.37
	36" (914mm)		KUR1-1236-TMN	493.21	516.86
	42" (1067mm)		KUR1-1242-TMN	516.88	542.35
	48" (1219mm)		KUR1-1248-TMN	540.55	567.84
	54" (1372mm)		KUR1-1254-TMN	564.22	593.33
60" (1524mm)		KUR1-1260-TMN	709.83	740.76	

Features

- Includes one double sided rail with two posts, two rail end caps and attachment hardware.
- Mounts to worksurface to support rail tools.
- 1.19" (30mm) C-clamp Rail mounts on worksurfaces from 0.75" (19mm) to 1.75" (44mm) thick.
- Thru-mount Rail mounts on 1.19" (30mm) thick worksurfaces.
- Posts are 1.25" (32mm) thick.
- Belong Rail tools separately specified.
- Belong Work Tools or JumpStuff Slat Pad Tools may be used; separately specified.
- Rail overall height above worksurface: 11.81" (300mm).
- Distance between rail bottom and top of worksurface: 7.44" (189mm).
- Ships unassembled.

Specification Tips

- Designed for single sided Reside desking and single sided benching applications.
- **Not designed to be used in front of panel mounted accessories (tackboard, markerboard).**
- Rail holds up to a maximum of 40 pounds (18.14kg) evenly distributed on one side.
- Rail may be installed off modular.
- Heavy load application; additional posts can be ordered.
- Monitor arm cannot be mounted in post positions.
- Thru-mount post can be attached flush to back edge of worksurface.
- C-clamp rail can be attached to panel mounted worksurface with notch or radius wireways without removing the worksurface.
- Under worksurface: 4" (102mm) of clearance is necessary between back of worksurface and adjacent component for clamp attachment.
- Gap between screen and horizontal surface allows installation of Belong Tool Rail.
- Utility tray provides clearance for installation of Belong Tool Rail.
- Refer to Specification Guide for planning rules.

Note: No more than 6" (152mm) of rail can be extended beyond outside of support.

To Order, Specify:

- 1) Product number.
- 2) Trim color for rail/post.
- 3) Trim color for rail end caps:
 - TR-K Charcoal
 - TR-J Graphite
 - TR-FM Snow

Belong Work Tools Mounting Rails

for use with Adaptable Worksurfaces

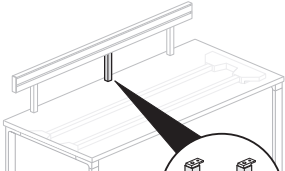
	Post Height	Description	Number	Price	
				A	B
Tool Rail — Single Post — C-Clamp or Thru-mount 	1.19"(30mm) Thick Top				
	7.5"(191mm)	C-Clamp	KUP1-0000-CSN	\$138.29	\$149.21
	2"(51mm) Thick Top				
	7.5"(191mm)	C-Clamp	KUP1-0000-CMN	\$138.29	\$149.21
	1.19"(30mm) Thick Top				
	7.5"(191mm)	Thru-mount	KUP1-0000-TSN	\$138.29	\$149.21
	2"(51mm) Thick Top				
	7.5"(191mm)	Thru-mount	KUP1-0000-TMN	\$138.29	\$149.21

KUP1-0000-CSN

Features

- Includes one C-clamp or one Thru-mount Post and attachment hardware.
- Posts mount on worksurfaces 1.81"(46mm)-2"(51mm) thick.
- Posts are 1.25"(32mm) thick.



To Order, Specify:



- 1) Product number.
- 2) Trim color.

Specification Tips

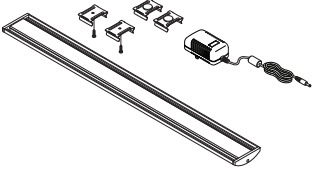
- Posts supports slide along rail bottom groove.
- For use with C-clamp or Thru-mount tool rail only.
- Monitor arm cannot be mounted in post position.
- Extra single posts can be ordered when additional support for monitor arms and paper management are attached to Tool Rail.
- Refer to Specification Guide for planning rules.

Lighting — Task

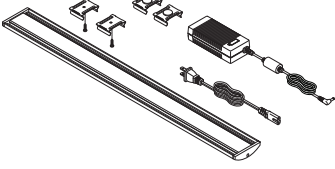
	Fixture Length	Watts	Number	Price
Reed Premier™ Stand-Alone LED Task Light  LUTS-0017-19ULD5 	16.4"(417mm)	7.8	LUTS-0017-19ULD5	\$366.83
	Features <ul style="list-style-type: none"> • Includes 17"(432mm) LED fixture, 15 watt power supply with nine foot removable power cord. • Standard in anodized (silver) color with white end caps. • Height: 0.5"(12.7mm); Width: 2.0"(51mm); Length: 16.4"(417mm). 			
Specification Tips <ul style="list-style-type: none"> • For use with 120 volt, 60 hertz electrical system. • Color Temp: 3500K. • Color Rendition Index: 84 CRI. • Rated Lifespan: 5 0,000 hour. • Not intended for daisy chaining. • Single touch on/off with continuous dimming from 15-100%. • Includes screw and magnetic attachment hardware for steel, laminate and wood. • Intended for use in horizontal applications. 				
To Order, Specify: <ol style="list-style-type: none"> 1) Product number. (No finish specification required.) 				

Reed Premier™ Starter LED Task Light  LUTS-0017-12ULD6 	16.4"(417mm)	7.8	LUTS-0017-12ULD6	\$ 504.40
	30.1"(765mm)	17.6	LUTS-0031-12ULD6	734.00
	43.7"(1110mm)	25.9	LUTS-0044-12ULD6	947.20
	57.4"(1458mm)	33.6	LUTS-0058-12ULD6	1176.80
	Features <ul style="list-style-type: none"> • Includes LED fixture, 60 watt power supply with twelve foot removable power cord. • Standard in anodized (silver) color with white end caps. • Height: 0.5"(12.7mm); Width: 2.0"(51mm); Lengths: 16.4"(417mm), 30.1"(765mm), 43.7"(1110mm) or 57.4"(1458mm). 			
Specification Tips <ul style="list-style-type: none"> • For use with 120 volt, 60 hertz electrical system. • Color Temp: 3500K. • Color Rendition Index: 84 CRI. • Rated Lifespan: 5 0,000 hour. • Refer to the Specification Guide for a chart showing the total number of light fixtures that can be daisy chained together. • Single touch on/off with continuous dimming from 15-100%. • Includes screw and magnetic attachment hardware for steel, laminate and wood. • Intended for use in horizontal applications. 				
To Order, Specify: <ol style="list-style-type: none"> 1) Product number. (No finish specification required.) 				

Lighting — Task

	Fixture Length	Watts	Number	Price
Reed Premier™	16.4"(417mm)	7.8	LUTD-0017-1NULDN	\$ 366.83
Add-On LED Task Light —	30.1"(765mm)	17.6	LUTD-0031-1NULDN	596.43
For Use with Reed Premier Starter	43.7"(1110mm)	25.9	LUTD-0044-1NULDN	809.63
LED Task Lights	57.4"(1458mm)	33.6	LUTD-0058-1NULDN	1039.23

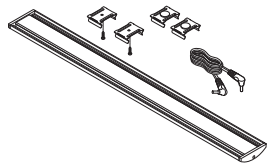

LUTD-0017-1NULDN



Features

- Includes LED fixture, 8"(203mm) and 30"(762mm) daisy chain cord.
- Standard in anodized (silver) color with white end caps.
- Height: 0.5"(12.7mm); Width: 2.0"(51mm); Lengths: 16.4"(417mm), 30.1"(765mm), 43.7"(1110mm) or 57.4"(1458mm).

To Order, Specify:

- 1) Product number.
(No finish specification required.)

Specification Tips

- For use with 120 volt, 60 hertz electrical system.
- Color Temp: 3500K.
- Color Rendition Index: 84 CRI.
- Rated Lifespan: 5 0,000 hour.
- Refer to the Specification Guide for a chart showing the total number of light fixtures that can be daisy chained together.
- Single touch on/off with continuous dimming from 15-100%.
- Includes screw and magnetic attachment hardware for steel, laminate and wood.
- Intended for use in horizontal applications.

Reed Premier™ Add-On Occupancy Sensor

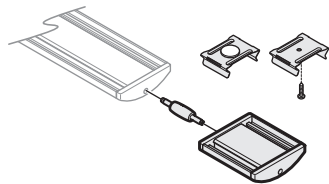

LUTS-0000



LUTS-0000

\$412.73

Features

- Includes occupancy sensor and attachment connector.
- Standard in anodized (silver) color with white end caps.
- Height: 0.7"(17.8mm); Width: 2.0"(51mm); Length: 2.3"(58mm).

To Order, Specify:

- 1) Product number.
(No finish specification required.)

Specification Tips

- For use with 120 volt, 60 hertz electrical system.
- Includes screw and magnetic attachment hardware for steel, laminate and wood.
- Intended for use in horizontal applications.

Lighting — Haworth

	Fixture Length	Total Length with Switch	Watts	Number	Price
Adaptable LED Task Light - Stand-Alone	17"(432mm)	18.6"(472mm)	5.6	LUTN-0017-19ULDN	\$244.53
	31"(787mm)	32.6"(828mm)	10.3	LUTN-0031-19ULDN	277.57
	44"(1118mm)	45.6"(1158mm)	14.3	LUTN-0044-19ULDN	308.25

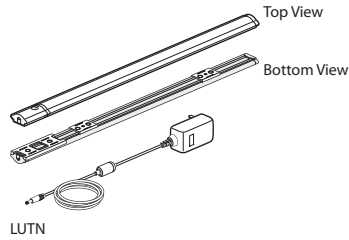

LUTN



Features

- Includes 17"(1118mm), 31"(787mm) or 44"(1118mm) LED fixture, one on/off/dimmer pack, 18 watt power supply with black nine foot power cord, two adhesive cord managers and screw/magnetic attachment hardware.
- Standard in anodized (silver) color with black caps.
- Height: 0.5"(12.7mm); Width: 1.18"(30mm).
- Automatic turn off after 12 hours (+/- 15 mins).

To Order, Specify:

- 1) Product number.
(No finish specification required.)

Specification Tips

- For use with 120 volt, 60 hertz electrical system.
- Color Temp: 3500K.
- Color Rendition Index: 85 CRI.
- Rated Lifespan: 52,000 hour.
- **Not intended for daisy chaining.**
- Single touch on/off with continuous dimming from 15-100% with last state memory.
- Intended for use under shelf or cabinet.

Adaptable LED Task Light - Starter Kit	17"(432mm)	18.6"(472mm)	5.6	LUTT-0017-11ULDN	\$277.41
	31"(787mm)	32.6"(828mm)	10.3	LUTT-0031-11ULDN	310.45
	44"(1118mm)	45.6"(1158mm)	14.3	LUTT-0044-11ULDN	341.13

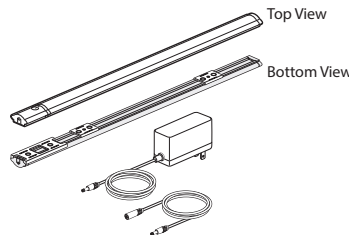

LUTT



Features

- Includes LED fixture, one on/off/dimmer pack, 65 watt power supply with eleven foot power cord, two adhesive cord managers, and screw/magnetic attachment hardware.
- Standard in anodized (silver) color with black caps.
- Height: 0.5"(12.7mm); Width: 1.18"(30mm).
- Automatic turn off after 12 hours (+/- 15 mins).

To Order, Specify:

- 1) Product number.
(No finish specification required.)

Specification Tips

- For use with 120 volt, 60 hertz electrical system.
- Color Temp: 3500K.
- Color Rendition Index: 85 CRI.
- Rated Lifespan: 52,000 hour.
- Refer to the Specification Guide or under the Adaptable LED Task Light - Add-on Kit for a chart showing the total number of light fixtures that can be daisy chained together.
- Single touch on/off with continuous dimming from 15-100% with last state memory.
- The on/off dimmer switch on the Starter Kit fixture will control all connected Add-On lights.
- Intended for use under shelf or cabinet.

Lighting — Haworth

	Fixture Length	Watts	Number	Price
Adaptable LED Task Light - Add-On Kit	17"(432mm)	5.6	LUTA-0017-1NULDN	\$205.92
	31"(787mm)	10.3	LUTA-0031-1NULDN	238.96
	44"(1118mm)	14.3	LUTA-0044-1NULDN	269.64

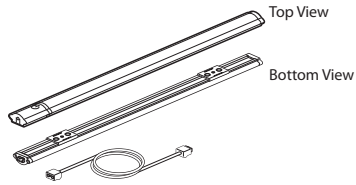

LUTA



Features

- Includes LED fixture, 18"(457mm) daisy chain cord, two adhesive cord mangers, and screw/magnetic attachment hardware.
- Standard in anodized (silver) color with black caps.
- Height: 0.5"(12.7mm); Width: 1.18"(30mm).

To Order, Specify:

- 1) Product number.
(No finish specification required.)

Specification Tips

- For use with 120 volt, 60 hertz electrical system.
- Color Temp: 3500K.
- Color Rendition Index: 85 CRI.
- Rated Lifespan: 52,000 hour.
- Refer to the chart below for the total number of light fixtures that can be daisy chained together.
- The on/off dimmer switch on the Starter Kit fixture will control all connected Add-On lights.
- Intended for use under shelf or cabinet.

Daisy Chair Combinations	# of 17" Lights	# of 31" Lights	# of 44" Lights
Combination 1	1	1	1
Combination 2	1	1	0
Combination 3	1	2	0
Combination 4	1	0	1
Combination 5	1	0	0
Combination 6	2	1	0
Combination 7	2	0	1
Combination 8	2	0	0
Combination 9	3	1	0
Combination 10	3	0	0
Combination 11	4	0	0
Combination 12	0	1	1
Combination 14	0	2	0
Combination 15	0	3	0
Combination 17	0	0	2

Finish/Color Legend

Wood Finishes

Grade A

Double Cut

2P-RL	Applegate
WE-RD	Dune
WJ-RE	Ebony ⁽¹⁾
2N-RL	Echo
W3-HR	Harbor
WE-RT	Melba ⁽¹⁾
W4-PB	Pebble

Grade B

Anegre Quarter Cut
NP-W08 Golden

Cherry

VC-CA1	Amber
VC-W23	American
VC-W33	Caramel
VC-W30	Heritage
VC-W32	Pacific

Maple

VP-LM	Light
VP-N	Natural ⁽²⁾

Maple Quarter Cut

NM-N	Natural
------	---------

Rift Cut White Oak

NR-W35	Clear
NR-W15	Espresso
NR-W40	Mocha

Walnut

VR-W15	Espresso
VR-W21	Mahogany Satin
VR-W31	Retro

Walnut Quarter Cut

NW-W35	Clear
NW-W15	Espresso
NW-W31	Retro

Laminate

Grade A

Solid Color

H-34	Beige
H-AK	Chalk
H-8J	Charcoal
H-3J	Graphite
H-62	Gray Tone
H-WL	Linen
H-3P	Platinum
H-AA	Putty
H-3E	Smoke

Patterned

H-P1	Linen Casual
H-P2	Linen Classic
H-P3	Linen Crisp
H-P4	Linen Flax

Wood

H-AE	Maple
------	-------

Grade B

Premium Wood Grain

H-KA	Brazilwood
H-KG	Columbian Walnut
H-KP	Field Elm
H-KN	Grey Elm
H-KM	Landmark Wood
H-KL	Neo Walnut
H-KC	New Age Oak
H-KR	Phantom Ecru
H-KS	Phantom Pearl
H-KD	River Cherry
H-KE	Sanara
H-KF	Williamsburg Cherry

Grade E

Premium

H-C1	Hay
H-C2	Drift
H-C3	Pecan
H-C4	Molasses
H-C5	Mineral
H-C6	Hatch
H-C7	Tanned

Edgeband

Solid Color

HP-34	Beige
HP-AK	Chalk
HP-8J	Charcoal
HP-3J	Graphite
HP-62	Gray Tone
HP-WL	Linen
HP-3P	Platinum
HP-AA	Putty
HP-3E	Smoke

Patterned Edgeband

HP-P1	Linen Casual
HP-P2	Linen Classic
HP-P3	Linen Crisp
HP-P4	Linen Flax

Wood Grain

HP-KA	Brazilwood
HP-AM	Cherry
HP-KG	Columbian Walnut
HP-KP	Field Elm
HP-KN	Grey Elm
HP-KM	Landmark Wood
HP-AE	Maple
HP-AD	Medium Cherry
HP-KL	Neo Walnut
HP-KC	New Age Oak
HP-KR	Phantom Ecru
HP-KS	Phantom Pearl
HP-KD	River Cherry
HP-KE	Sanara
HP-KF	Williamsburg Cherry

Ply-Edge

HP-PW	Ply-Edge
-------	----------

Premium

HP-C1	Hay
HP-C2	Drift
HP-C3	Pecan
HP-C4	Molasses
HP-C5	Mineral
HP-C6	Hatch
HP-C7	Tanned

Trim - UniGroup and PLACES

Grade A

TR-R	Beige
TR-AK	Chalk
TR-K	Charcoal
TR-J	Graphite
TR-G	Gray Tone
TR-AA	Putty
TR-E	Smoke

Trim - UniGroup Too

Grade A

TR-R	Beige
TR-AK	Chalk
TR-K	Charcoal
TR-J	Graphite
TR-G	Gray Tone
TR-AA	Putty
TR-E	Smoke

Grade B

TR-MC	Metallic Champagne
TR-LE	Metallic Silver

Glass - Solid

Grade A

SK-1C	Clear
-------	-------

Glass - Patterned⁽³⁾

Grade C

SQ-ER	English Reeded
-------	----------------

Grade D

SQ-CM	Checks Mix
SQ-VM	Vertical Moire

Lock Plugs

LR-BL	Black
LR-BP	Chrome

ALERT: These materials are current, however they are being considered for future obsolescence due to low volume.

Wood:

2R-RL	Butternut
NP-W08	Golden
NP-W07	Light
NX-U	Medium
VR-W12	Naturally Walnut
VP-AD	Sand
WC-RW	Wenge

Laminate:

H-AM	Amber Cherry
H-AD	Medium Cherry

Forest Stewardship Council®

(FSC®) Statement: In our continuing support of sustainable forestry and responsible purchasing, Haworth North America is offering FSC certified wood products at no up-charge. By providing FSC certified material, Haworth is supporting our client's green building goals and demonstrating our collective commitment to source materials more sustainably.

Haworth will provide to you the necessary FSC-certified paperwork with your shipment. For more information, FAQs, and a complete FSC product list (including product exceptions), go to the Library and search FSC.

Haworth FSC Trademark License
#FSC-C002821

⁽¹⁾Available on Adaptable Components only.

⁽²⁾Not available on UniGroup Panels.

⁽³⁾Available on Add-on Panels only.

Fabrics/Color Legend

Vertical Fabrics

Grade A

Chevron (6X)
Highlands (L6)
Striae (C1)
Tailored (PY)
Tellure (3A)

Grade B

Classic (L5)
Fields (34)
Hue (6)
Shimmer (WS)

Grade C

Birds Nest (PH)
Sisal (SW)
Thorman (45)

Grade D

Tangram (LV)

Haworth+

For information on the Haworth+ alliance program, including images and product availability, please refer to:
[Haworth.com](https://www.haworth.com) > Surface Collection > Haworth+ Library

Customer's Own Material (COM)

For general Customer's Own Material (COM) information including processes and forms, please refer to:
[Haworth.com](https://www.haworth.com) > Surface Collection > Resources > COM
For information on approved COM's, please refer to:
[Haworth.com](https://www.haworth.com) > Surface Collection > COM Library

* For most current finish and fabric availability please reference surfaces.haworth.com.

COM Yardage Requirements

Actual (Inches) Height	Width	54 Inch Roll (Linear Yards)			66 Inch Roll (Linear Yards)		
		Directional Rightway	Directional Railroad	Non- directional	Directional Rightway	Directional Railroad	Non- directional
Straight Panel							
32"(813mm)	24" (610mm)	0.42	0.78	0.42	0.42	0.39	0.39
	30" (762mm)	0.83	0.94	0.83	0.42	0.47	0.42
	36" (914mm)	0.83	1.11	0.83	0.83	0.56	0.56
	42" (1067mm)	0.83	1.28	0.83	0.83	0.64	0.64
	48" (1219mm)	0.83	1.44	0.83	0.83	0.72	0.72
	60" (1529mm)	N/A	1.78	1.78	0.83	0.89	0.83
40"(1016mm)	24" (610mm)	0.51	0.78	0.51	0.51	0.78	0.51
	30" (762mm)	1.03	0.94	0.94	0.51	0.94	0.51
	36" (914mm)	1.03	1.11	1.03	1.03	1.11	1.03
	42" (1067mm)	1.03	1.28	1.03	1.03	1.28	1.03
	48" (1219mm)	1.03	1.44	1.03	1.03	1.44	1.03
	60" (1529mm)	N/A	1.78	1.78	1.03	1.78	1.03
48"(1219mm)	24" (610mm)	0.61	0.78	0.61	0.61	0.78	0.61
	30" (762mm)	1.22	0.94	0.94	0.61	0.94	0.61
	36" (914mm)	1.22	1.11	1.11	1.22	1.11	1.11
	42" (1067mm)	1.22	1.28	1.22	1.22	1.28	1.22
	48" (1219mm)	1.22	1.44	1.22	1.22	1.44	1.22
	60" (1529mm)	N/A	1.78	1.78	1.22	1.78	1.22
56"(1422mm)	24" (610mm)	0.78	0.78	0.78	0.78	0.78	0.78
	30" (762mm)	1.56	0.94	0.94	0.78	0.94	0.78
	36" (914mm)	1.56	1.11	1.11	1.56	1.11	1.11
	42" (1067mm)	1.56	1.28	1.28	1.56	1.28	1.28
	48" (1219mm)	1.56	1.44	1.44	1.56	1.44	1.44
	60" (1529mm)	N/A	1.78	1.78	1.56	1.78	1.56
64"(1626mm)	24" (610mm)	0.89	N/A	0.89	0.89	0.78	0.78
	30" (762mm)	1.78	N/A	1.78	0.89	0.94	0.89
	36" (914mm)	1.78	N/A	1.78	1.78	1.11	1.11
	42" (1067mm)	1.78	N/A	1.78	1.78	1.28	1.28
	48" (1219mm)	1.78	N/A	1.78	1.78	1.44	1.44
	60" (1529mm)	N/A	N/A	N/A	1.78	1.78	1.78
72"(1829mm)	24" (610mm)	0.94	N/A	0.94	0.94	0.78	0.78
	30" (762mm)	1.89	N/A	1.89	0.94	0.94	0.94
	36" (914mm)	1.89	N/A	1.89	1.89	1.11	1.11
	42" (1067mm)	1.89	N/A	1.89	1.89	1.28	1.28
	48" (1219mm)	1.89	N/A	1.89	1.89	1.44	1.44
	60" (1529mm)	N/A	N/A	N/A	1.89	1.78	1.78
80"(2032mm)	24" (610mm)	1.14	N/A	1.14	1.14	N/A	1.14
	30" (762mm)	2.28	N/A	2.28	1.14	N/A	1.14
	36" (914mm)	2.28	N/A	2.28	2.28	N/A	2.28
	42" (1067mm)	2.28	N/A	2.28	2.28	N/A	2.28
	48" (1219mm)	2.28	N/A	2.28	2.28	N/A	2.28
	60" (1529mm)	N/A	N/A	N/A	2.28	N/A	2.28

COM Yardage Requirements

UniGroup Too

Actual (Inches) Height	Width	54 Inch Roll (Linear Yards)			66 Inch Roll (Linear Yards)		
		Directional Rightway	Directional Railroad	Non- directional	Directional Rightway	Directional Railroad	Non- directional
Finish Posts							
32"(813mm)		0.10	0.10	0.10	0.08	0.10	0.08
40"(1016mm)		0.13	0.19	0.13	0.10	0.10	0.10
48"(1219mm)		0.16	0.19	0.16	0.12	0.19	0.12
56"(1422mm)		0.21	0.19	0.19	0.16	0.19	0.15
64"(1626mm)		0.24	N/A	0.24	0.19	0.19	0.19
72"(1829mm)		0.25	N/A	0.25	0.20	0.19	0.19
80"(2032mm)		0.31	N/A	0.31	0.24	N/A	0.24

Actual (Inches) Height	Width	54 Inch Roll (Linear Yards)			66 Inch Roll (Linear Yards)		
		Directional Rightway	Directional Railroad	Non- directional	Directional Rightway	Directional Railroad	Non- directional
Tackboard and Tack Strip							
5" (127mm)	24" (610mm)	0.31	0.21	0.21	0.31	0.14	0.14
	30" (762mm)	0.31	0.25	0.25	0.31	0.17	0.17
	36" (914mm)	0.31	0.29	0.29	0.31	0.19	0.19
	42" (1067mm)	0.31	0.33	0.31	0.31	0.22	0.22
	48" (1219mm)	0.31	0.38	0.31	0.31	0.25	0.25
	60" (1529mm)	N/A	0.46	0.46	0.31	0.31	0.31
11" (279mm)	24" (610mm)	0.47	0.42	0.42	0.47	0.28	0.28
	30" (762mm)	0.47	0.50	0.47	0.47	0.33	0.33
	36" (914mm)	0.47	0.58	0.47	0.47	0.39	0.39
	42" (1067mm)	0.47	0.67	0.47	0.47	0.44	0.44
	48" (1219mm)	0.47	0.75	0.47	0.47	0.50	0.47
	54" (1371mm)	N/A	0.83	0.83	0.47	0.56	0.47
16" (406mm)	24" (610mm)	0.61	0.42	0.42	0.61	0.28	0.28
	30" (762mm)	0.61	0.50	0.50	0.61	0.33	0.33
	36" (914mm)	0.61	0.58	0.58	0.61	0.39	0.39
	42" (1067mm)	0.61	0.67	0.61	0.61	0.44	0.44
	48" (1219mm)	0.61	0.75	0.61	0.61	0.50	0.50
	54" (1371mm)	N/A	0.83	0.83	0.61	0.56	0.56
33" (838mm)	24" (610mm)	1.08	0.83	0.83	1.08	0.83	0.83
	30" (762mm)	1.08	1.00	1.00	1.08	1.00	1.00
	36" (914mm)	1.08	1.17	1.08	1.08	1.17	1.08
	42" (1067mm)	1.08	1.33	1.08	1.08	1.33	1.08
	48" (1219mm)	1.08	1.50	1.08	1.08	1.50	1.08
	54" (1371mm)	N/A	1.67	1.67	1.08	1.67	1.08
	60" (1529mm)	N/A	1.83	1.83	1.08	1.83	1.08

COM Yardage Requirements

UniGroup

Actual (Inches) Height	Width	54 Inch Roll (Linear Yards)			66 Inch Roll (Linear Yards)		
		Directional Rightway	Directional Railroad	Non- directional	Directional Rightway	Directional Railroad	Non- directional
Straight Panel							
30" (762mm)	12" (305mm)	0.28	0.44	0.28	0.21	0.22	0.21
	18" (457mm)	0.42	0.61	0.42	0.28	0.31	0.28
	24" (610mm)	0.42	0.78	0.42	0.42	0.39	0.39
	30" (762mm)	0.83	0.94	0.83	0.42	0.47	0.42
	36" (914mm)	0.83	1.11	0.83	0.83	0.56	0.56
	42" (1067mm)	0.83	1.28	0.83	0.83	0.64	0.64
	48" (1219mm)	0.83	1.44	0.83	0.83	0.72	0.72
	54" (1371mm)	N/A	1.61	1.61	0.83	0.81	0.81
	60" (1529mm)	N/A	1.78	1.78	0.83	0.89	0.83
37" (940mm)	12" (305mm)	0.34	0.44	0.34	0.26	0.44	0.26
	18" (457mm)	0.51	0.61	0.51	0.34	0.61	0.34
	24" (610mm)	0.51	0.78	0.51	0.51	0.78	0.51
	30" (762mm)	1.03	0.94	0.94	0.51	0.94	0.51
	36" (914mm)	1.03	1.11	1.03	1.03	1.11	1.03
	42" (1067mm)	1.03	1.28	1.03	1.03	1.28	1.03
	48" (1219mm)	1.03	1.44	1.03	1.03	1.44	1.03
	54" (1371mm)	N/A	1.61	1.61	1.03	1.61	1.03
	60" (1529mm)	N/A	1.78	1.78	1.03	1.78	1.03
44" (1118mm)	12" (305mm)	0.41	0.44	0.41	0.31	0.44	0.31
	18" (457mm)	0.61	0.61	0.61	0.41	0.61	0.41
	24" (610mm)	0.61	0.78	0.61	0.61	0.78	0.61
	30" (762mm)	1.22	0.94	0.94	0.61	0.94	0.61
	36" (914mm)	1.22	1.11	1.11	1.22	1.11	1.11
	42" (1067mm)	1.22	1.28	1.22	1.22	1.28	1.22
	48" (1219mm)	1.22	1.44	1.22	1.22	1.44	1.22
	54" (1371mm)	N/A	1.61	1.61	1.22	1.61	1.22
	60" (1529mm)	N/A	1.78	1.78	1.22	1.78	1.22
50" (1270mm)	12" (305mm)	0.46	0.44	0.44	0.35	0.44	0.35
	18" (457mm)	0.69	0.61	0.61	0.46	0.61	0.46
	24" (610mm)	0.69	0.78	0.69	0.69	0.78	0.69
	30" (762mm)	1.39	0.94	0.94	0.69	0.94	0.69
	36" (914mm)	1.39	1.11	1.11	1.39	1.11	1.11
	42" (1067mm)	1.39	1.28	1.28	1.39	1.28	1.28
	48" (1219mm)	1.39	1.44	1.39	1.39	1.44	1.39
	54" (1371mm)	N/A	1.61	1.61	1.39	1.61	1.39
	60" (1529mm)	N/A	1.78	1.78	1.39	1.78	1.39
64" (1626mm)	12" (305mm)	0.59	N/A	0.59	0.44	0.44	0.44
	18" (457mm)	0.89	N/A	0.89	0.59	0.61	0.59
	24" (610mm)	0.89	N/A	0.89	0.89	0.78	0.78
	30" (762mm)	1.78	N/A	1.78	0.89	0.94	0.89
	36" (914mm)	1.78	N/A	1.78	1.78	1.11	1.11
	42" (1067mm)	1.78	N/A	1.78	1.78	1.28	1.28
	48" (1219mm)	1.78	N/A	1.78	1.78	1.44	1.44
	54" (1371mm)	N/A	N/A	N/A	1.78	1.61	1.61
	60" (1529mm)	N/A	N/A	N/A	1.78	1.78	1.78
68" (1727mm)	12" (305mm)	0.63	N/A	0.63	0.47	0.44	0.44
	18" (457mm)	0.94	N/A	0.94	0.63	0.61	0.61
	24" (610mm)	0.94	N/A	0.94	0.94	0.78	0.78
	30" (762mm)	1.89	N/A	1.89	0.94	0.94	0.94
	36" (914mm)	1.89	N/A	1.89	1.89	1.11	1.11
	42" (1067mm)	1.89	N/A	1.89	1.89	1.28	1.28
	48" (1219mm)	1.89	N/A	1.89	1.89	1.44	1.44
	54" (1371mm)	N/A	N/A	N/A	1.89	1.61	1.61
	60" (1529mm)	N/A	N/A	N/A	1.89	1.78	1.78

COM Yardage Requirements

UniGroup

Actual (Inches) Height	Width	54 Inch Roll (Linear Yards)			66 Inch Roll (Linear Yards)		
		Directional Rightway	Directional Railroad	Non- directional	Directional Rightway	Directional Railroad	Non- directional
Straight Panel							
82" (2083mm)	12" (305mm)	0.76	N/A	0.76	0.57	N/A	0.57
	18" (457mm)	1.14	N/A	1.14	0.76	N/A	0.76
	24" (610mm)	1.14	N/A	1.14	1.14	N/A	1.14
	30" (762mm)	2.28	N/A	2.28	1.14	N/A	1.14
	36" (914mm)	2.28	N/A	2.28	2.28	N/A	2.28
	42" (1067mm)	2.28	N/A	2.28	2.28	N/A	2.28
	48" (1219mm)	2.28	N/A	2.28	2.28	N/A	2.28
	54" (1371mm)	N/A	N/A	N/A	2.28	N/A	2.28
	60" (1529mm)	N/A	N/A	N/A	2.28	N/A	2.28

Actual (Inches) Height - Side Rail	Width	54 Inch Roll (Linear Yards)			66 Inch Roll (Linear Yards)		
		Directional Rightway	Directional Railroad	Non- directional	Directional Rightway	Directional Railroad	Non- directional
Add-On Panel							
12" (305mm)	12" (305mm)	0.15	0.15	0.15	0.11	0.11	0.11
	18" (459mm)	0.22	0.20	0.20	0.15	0.15	0.15
	24" (610mm)	0.25	0.26	0.25	0.25	0.26	0.25
	30" (762mm)	0.50	0.32	0.32	0.25	0.32	0.25
	36" (914mm)	0.50	0.37	0.37	0.50	0.37	0.37
	42" (1067mm)	0.50	0.43	0.43	0.45	0.40	0.40
	48" (1219mm)	0.50	0.48	0.48	0.50	0.48	0.48
	54" (1372mm)	N/A	0.54	0.54	0.45	0.40	0.40
	60" (1529mm)	N/A	0.59	0.59	0.50	0.59	0.50
14" (356mm)	12" (305mm)	0.17	0.15	0.15	0.13	0.15	0.13
	18" (459mm)	0.25	0.20	0.20	0.17	0.20	0.17
	24" (610mm)	0.25	0.26	0.25	0.25	0.26	0.25
	30" (762mm)	0.50	0.31	0.31	0.25	0.31	0.25
	36" (914mm)	0.50	0.37	0.37	0.50	0.37	0.37
	42" (1067mm)	0.50	0.43	0.43	0.50	0.43	0.43
	48" (1219mm)	0.50	0.48	0.48	0.50	0.48	0.49
	54" (1372mm)	N/A	0.54	0.54	0.50	0.54	0.50
	60" (1529mm)	N/A	0.59	0.59	0.50	0.59	0.50
18" (457mm)	12" (305mm)	0.20	0.22	0.20	0.15	0.15	0.15
	18" (457mm)	0.31	0.31	0.31	0.20	0.20	0.20
	24" (610mm)	0.31	0.39	0.31	0.31	0.26	0.26
	30" (762mm)	0.61	0.47	0.47	0.31	0.31	0.31
	36" (914mm)	0.61	0.56	0.56	0.61	0.37	0.37
	42" (1067mm)	0.61	0.64	0.61	0.61	0.43	0.43
	48" (1219mm)	0.61	0.72	0.61	0.61	0.48	0.48
	54" (1372mm)	N/A	0.81	0.81	0.61	0.54	0.54
	60" (1529mm)	N/A	0.89	0.89	0.61	0.59	0.59
20" (508mm)	12" (305mm)	0.22	0.22	0.22	0.17	0.22	0.17
	18" (457mm)	0.33	0.31	0.31	0.22	0.31	0.22
	24" (610mm)	0.33	0.39	0.33	0.33	0.39	0.33
	30" (762mm)	0.67	0.47	0.47	0.33	0.47	0.33
	36" (914mm)	0.67	0.56	0.56	0.67	0.56	0.56
	42" (1067mm)	0.67	0.64	0.64	0.67	0.64	0.64
	48" (1219mm)	0.67	0.72	0.67	0.67	0.72	0.67
	54" (1372mm)	N/A	0.81	0.81	0.67	0.81	0.67
	60" (1529mm)	N/A	0.89	0.89	0.67	0.89	0.67

COM Yardage Requirements

UniGroup

Actual (Inches) Height	Width	54 Inch Roll (Linear Yards)			66 Inch Roll (Linear Yards)		
		Directional Rightway	Directional Railroad	Non- directional	Directional Rightway	Directional Railroad	Non- directional
Add-On Panel (continued)							
24" (610mm)	12" (305mm)	0.26	0.22	0.22	0.19	0.22	0.19
	18" (457mm)	0.39	0.31	0.31	0.26	0.31	0.26
	24" (610mm)	0.39	0.39	0.39	0.39	0.39	0.39
	30" (762mm)	0.78	0.47	0.47	0.39	0.47	0.39
	36" (914mm)	0.78	0.56	0.56	0.78	0.56	0.56
	42" (1067mm)	0.78	0.64	0.64	0.78	0.64	0.64
	48" (1219mm)	0.78	0.72	0.72	0.78	0.72	0.72
	54" (1372mm)	N/A	0.81	0.81	0.78	0.81	0.78
	60" (1529mm)	N/A	0.89	0.89	0.78	0.89	0.78
Wainscot Panel							
*	12" (305mm)	0.20	0.36	0.20	0.16	0.18	0.16
	18" (457mm)	0.40	0.53	0.40	0.27	0.26	0.26
	24" (610mm)	0.40	0.69	0.40	0.40	0.35	0.35
	36" (914mm)	0.81	1.03	0.81	0.81	0.51	0.51
	48" (1219mm)	0.81	1.36	0.81	0.81	0.68	0.68
	60" (1529mm)	N/A	1.69	1.69	0.81	0.85	0.81

*Usage for 67"/68" and 81"/82" high panels

Actual (Inches) Height	Width	54 Inch Roll (Linear Yards)			66 Inch Roll (Linear Yards)		
		Directional Rightway	Directional Railroad	Non- directional	Directional Rightway	Directional Railroad	Non- directional
Finish Posts							
30" (762mm)		0.10	0.10	0.10	0.08	0.10	0.08
37" (940mm)		0.13	0.19	0.13	0.10	0.10	0.10
44" (1118mm)		0.16	0.19	0.16	0.12	0.19	0.12
50" (1270mm)		0.18	0.19	0.18	0.14	0.19	0.14
56" (1422mm)		0.21	0.19	0.19	0.16	0.19	0.15
64" (1626mm)		0.24	N/A	0.24	0.19	0.19	0.19
68" (1727mm)		0.25	N/A	0.25	0.20	0.19	0.19
82" (2083mm)		0.31	N/A	0.31	0.24	N/A	0.24

Actual (Inches) Height	Width	54 Inch Roll (Linear Yards)			66 Inch Roll (Linear Yards)		
		Directional Rightway	Directional Railroad	Non- directional	Directional Rightway	Directional Railroad	Non- directional
Flipper Doors							
16 3/4" (425mm)	24" (610mm)	0.61	0.42	0.42	0.31	0.28	0.28
	30" (762mm)	0.61	0.50	0.50	0.61	0.33	0.33
	36" (914mm)	0.61	0.58	0.58	0.61	0.39	0.39
	42" (1067mm)	0.61	0.67	0.61	0.61	0.44	0.44
	48" (1219mm)	0.61	0.75	0.61	0.61	0.50	0.50
	60" (1529mm)	N/A	0.92	0.92	0.61	0.61	0.61

COM Yardage Requirements

UniGroup

Actual (Inches) Height	Width	54 Inch Roll (Linear Yards)			66 Inch Roll (Linear Yards)		
		Directional Rightway	Directional Railroad	Non- directional	Directional Rightway	Directional Railroad	Non- directional
Tackboard and Tack Strip							
5" (127mm)	24" (610mm)	0.31	0.21	0.21	0.31	0.14	0.14
	30" (762mm)	0.31	0.25	0.25	0.31	0.17	0.17
	36" (914mm)	0.31	0.29	0.29	0.31	0.19	0.19
	42" (1067mm)	0.31	0.33	0.31	0.31	0.22	0.22
	48" (1219mm)	0.31	0.38	0.31	0.31	0.25	0.25
	60" (1529mm)	N/A	0.46	0.46	0.31	0.31	0.31
11" (279mm)	24" (610mm)	0.47	0.42	0.42	0.47	0.28	0.28
	30" (762mm)	0.47	0.50	0.47	0.47	0.33	0.33
	36" (914mm)	0.47	0.58	0.47	0.47	0.39	0.39
	42" (1067mm)	0.47	0.67	0.47	0.47	0.44	0.44
	48" (1219mm)	0.47	0.75	0.47	0.47	0.50	0.47
	54" (1371mm)	N/A	0.83	0.83	0.47	0.56	0.47
16" (406mm)	24" (610mm)	0.61	0.42	0.42	0.61	0.28	0.28
	30" (762mm)	0.61	0.50	0.50	0.61	0.33	0.33
	36" (914mm)	0.61	0.58	0.58	0.61	0.39	0.39
	42" (1067mm)	0.61	0.67	0.61	0.61	0.44	0.44
	48" (1219mm)	0.61	0.75	0.61	0.61	0.50	0.50
	54" (1371mm)	N/A	0.83	0.83	0.61	0.56	0.56
33" (838mm)	24" (610mm)	1.08	0.83	0.83	1.08	0.83	0.83
	30" (762mm)	1.08	1.00	1.00	1.08	1.00	1.00
	36" (914mm)	1.08	1.17	1.08	1.08	1.17	1.08
	42" (1067mm)	1.08	1.33	1.08	1.08	1.33	1.08
	48" (1219mm)	1.08	1.50	1.08	1.08	1.50	1.08
	54" (1371mm)	N/A	1.67	1.67	1.08	1.67	1.08
	60" (1529mm)	N/A	1.83	1.83	1.08	1.83	1.08

COM Yardage Requirements

PLACES

Actual (Inches) Height	Width	54"(1372m) Roll (Linear Yards)			66"(1676m) Roll (Linear Yards)		
		Directional Rightway	Directional Railroad	Non- directional	Directional Rightway	Directional Railroad	Non- directional
Straight Panels							
30"(762mm)	12"(305mm)	0.28	0.44	0.28	0.21	0.22	0.21
	18"(457mm)	0.42	0.61	0.42	0.28	0.31	0.28
	24"(610mm)	0.42	0.78	0.42	0.42	0.39	0.39
	30"(762mm)	0.83	0.94	0.83	0.42	0.47	0.42
	36"(914mm)	0.83	1.11	0.83	0.83	0.56	0.56
	42"(1067mm)	0.83	1.28	0.83	0.83	0.64	0.64
	48"(1219mm)	0.83	1.44	0.83	0.83	0.72	0.72
	54"(1372mm)	N/A	1.61	1.61	0.83	0.81	0.81
	60"(1524mm)	N/A	1.78	1.78	0.83	0.89	0.83
37"(940mm)	12"(305mm)	0.34	0.44	0.34	0.26	0.44	0.26
	18"(457mm)	0.51	0.61	0.51	0.34	0.61	0.34
	24"(610mm)	0.51	0.78	0.51	0.51	0.78	0.51
	30"(762mm)	1.03	0.94	0.94	0.51	0.94	0.51
	36"(914mm)	1.03	1.11	1.03	1.03	1.11	1.03
	42"(1067mm)	1.03	1.28	1.03	1.03	1.28	1.03
	48"(1219mm)	1.03	1.44	1.03	1.03	1.44	1.03
	54"(1372mm)	N/A	1.61	1.61	1.03	1.61	1.03
	60"(1524mm)	N/A	1.78	1.78	1.03	1.78	1.03
44"(1118mm)	12"(305mm)	0.41	0.44	0.41	0.31	0.44	0.31
	18"(457mm)	0.61	0.61	0.61	0.41	0.61	0.41
	24"(610mm)	0.61	0.78	0.61	0.61	0.78	0.61
	30"(762mm)	1.22	0.94	0.94	0.61	0.94	0.61
	36"(914mm)	1.22	1.11	1.11	1.22	1.11	1.11
	42"(1067mm)	1.22	1.28	1.22	1.22	1.28	1.22
	48"(1219mm)	1.22	1.44	1.22	1.22	1.44	1.22
	54"(1372mm)	N/A	1.61	1.61	1.22	1.61	1.22
	60"(1524mm)	N/A	1.78	1.78	1.22	1.78	1.22
50"(1270mm)	12"(305mm)	0.46	0.44	0.44	0.35	0.44	0.35
	18"(457mm)	0.69	0.61	0.61	0.46	0.61	0.46
	24"(610mm)	0.69	0.78	0.69	0.69	0.78	0.69
	30"(762mm)	1.39	0.94	0.94	0.69	0.94	0.69
	36"(914mm)	1.39	1.11	1.11	1.39	1.11	1.11
	42"(1067mm)	1.39	1.28	1.28	1.39	1.28	1.28
	48"(1219mm)	1.39	1.44	1.39	1.39	1.44	1.39
	54"(1372mm)	N/A	1.61	1.61	1.39	1.61	1.39
	60"(1524mm)	N/A	1.78	1.78	1.39	1.78	1.39
56"(1422mm)	12"(305mm)	0.52	0.44	0.44	0.39	0.44	0.39
	18"(457mm)	0.78	0.61	0.61	0.52	0.61	0.52
	24"(610mm)	0.78	0.78	0.78	0.78	0.78	0.78
	30"(762mm)	1.56	0.94	0.94	0.78	0.94	0.78
	36"(914mm)	1.56	1.11	1.11	1.56	1.11	1.11
	42"(1067mm)	1.56	1.28	1.28	1.56	1.28	1.28
	48"(1219mm)	1.56	1.44	1.44	1.56	1.44	1.44
	54"(1372mm)	N/A	1.61	1.61	1.56	1.61	1.56
	60"(1524mm)	N/A	1.78	1.78	1.56	1.78	1.56
64"(1626mm)	12"(305mm)	0.59	N/A	0.59	0.44	0.44	0.44
	18"(457mm)	0.89	N/A	0.89	0.59	0.61	0.59
	24"(610mm)	0.89	N/A	0.89	0.89	0.78	0.78
	30"(762mm)	1.78	N/A	1.78	0.89	0.94	0.89
	36"(914mm)	1.78	N/A	1.78	1.78	1.11	1.11
	42"(1067mm)	1.78	N/A	1.78	1.78	1.28	1.28
	48"(1219mm)	1.78	N/A	1.78	1.78	1.44	1.44
	54"(1372mm)	N/A	N/A	N/A	1.78	1.61	1.61
	60"(1524mm)	N/A	N/A	N/A	1.78	1.78	1.78

COM Yardage Requirements

PLACES

Actual (Inches) Height	Width	54"(1372mm) Roll (Linear Yards)			66"(1676mm) Roll (Linear Yards)		
		Directional Rightway	Directional Railroad	Non- directional	Directional Rightway	Directional Railroad	Non- directional
Straight Panels (Continued)							
68"(1727mm)	12"(305mm)	0.63	N/A	0.63	0.47	0.44	0.44
	18"(457mm)	0.94	N/A	0.94	0.63	0.61	0.61
	24"(610mm)	0.94	N/A	0.94	0.94	0.78	0.78
	30"(762mm)	1.89	N/A	1.89	0.94	0.94	0.94
	36"(914mm)	1.89	N/A	1.89	1.89	1.11	1.11
	42"(1067mm)	1.89	N/A	1.89	1.89	1.28	1.28
	48"(1219mm)	1.89	N/A	1.89	1.89	1.44	1.44
	54"(1372mm)	N/A	N/A	N/A	1.89	1.61	1.61
	60"(1524mm)	N/A	N/A	N/A	1.89	1.78	1.78
82"(2083mm)	12"(305mm)	0.76	N/A	0.79	0.57	N/A	0.57
	18"(457mm)	1.14	N/A	1.14	0.76	N/A	0.76
	24"(610mm)	1.14	N/A	1.14	1.14	N/A	1.14
	30"(762mm)	2.28	N/A	2.28	1.14	N/A	1.14
	36"(914mm)	2.28	N/A	2.28	2.28	N/A	2.28
	42"(1067mm)	2.28	N/A	2.28	2.28	N/A	2.28
	48"(1219mm)	2.28	N/A	2.28	2.28	N/A	2.28
	54"(1372mm)	N/A	N/A	N/A	2.28	N/A	2.28
	60"(1524mm)	N/A	N/A	N/A	2.28	N/A	2.28

Actual (Inches) Height	Width	54"(1372mm) Roll (Linear Yards)			66"(1676mm) Roll (Linear Yards)		
		Directional Rightway	Directional Railroad	Non- directional	Directional Rightway	Directional Railroad	Non- directional
Wainscot Panels							
*	12"(305mm)	0.20	0.36	0.20	0.16	0.18	0.16
	18"(457mm)	0.40	0.53	0.40	0.27	0.26	0.26
	24"(610mm)	0.40	0.69	0.40	0.40	0.35	0.35
	30"(762mm)	0.81	0.86	0.81	0.40	0.43	0.40
	36"(914mm)	0.81	1.03	0.81	0.81	0.51	0.51
	42"(1067mm)	0.81	1.19	0.81	0.81	0.60	0.60
	48"(1219mm)	0.81	1.36	0.81	0.81	0.68	0.68
	54"(1372mm)	0.81	1.53	0.81	0.81	0.76	0.76
	60"(1524mm)	N/A	1.69	1.69	0.81	0.85	0.81

*Usage for 68" and 82" wainscot panel with muntins and 30"-high wainscot kit.

COM Yardage Requirements

PLACES

Actual (Inches) Height	Width	54"(1372mm) Roll (Linear Yards)			66"(1676mm) Roll (Linear Yards)		
		Directional Rightway	Directional Railroad	Non- directional	Directional Rightway	Directional Railroad	Non- directional
Add-on Panels							
12"(305mm)	12"(305mm)	0.15	0.15	0.15	0.11	0.11	0.11
	18"(457mm)	0.22	0.21	0.21	0.15	0.15	0.15
	24"(610mm)	0.22	0.26	0.22	0.22	0.20	0.20
	30"(762mm)	0.45	0.32	0.32	0.22	0.24	0.22
	36"(914mm)	0.45	0.37	0.37	0.45	0.28	0.28
	42"(1067mm)	0.45	0.43	0.43	0.45	0.32	0.32
	48"(1219mm)	0.45	0.48	0.45	0.45	0.36	0.36
	54"(1372mm)	N/A	0.54	0.54	0.45	0.40	0.40
	60"(1524mm)	N/A	0.59	0.59	0.45	0.45	0.45
14"(356mm)	12"(305mm)	0.17	0.15	0.15	0.13	0.15	0.13
	18"(457mm)	0.25	0.21	0.21	0.17	0.21	0.17
	24"(610mm)	0.25	0.26	0.25	0.25	0.26	0.25
	30"(762mm)	0.50	0.32	0.32	0.25	0.32	0.25
	36"(914mm)	0.50	0.37	0.37	0.50	0.37	0.37
	42"(1067mm)	0.50	0.43	0.43	0.50	0.43	0.43
	48"(1219mm)	0.50	0.48	0.48	0.50	0.48	0.48
	54"(1372mm)	N/A	0.54	0.54	0.50	0.54	0.50
	60"(1524mm)	N/A	0.59	0.59	0.50	0.59	0.50
18"(457mm)	12"(305mm)	0.21	0.22	0.21	0.15	0.15	0.15
	18"(457mm)	0.31	0.31	0.31	0.21	0.21	0.21
	24"(610mm)	0.31	0.39	0.31	0.31	0.26	0.26
	30"(762mm)	0.61	0.47	0.47	0.31	0.32	0.31
	36"(914mm)	0.61	0.56	0.56	0.62	0.37	0.37
	42"(1067mm)	0.61	0.64	0.61	0.61	0.43	0.43
	48"(1219mm)	0.61	0.72	0.61	0.61	0.48	0.48
	54"(1372mm)	N/A	0.81	0.81	0.61	0.54	0.54
	60"(1524mm)	N/A	0.89	0.89	0.61	0.59	0.59
20"(508mm)	12"(305mm)	0.22	0.22	0.22	0.17	0.22	0.17
	18"(457mm)	0.34	0.31	0.31	0.22	0.31	0.22
	24"(610mm)	0.34	0.39	0.34	0.34	0.39	0.34
	30"(762mm)	0.67	0.47	0.47	0.34	0.47	0.34
	36"(914mm)	0.67	0.56	0.56	0.67	0.56	0.56
	42"(1067mm)	0.67	0.64	0.64	0.67	0.64	0.64
	48"(1219mm)	0.67	0.72	0.67	0.67	0.72	0.67
	54"(1372mm)	N/A	0.81	0.81	0.67	0.81	0.67
	60"(1524mm)	N/A	0.89	0.89	0.67	0.89	0.67
24"(610mm)	12"(305mm)	0.26	0.22	0.22	0.20	0.22	0.20
	18"(457mm)	0.39	0.31	0.31	0.26	0.31	0.26
	24"(610mm)	0.39	0.39	0.39	0.39	0.39	0.39
	30"(762mm)	0.78	0.47	0.47	0.39	0.47	0.39
	36"(914mm)	0.78	0.56	0.56	0.78	0.56	0.56
	42"(1067mm)	0.78	0.64	0.64	0.78	0.64	0.64
	48"(1219mm)	0.78	0.72	0.72	0.78	0.72	0.72
	54"(1372mm)	N/A	0.81	0.81	0.78	0.81	0.78
	60"(1524mm)	N/A	0.89	0.89	0.78	0.89	0.78

COM Yardage Requirements

PLACES

Actual (Inches) Height	Width	54"(1372mm) Roll (Linear Yards)			66"(1676mm) Roll (Linear Yards)		
		Directional Rightway	Directional Railroad	Non- directional	Directional Rightway	Directional Railroad	Non- directional
Tackboards and Tackstrips							
5"(127mm)	24"(610mm)	0.31	0.21	0.21	0.31	0.14	0.14
	30"(762mm)	0.31	0.25	0.25	0.31	0.17	0.17
	36"(914mm)	0.31	0.29	0.29	0.31	0.19	0.19
	42"(1067mm)	0.31	0.33	0.31	0.31	0.22	0.22
	48"(1219mm)	0.31	0.38	0.31	0.31	0.25	0.25
	60"(1524mm)	N/A	0.46	0.46	0.31	0.31	0.31
11"(279mm)	24"(610mm)	0.47	0.42	0.42	0.47	0.28	0.28
	30"(762mm)	0.47	0.50	0.47	0.47	0.33	0.33
	36"(914mm)	0.47	0.58	0.47	0.47	0.39	0.39
	42"(1067mm)	0.47	0.67	0.47	0.47	0.44	0.44
	48"(1219mm)	0.47	0.75	0.47	0.47	0.50	0.47
	54"(1372mm)	N/A	0.83	0.83	0.47	0.56	0.47
	60"(1524mm)	N/A	0.92	0.92	0.47	0.61	0.47
16"(406mm)	24"(610mm)	0.61	0.42	0.42	0.61	0.28	0.28
	30"(762mm)	0.61	0.50	0.50	0.61	0.33	0.33
	36"(914mm)	0.61	0.58	0.58	0.61	0.39	0.39
	42"(1067mm)	0.61	0.67	0.61	0.61	0.44	0.44
	48"(1219mm)	0.61	0.75	0.61	0.61	0.50	0.50
	54"(1372mm)	N/A	0.83	0.83	0.61	0.56	0.56
	60"(1524mm)	N/A	0.92	0.92	0.61	0.61	0.61
33"(838mm)	24"(610mm)	1.08	0.83	0.83	1.08	0.83	0.83
	30"(762mm)	1.08	1.00	1.00	1.08	1.00	1.00
	36"(914mm)	1.08	1.17	1.08	1.08	1.17	1.08
	42"(1067mm)	1.08	1.33	1.08	1.08	1.33	1.08
	48"(1219mm)	1.08	1.50	1.08	1.08	1.50	1.08
	54"(1372mm)	N/A	1.67	1.67	1.08	1.67	1.08
	60"(1524mm)	N/A	1.83	1.83	1.08	1.83	1.08

COM Yardage Requirements

PLACES

Actual (Inches) Height	Width	54"(1372mm) Roll (Linear Yards)			66"(1676mm) Roll (Linear Yards)		
		Directional Rightway	Directional Railroad	Non- directional	Directional Rightway	Directional Railroad	Non- directional
Flipper Doors							
15.6"(397mm)	24"(610mm)	0.61	0.42	0.42	0.31	0.28	0.28
	30"(762mm)	0.61	0.50	0.50	0.61	0.33	0.33
	36"(914mm)	0.61	0.58	0.58	0.61	0.39	0.39
	42"(1067mm)	0.61	0.67	0.61	0.61	0.44	0.44
	48"(1219mm)	0.61	0.75	0.61	0.61	0.50	0.50
	54"(1372mm)	N/A	0.83	0.83	0.61	0.56	0.56
	60"(1524mm)	N/A	0.92	0.92	0.61	0.61	0.61
16.75"(425mm)	24"(610mm)	0.61	0.42	0.42	0.31	0.28	0.28
	30"(762mm)	0.61	0.50	0.50	0.61	0.33	0.33
	36"(914mm)	0.61	0.58	0.58	0.61	0.39	0.39
	42"(1067mm)	0.61	0.67	0.61	0.61	0.44	0.44
	48"(1219mm)	0.61	0.75	0.61	0.61	0.50	0.50
	54"(1372mm)	N/A	0.83	0.83	0.61	0.56	0.56
	60"(1524mm)	N/A	0.92	0.92	0.61	0.61	0.61
Finish Posts — 90°, 120°, 135°, 180° and End of Run							
	30"(762mm)	0.10	0.10	0.10	0.08	0.10	0.08
	37"(940mm)	0.13	0.19	0.13	0.10	0.10	0.10
	44"(1118mm)	0.16	0.19	0.16	0.12	0.19	0.12
	50"(1270mm)	0.18	0.19	0.18	0.14	0.19	0.14
	56"(1422mm)	0.21	0.19	0.19	0.16	0.19	0.16
	64"(1626mm)	0.24	N/A	0.24	0.19	0.19	0.19
	68"(1727mm)	0.25	N/A	0.25	0.20	0.19	0.19
	82"(2083mm)	0.31	N/A	0.31	0.24	N/A	0.24
Variable Height End of Run Posts							
	4"(102mm)	0.02	0.02	0.02	0.01	0.01	0.01
	6"(152mm)	0.03	0.02	0.02	0.02	0.02	0.02
	7"(178mm)	0.03	0.03	0.03	0.02	0.02	0.02
	8"(203mm)	0.03	0.03	0.03	0.03	0.03	0.03
	12"(305mm)	0.05	0.05	0.05	0.04	0.04	0.04
	13"(330mm)	0.05	0.06	0.05	0.04	0.05	0.04
	14"(356mm)	0.06	0.06	0.06	0.05	0.05	0.05
	18"(457mm)	0.07	0.10	0.07	0.06	0.06	0.06
	19"(483mm)	0.08	0.10	0.08	0.06	0.06	0.06
	20"(508mm)	0.08	0.10	0.08	0.06	0.06	0.06
	24"(610mm)	0.10	0.10	0.10	0.08	0.10	0.08
	26"(660mm)	0.11	0.10	0.10	0.08	0.10	0.08
	27"(686mm)	0.11	0.19	0.11	0.09	0.10	0.09
	31"(787mm)	0.13	0.19	0.13	0.10	0.10	0.10
	32"(813mm)	0.13	0.19	0.13	0.10	0.10	0.10
	34"(864mm)	0.14	0.19	0.14	0.11	0.19	0.11
	38"(965mm)	0.15	0.19	0.15	0.12	0.19	0.12
	45"(1143mm)	0.18	0.19	0.18	0.14	0.19	0.14
	52"(1321mm)	0.21	0.19	0.19	0.16	0.19	0.16

COM Yardage Requirements

PLACES

Actual (Inches) Height	Width	54"(1372mm) Roll (Linear Yards)			66"(1676m) Roll (Linear Yards)		
		Directional Rightway	Directional Railroad	Non- directional	Directional Rightway	Directional Railroad	Non- directional
Cable Management Posts — Variable Height							
4"(102mm)		0.02	0.02	0.02	0.01	0.01	0.01
6"(152mm)		0.03	0.02	0.03	0.02	0.02	0.02
7"(178mm)		0.04	0.03	0.04	0.02	0.02	0.02
8"(203mm)		0.04	0.03	0.04	0.03	0.03	0.03
12"(305mm)		0.06	0.05	0.06	0.04	0.04	0.04
13"(330mm)		0.06	0.06	0.06	0.04	0.05	0.04
14"(356mm)		0.07	0.06	0.07	0.05	0.05	0.05
18"(457mm)		0.09	0.10	0.09	0.06	0.06	0.06
19"(483mm)		0.09	0.10	0.09	0.06	0.06	0.06
20"(508mm)		0.10	0.10	0.10	0.06	0.06	0.06
24"(610mm)		0.11	0.10	0.11	0.08	0.10	0.08
26"(660mm)		0.12	0.10	0.12	0.08	0.10	0.08
27"(686mm)		0.13	0.19	0.13	0.09	0.10	0.09
31"(787mm)		0.15	0.19	0.15	0.10	0.10	0.10
32"(813mm)		0.15	0.19	0.15	0.10	0.10	0.10
34"(864mm)		0.16	0.19	0.16	0.11	0.19	0.11
38"(965mm)		0.18	0.19	0.18	0.12	0.19	0.12
45"(1143mm)		0.21	0.19	0.19	0.14	0.19	0.14
52"(1321mm)		0.24	0.19	0.19	0.16	0.19	0.16

Products are listed alphabetically in this index by alpha-numeric prefix/suffix codes.

Product Code	Product Description	Page
2371-6401	Panel Accessories – Panel Bridge	132
7031-0501	Panel Accessories – Friction Pad	78
7031-0501	Panel Accessories – Friction Pad	109
7031-0501	Panel Accessories – Friction Pad	135
7031-7001	Markerboard Accessories – Markerboard Accessories	242
7031-7002	Markerboard Accessories – Markerboard Accessories	242
7062-8001	Markerboard Accessories – Markerboard Accessories	242
BFM-1-B	Electrical Components – Base Feed Module – Hardwire Connection	145
BFM-1-B2	Electrical Components – Base Feed Module – Hardwire Connection	145
BFM-1-B4	Electrical Components – Base Feed Module – Hardwire Connection	145
BFM-1-C	Electrical Components — Hardwire – Base Feed Kit	167
BFM-2-A	Electrical Components – Single Circuit Base Feed Module – Receptacle Connection with Power Cord	146
BFM-2-A2	Electrical Components – Single Circuit Base Feed Module – Receptacle Connection with Power Cord	146
BFM-2-A4	Electrical Components – Single Circuit Base Feed Module – Receptacle Connection with Power Cord	146
BFM-2-B	Electrical Components – Single Circuit Base Feed Module – Receptacle Connection with Power Cord	145
BFM-2-B2	Electrical Components – Single Circuit Base Feed Module – Receptacle Connection with Power Cord	145
BFM-2-B4	Electrical Components – Single Circuit Base Feed Module – Receptacle Connection with Power Cord	145
BFM-6-B	Electrical Components – Base Feed Module — Concealed Hardwire Connection	147
BFM-6-B2	Electrical Components – Base Feed Module — Concealed Hardwire Connection	147
BFM-6-B4	Electrical Components – Base Feed Module — Concealed Hardwire Connection	147
BPM-1-C	Electrical Components — Hardwire – Blank Cover Plate	167
CH-8	Panel Accessories – All-Purpose Hook	109
CMPF-1-BR	Electrical and Cable Management Accessories – Cable Management Pole — One Channel – UniGroup Too and UniGroup Only	160
CMPT-1-B	Electrical and Cable Management Accessories – Cable Management Pole — Two Channels – UniGroup Too and UniGroup Only	160
E2AG	Glazed Add-On Panel – Glazed	67
E2AL-1	Panel Accessories – UniGroup Too Top Cap Aligner	75
E2AM	Fabric Add-On Panel – Fabric	66
E2BN-B	Monolithic Panel Core without Insert(s) — No Power – Panel Core	56
E2BP-2	Monolithic Panel Core without Insert(s) — Powered – Panel Core	58
E2BP-4	Monolithic Panel Core without Insert(s) — Powered – Panel Core	58
E2BP-B	Monolithic Panel Core without Insert(s) — Powered – Panel Core	58
E2CA-120	Panel Accessories – 120° Square Painted Top Cap for 2-Way or 3-Way	74
E2CC-90	Panel Accessories – 90° Square Painted Top Cap for 2-Way, 3-Way, 4-Way	74
E2CH-8	Panel Accessories – All-Purpose Hook	78
E2DN-B	Laminate Monolithic Panel — No Power – Laminate	28
E2DP-2	Laminate Monolithic Panel — Powered – Laminate	30
E2DP-4	Laminate Monolithic Panel — Powered – Laminate	30
E2DP-B	Laminate Monolithic Panel — Powered – Laminate	30
E2DS	Swing Door – Single Door — Laminate	69
E2EC-1	Panel Accessories – UniGroup Too Top Cap End Plug	75
E2FM	Electrical Components – Top Feed Module — UniGroup Too Only	150
E2FM-2	Electrical Components – Top Feed Module — UniGroup Too Only	150
E2FM-4	Electrical Components – Top Feed Module — UniGroup Too Only	150
E2FM-NT	Electrical Components — Hardwire / International – Top Feed Module – Hardwire / International – UniGroup Too Only	168
E2FM-X	Electrical Components – Top Feed Module — UniGroup Too Only	150
E2FN-B	Fabric Monolithic Panel — No Power – Fabric	33
E2FP-2	Fabric Monolithic Panel — Powered – Fabric	37
E2FP-4	Fabric Monolithic Panel — Powered – Fabric	37
E2FP-B	Fabric Monolithic Panel — Powered – Fabric	37
E2FS	Panel Accessories – 180° Full-Height Finish Post — Square Painted Top Cap	72
E2FS-N	Panel Accessories – 180° Vertical Cover only, (no top cap or base raceway cover)	73

Index

<u>Product Code</u>	<u>Product Description</u>	<u>Page</u>
E2FS-V	Panel Accessories – 180° Variable-Height Finish Post — Square Painted Top Cap	.72
E2GN-B	Glazed Monolithic Panel — No Power – Glazed	.60
E2GP-2	Glazed Monolithic Panel — Powered – Glazed	.62
E2GP-4	Glazed Monolithic Panel — Powered – Glazed	.62
E2GP-B	Glazed Monolithic Panel — Powered – Glazed	.62
E2JF	Base Insert – Base Insert — Fabric	.64
E2LN-B	Monolithic Panel with Full-Height Inserts — No Power – Fabric Inserts	.41
E2LP-2	Monolithic Panel with Full-Height Inserts — Powered – Fabric Inserts	.45
E2LP-4	Monolithic Panel with Full-Height Inserts — Powered – Fabric Inserts	.45
E2LP-B	Monolithic Panel with Full-Height Inserts — Powered – Fabric Inserts	.45
E2MN-B	Basic Monolithic Panel — No Power – Fabric	.21
E2MP-2	Basic Monolithic Panel — Powered – Fabric	.25
E2MP-4	Basic Monolithic Panel — Powered – Fabric	.25
E2MP-B	Basic Monolithic Panel — Powered – Fabric	.25
E2PA	Panel Accessories – 120° Full-Height Finish Post — Square Painted Top Cap	.71
E2PA-V	Panel Accessories – 120° Variable-Height Finish Post — Square Painted Top Cap	.71
E2PC	Panel Accessories – 90° Full-Height Finish Post — Square Painted Top Cap	.70
E2PC-120-B	Panel Accessories – 120° Power Connector Cover	.71
E2PC-90-B	Panel Accessories – 90° Power Connector Cover — Square Profile	.70
E2PC-V	Panel Accessories – 90° Variable-Height Finish Post — Square Painted Top Cap	.70
E2PS	Panel Accessories – 180° Full-Height Finish Post — Square Painted Top Cap	.72
E2PS-N	Panel Accessories – 180° Vertical Cover only, (no top cap or base raceway cover)	.73
E2PS-V	Panel Accessories – 180° Variable-Height Finish Post — Square Painted Top Cap	.72
E2SN-B	Monolithic Panel with Segmented Inserts — No Power – Fabric Inserts	.49
E2SP-2	Monolithic Panel with Segmented Inserts — Powered – Fabric Inserts	.53
E2SP-4	Monolithic Panel with Segmented Inserts — Powered – Fabric Inserts	.53
E2SP-B	Monolithic Panel with Segmented Inserts — Powered – Fabric Inserts	.53
E2TF	Upper Inserts – Upper Insert — Fabric or Markerboard	.65
E2TK	Panel Accessories – T-Mount Kits	.78
E2TM	Upper Inserts – Upper Insert — Fabric or Markerboard	.65
E2TS-P	Panel Accessories – Retrofit Kits – Square Painted Top Caps	.140
E2TS-T	Panel Accessories – Retrofit Kits – Square Painted Top Caps	.136
E2TS-U	Panel Accessories – Retrofit Kits – Square Painted Top Caps	.136
E2UR-A	Panel Accessories – Retrofit Kits – Trim Strip for UniGroup Fabric and Glazed Add-On Panels	.136
EAC-4280-BHL	Swing Doors with Steel Top Cap – Single Door with ADA Lever and Kick Plate — Laminate	.104
EAF	Fabric Add-On Panel – Fabric	.100
EAG	Glazed Add-On Panel – Glazed	.102
EBEJ-0072-2WF	Electrical Components – Raised Floor Base Feed Module	.147
EBEJ-0072-3WF	Electrical Components – Raised Floor Base Feed Module	.147
EBEJ-0072-4WF	Electrical Components – Raised Floor Base Feed Module	.147
EC-10-B	Electrical and Cable Management Accessories – Base Raceway End Cap	.159
EC-10-B	Panel Accessories – Base Raceway End Cap	.75
EDG-BHL	Swing Doors with Steel Top Cap – Single Door — Glazed	.105
EDG-BKL	Swing Doors with Steel Top Cap – Single Door — Glazed	.105
EDN-B	Laminate Monolithic Panel with Steel Top Cap — No Power – Laminate	.88
EDP-2	Laminate Monolithic Panel with Steel Top Cap — Powered – Laminate	.90
EDP-4	Laminate Monolithic Panel with Steel Top Cap — Powered – Laminate	.90
EDP-B	Laminate Monolithic Panel with Steel Top Cap — Powered – Laminate	.90
EDS-BHL	Swing Doors with Steel Top Cap – Single Door — Laminate	.104
EDS-BKL	Swing Doors with Steel Top Cap – Single Door — Laminate	.104
EFN-B	Monolithic Panel with Steel Top Cap — No Power – Fabric	.80
EFF-2	Monolithic Panel with Steel Top Cap — Powered – Fabric	.82
EFF-4	Monolithic Panel with Steel Top Cap — Powered – Fabric	.82

Product Code	Product Description	Page
EFP-B	Monolithic Panel with Steel Top Cap — Powered – Fabric	.82
EGN-B	Glazed Monolithic Panel with Steel Top Cap — No Power – Glazed	.96
EGP-2	Glazed Monolithic Panel with Steel Top Cap — Powered – Glazed	.98
EGP-4	Glazed Monolithic Panel with Steel Top Cap — Powered – Glazed	.98
EGP-B	Glazed Monolithic Panel with Steel Top Cap — Powered – Glazed	.98
EMN-B	Basic Monolithic Panel with Steel Top Cap — No Power – Fabric	.84
EMP-2	Basic Monolithic Panel with Steel Top Cap — Powered – Fabric	.86
EMP-4	Basic Monolithic Panel with Steel Top Cap — Powered – Fabric	.86
EMP-B	Basic Monolithic Panel with Steel Top Cap — Powered – Fabric	.86
EON-B	Open Frame Panel with Steel Top Cap — No Power – Open-Frame	.92
EOP-2	Open Frame Panel with Steel Top Cap — Powered – Open-Frame	.94
EOP-4	Open Frame Panel with Steel Top Cap — Powered – Open-Frame	.94
EOP-B	Open Frame Panel with Steel Top Cap — Powered – Open-Frame	.94
ETCR	Electrical and Cable Management Accessories – Expanded Top Cap Raceway – UniGroup Only	.165
EVEJ-2WF	Electrical Components – Internal Power Base AI Feed	.148
EVEJ-3WF	Electrical Components – Internal Power Base AI Feed	.148
EVEJ-4WF	Electrical Components – Internal Power Base AI Feed	.148
FBEW	Electrical Components – Wall Feed Field Wired 1 Port	.148
FC-1	Electrical and Cable Management Accessories – Expanded Top Finish Cap – UniGroup Only	.165
FC-2	Electrical and Cable Management Accessories – Expanded Top Finish Cap – UniGroup Only	.165
FC-3	Electrical and Cable Management Accessories – Expanded Top Finish Cap – UniGroup Only	.165
FC-4	Electrical and Cable Management Accessories – Expanded Top Finish Cap – UniGroup Only	.165
FC-90	Electrical and Cable Management Accessories – Expanded Top Finish Cap – UniGroup Only	.165
FPC-2	Panel Accessories – Steel Top Cap for 3-Way and 4-Way	.106
FPPC-B	Panel Accessories – 90° Finish Post — for Steel Top Cap — Painted Surface	.106
FPPS-B	Panel Accessories – 180° Finish Post — for Steel Top Cap — Painted Surface	.106
H2PC	Panel Accessories – Retrofit Kits – 90° Full-Height Finish Post — Square Painted Top Cap	.140
H2PC-V	Panel Accessories – Retrofit Kits – 90° Variable-Height Finish Post — Square Painted Top Cap	.140
H2PS	Panel Accessories – Retrofit Kits – 180° Full-Height Finish Post — Square Painted Top Cap	.141
H2PS-V	Panel Accessories – Retrofit Kits – 180° Variable-Height Finish Post — Square Painted Top Cap	.141
HAB	Panel Accessories – Seismic Anchoring Bracket	.78
HAB	Panel Accessories – Seismic Anchoring Bracket	.109
HAB	Panel Accessories – Seismic Anchoring Bracket	.135
HAF	Fabric Add-On Panel – Fabric	.126
HAG	Glazed Add-On Panel – Glazed	.128
HCCP-V4	Electrical and Cable Management Accessories – Cable Management Post – Variable Height – Three-Way 90° – PLACES Only	.164
HCH-0008	Panel Accessories – All-Purpose Hook	.135
HCPA	Electrical and Cable Management Accessories – Cable Management Pole – Panel Height – PLACES Only	.161
HCPA	Electrical and Cable Management Accessories – Cable Management Pole – for 10'(3048mm)-High Ceiling – PLACES Only	.161
HCPA	Electrical and Cable Management Accessories – Cable Management Pole – for 12'(3658mm)-High Ceiling – PLACES Only	.162
HCPE	Electrical and Cable Management Accessories – Cable Management Pole – for 10'(3048mm)-High Ceiling – PLACES Only	.161
HCPE	Electrical and Cable Management Accessories – Cable Management Pole – for 12'(3658mm)-High Ceiling – PLACES Only	.162
HCPS	Electrical and Cable Management Accessories – Cable Management Pole – Panel Height – PLACES Only	.161
HCPS	Electrical and Cable Management Accessories – Cable Management Pole – for 10'(3048mm)-High Ceiling – PLACES Only	.161
HCPS	Electrical and Cable Management Accessories – Cable Management Pole – for 12'(3658mm)-High Ceiling – PLACES Only	.162
HCT-0000	Electrical Components — Hardware / International – Plastic Liner	.169
HCT-0000	PLACES — Electrical Components – Plastic Liner — PLACES Only	.152
HDG-L	Swing Doors with Steel Top Cap – Single Door — Glazed	.130
HDG-R	Swing Doors with Steel Top Cap – Single Door — Glazed	.130
HDPC	Panel Accessories – 90° Finish Post — for Steel Top Cap — Painted Surface	.131
HDPS	Panel Accessories – 180° Finish Post — for Steel Top Cap — Painted Surface	.131
HDS-L	Swing Doors with Steel Top Cap – Single Door — Laminate	.130
HE	Panel Accessories – Hinges	.77

Index

<u>Product Code</u>	<u>Product Description</u>	<u>Page</u>
HE	Panel Accessories – Hinges	107
HFN	Monolithic Fabric Panel with Steel Top Cap — No Power – Fabric	110
HFN-H	High-Performance Monolithic Fabric Panel with Steel Top Cap — No Power – Fabric	118
HFP	Monolithic Fabric Panel with Steel Top Cap — Powered – Fabric	112
HFP-A	Monolithic Fabric Panel with Steel Top Cap — Powered – Fabric	112
HFP-D	Monolithic Fabric Panel with Steel Top Cap — Powered – Fabric	112
HFP-H	High-Performance Monolithic Fabric Panel with Steel Top Cap — Powered – Fabric	120
HFP-H2	High-Performance Monolithic Fabric Panel with Steel Top Cap — Powered – Fabric	120
HFP-H4	High-Performance Monolithic Fabric Panel with Steel Top Cap — Powered – Fabric	120
HGN	Glazed Monolithic Panels with Steel Top Cap — No Power – Glazed	122
HGP	Glazed Monolithic Panels with Steel Top Cap — Powered – Glazed	124
HGP-2	Glazed Monolithic Panels with Steel Top Cap — Powered – Glazed	124
HGP-4	Glazed Monolithic Panels with Steel Top Cap — Powered – Glazed	124
HGRY	Markerboards/Wall Accessory Slat Pad – Wall Accessory Slat Pad	241
HHE	Panel Accessories – Hinges	133
HMN	Basic Monolithic Fabric Panel with Steel Top Cap — No Power – Fabric	114
HMP	Basic Monolithic Fabric Panel with Steel Top Cap — Powered – Fabric	116
HMP-A	Basic Monolithic Fabric Panel with Steel Top Cap — Powered – Fabric	116
HMP-D	Basic Monolithic Fabric Panel with Steel Top Cap — Powered – Fabric	116
HMSC	Mini Shelves with Loop Bracket – Corner Mini-Shelf, with Loop Bracket	222
HMSS	Mini Shelves with Loop Bracket – Straight Mini-Shelf, with Loop Bracket	222
HNAM	Markerboards/Wall Accessory Slat Pad – Markerboard — Non-Magnetic Surface	241
HRE	Panel Accessories – Side Trim Rail With Notch	132
HREH	Full Height Side Trim Rail – for use with Add-On Panels	133
HSCP-V1	Electrical and Cable Management Accessories – Cable Management Post – Variable Height – PLACES Only	163
HSCP-V2	Electrical and Cable Management Accessories – Cable Management Post – Variable Height – Two-Way 90° – PLACES Only	163
HSCP-V3	Electrical and Cable Management Accessories – Cable Management Post – Variable Height — In-Line – PLACES Only	163
HTB	Tack Strips/Tackboards – Tack Strip	239
HTB	Tack Strips/Tackboards – Tackboard	239
HTB-H	Tack Strips/Tackboards – Tack Strip — Monolithic High-Performance Acoustical Panels	240
HTB-H	Tack Strips/Tackboards – Tackboard — Monolithic High-Performance Acoustical Panels	240
HTF-0004	Panel Accessories – Steel Top Cap for 3-Way and 4-Way	132
HTFM	Electrical Components — Hardwire / International – Top Feed Module – Hardwire / International – PLACES Only	169
HTFM	PLACES — Electrical Components – Top Feed Module — PLACES Only	152
HTFM-2	PLACES — Electrical Components – Top Feed Module — PLACES Only	152
HTFM-4	PLACES — Electrical Components – Top Feed Module — PLACES Only	152
HTFM-X	PLACES — Electrical Components – Top Feed Module — PLACES Only	152
KUAF	Wall Mount Components – Tackboard, Wall Mount	238
KUAM	Wall Mount Components – Markerboard, Wall Mount	238
KUP1-0000-CSN	Belong Work Tools Mounting Rails – Tool Rail — Single Post — C-Clamp or Thru-mount	244
KUPY	Wall Mount Components – Slat, Wall Mount	238
KUR1-1224-CSN	Belong Work Tools Mounting Rails – Tool Rail — Worksurface Mount C-Clamp or Thru-Mount	243
(Left-hand swing)	Swing Doors with Steel Top Cap – Single Door — Laminate	104
LUTA	Lighting — Haworth – Adaptable LED Task Light - Add-On Kit	248
LUTD-0017-1NULDN	Lighting — Task – Reed Premier™ Add-On LED Task Light — For Use with Reed Premier Starter LED Task Lights	246
LUTN	Lighting — Haworth – Adaptable LED Task Light - Stand-Alone	247
LUTS-0000	Lighting — Task – Reed Premier™ Add-On Occupancy Sensor	246
LUTS-0017-12ULD6	Lighting — Task – Reed Premier™ Starter LED Task Light	245
LUTS-0017-19ULD5	Lighting — Task – Reed Premier™ Stand-Alone LED Task Light	245
LUTT	Lighting — Haworth – Adaptable LED Task Light - Starter Kit	247
MAC-0001	Worksurface Accessories – Make-A-Corner	220
MEAM	Markerboards/Wall Accessory Slat Pad – Markerboard — Non-Magnetic Surface	241
NADR-8	Shelf Accessories – Adaptable Shelf Dividers	236

Index

Product Code	Product Description	Page
NEP-1	Electrical and Cable Management Accessories – Power Breaker Marker	164
NUB-1	Adaptable Upper Storage – Overhead Storage Unit / Shelf Gang Clip	223
PCC-180-B	Panel Accessories – 180° Power Connector Cover — Radius Profile	106
PCC-180-B	Panel Accessories – 180° Power Connector Cover	132
PCC-90-B	Panel Accessories – 90° Power Connector Cover — Radius Profile	131
PCC-90-B	Panel Accessories – 90° Power Connector Cover	106
PCF-3-B	Electrical Components – Flexible Power Connector — Panel-to-Panel	153
PCF-3-B2	Electrical Components – Flexible Power Connector — Panel-to-Panel	153
PCF-3-B4	Electrical Components – Flexible Power Connector — Panel-to-Panel	153
PCOF-1-B	Electrical Components – Connector Assembly – 12" Pass-Through	154
PCOF-1-B2	Electrical Components – Connector Assembly – 12" Pass-Through	154
PCOF-1-B4	Electrical Components – Connector Assembly – 12" Pass-Through	154
PCSS-3-B	Electrical Components – Flexible Power Connector — Straight Span	154
PCSS-3-B2	Electrical Components – Flexible Power Connector — Straight Span	154
PCSS-3-B4	Electrical Components – Flexible Power Connector — Straight Span	154
PPC-180-B	Panel Accessories – 180° Power Connector Cover	73
PRCN-B	Electrical Components – Ported Raceway Covers	158
PRCP	Electrical Components — Hardwire – Raceway Covers	167
PRCP-B	Electrical Components – Ported Raceway Covers	158
PRD-1500-I	Electrical Components – Duplex Receptacle – 15 Amp	155
PRD-1500-M	Electrical Components – Duplex Receptacle – 15 Amp	155
PRD-2000-M12	Electrical Components – Duplex Receptacle – 20 Amp	157
PRD-2000-M13	Electrical Components – Duplex Receptacle – 20 Amp	157
PRD-3-B	Electrical Components – Duplex Receptacle – 15 Amp	155
PRDI-5-B	Electrical Components – Duplex Receptacle – 15 Amp	155
RKN-B	Electrical Components – Raceway Retrofit Kit	156
RKP-00-C	Electrical Components — Hardwire – Dual Power Access Raceway Kit — 4"-High Base Raceway	167
RKP-3-LB	Electrical Components – Raceway Cover – 20 Amp	157
RKP-3-LS	Electrical Components – Raceway Cover – 20 Amp	157
RKP-B	Electrical Components – Raceway Retrofit Kit	156
RKP-B2	Electrical Components – Raceway Retrofit Kit	156
RKP-B4	Electrical Components – Raceway Retrofit Kit	156
SPCL-1613	Clerestory Kits – 2-Way Connector Kit	144
SPCL-1614	Clerestory Kits – 3-Way Connector Kit	144
SPCL-1615	Clerestory Kits – 4-Way Connector Kit	144
SPCL-1616	Clerestory Kits – Straight Track Kit	144
SPCL-1622	Clerestory Kits – End Kit	144
SRE	Panel Accessories – Side Trim Rail	76
SRE	Panel Accessories – Side Trim Rail	107
SREH	Panel Accessories – Full Height Side Trim Rail	76
SREH	Panel Accessories – Full-Height Side Trim Rails — for use with Add-On Panels	107
TFM-B	Electrical Components – Top Feed Module — UniGroup Only	151
TFM-B2	Electrical Components – Top Feed Module — UniGroup Only	151
TFM-B4	Electrical Components – Top Feed Module — UniGroup Only	151
TFM-NT	Electrical Components — Hardwire / International – Top Feed Module – Hardwire / International – UniGroup Only	168
TFM-X	Electrical Components – Top Feed Module — UniGroup Only	151
TMKT-B	Panel Accessories – T-Mount Kit — Center and End Conditions	108
U2FA	Panel Accessories – Retrofit Kits – 120° Full-Height Finish Post — Square Painted Top Cap	138
U2FA-V	Panel Accessories – Retrofit Kits – 120° Variable-Height Finish Post — Square Painted Top Cap	138
U2FS	Panel Accessories – Retrofit Kits – 180° Full-Height Finish Post — Square Painted Top Cap	139
U2FS-V	Panel Accessories – Retrofit Kits – 180° Variable-Height Finish Post — Square Painted Top Cap	139
U2PA	Panel Accessories – Retrofit Kits – 120° Full-Height Finish Post — Square Painted Top Cap	138
U2PA-V	Panel Accessories – Retrofit Kits – 120° Variable-Height Finish Post — Square Painted Top Cap	138

Index

<u>Product Code</u>	<u>Product Description</u>	<u>Page</u>
U2PC	Panel Accessories – Retrofit Kits – 90° Full-Height Finish Post — Square Painted Top Cap	137
U2PC-V	Panel Accessories – Retrofit Kits – 90° Variable-Height Finish Post — Square Painted Top Cap	137
U2PS	Panel Accessories – Retrofit Kits – 180° Full-Height Finish Post — Square Painted Top Cap	139
U2PS-V	Panel Accessories – Retrofit Kits – 180° Variable-Height Finish Post — Square Painted Top Cap	139
UEFF-QM	Adaptable Upper Storage – Overhead Storage Unit, Standard Mount – Translucent Door	225
UEFS-LM	Adaptable Upper Storage – Overhead Storage Unit, Standard Mount – Laminate Door	227
UEFS-PM	Adaptable Upper Storage – Overhead Storage Unit, Standard Mount – Painted Door	224
UEFS-WM	Adaptable Upper Storage – Overhead Storage Unit, Standard Mount – Wood Door	226
UEGF-QM	Adaptable Upper Storage – Overhead Storage Unit, Up Mount – Translucent Door	229
UEGS-LM	Adaptable Upper Storage – Overhead Storage Unit, Up Mount – Laminate Door	231
UEGS-PM	Adaptable Upper Storage – Overhead Storage Unit, Up Mount – Painted Door	228
UEGS-WM	Adaptable Upper Storage – Overhead Storage Unit, Up Mount – Wood Door	230
UEHF-QM	Adaptable Upper Storage – Overhead Storage Unit, Standard Mount – Translucent Door	225
UEHS-LM	Adaptable Upper Storage – Overhead Storage Unit, Standard Mount – Laminate Door	227
UEHS-PM	Adaptable Upper Storage – Overhead Storage Unit, Standard Mount – Painted Door	224
UEHS-WM	Adaptable Upper Storage – Overhead Storage Unit, Standard Mount – Wood Door	226
UEJF-QM	Adaptable Upper Storage – Overhead Storage Unit, Up Mount – Translucent Door	229
UEJS-LM	Adaptable Upper Storage – Overhead Storage Unit, Up Mount – Laminate Door	231
UEJS-PM	Adaptable Upper Storage – Overhead Storage Unit, Up Mount – Painted Door	228
UEJS-WM	Adaptable Upper Storage – Overhead Storage Unit, Up Mount – Wood Door	230
UEKF-QM	Adaptable Upper Storage – Overhead Storage Unit, Standard Mount – Translucent Door	225
UEKS-LM	Adaptable Upper Storage – Overhead Storage Unit, Standard Mount – Laminate Door	227
UEKS-PM	Adaptable Upper Storage – Overhead Storage Unit, Standard Mount – Painted Door	224
UEKS-WM	Adaptable Upper Storage – Overhead Storage Unit, Standard Mount – Wood Door	226
UELF-QM	Adaptable Upper Storage – Overhead Storage Unit, Up Mount – Translucent Door	229
UELS-LM	Adaptable Upper Storage – Overhead Storage Unit, Up Mount – Laminate Door	231
UELS-PM	Adaptable Upper Storage – Overhead Storage Unit, Up Mount – Painted Door	228
UELS-WM	Adaptable Upper Storage – Overhead Storage Unit, Up Mount – Wood Door	230
UESN-PM	Adaptable Upper Storage – Open Shelf, Standard Mount	223
UESY-PM	Adaptable Upper Storage – Straight Mini Shelf, Standard Mount	221
UESZ-PM	Adaptable Upper Storage – Corner Mini Shelf, Standard Mount	221
UUFB-P	Wall Mount Components – Back for Wall Mounted Overhead Storage Unit	237
UUFF-QW	Wall Mount Components – Overhead Storage Unit, Wall Mount – Translucent Door	233
UUFF-LW	Wall Mount Components – Overhead Storage Unit, Wall Mount – Laminate Door	235
UUFF-PW	Wall Mount Components – Overhead Storage Unit, Wall Mount – Painted Door	232
UUFF-WW	Wall Mount Components – Overhead Storage Unit, Wall Mount – Wood Door	234
UUHF-QW	Wall Mount Components – Overhead Storage Unit, Wall Mount – Translucent Door	233
UUHS-LW	Wall Mount Components – Overhead Storage Unit, Wall Mount – Laminate Door	235
UUHS-PW	Wall Mount Components – Overhead Storage Unit, Wall Mount – Painted Door	232
UUHS-WW	Wall Mount Components – Overhead Storage Unit, Wall Mount – Wood Door	234
UUKF-QW	Wall Mount Components – Overhead Storage Unit, Wall Mount – Translucent Door	233
UUKS-LW	Wall Mount Components – Overhead Storage Unit, Wall Mount – Laminate Door	235
UUKS-PW	Wall Mount Components – Overhead Storage Unit, Wall Mount – Painted Door	232
UUKS-WW	Wall Mount Components – Overhead Storage Unit, Wall Mount – Wood Door	234
VEEH-2	Electrical Components – Infeed Harness	149
VEEH-3	Electrical Components – Infeed Harness	149
VEEH-4	Electrical Components – Infeed Harness	149
VEZP	Panel Accessories – Filler Post - Sliding Door	68
VUZF	Panel Accessories – Sliding Door	68
WMK	Panel Accessories – Wall Mount Kit	77
WMK	Panel Accessories – Wall Mount Kit	108
WMK	Panel Accessories – Wall Mount Kit	134
WT	Panel Accessories – Wall Track	77

Index

<u>Product Code</u>	<u>Product Description</u>	<u>Page</u>
WT	Panel Accessories – Wall Track	108
WT	Panel Accessories – Wall Track	134
WT	Shelf Accessories – Wall Track	236
WUCA	Adaptable Worksurfaces – Corner, 90° Straight Front	183
WUCB-L54	Adaptable Worksurfaces – Bent	207
WUCB-R45	Adaptable Worksurfaces – Bent	207
WUCC-0004	Worksurface Supports – Support Column	218
WUCD-L	Adaptable Worksurfaces – D-Shaped Convergent, Wrap-Around	204
WUCE-L44	Adaptable Worksurfaces – Corner, 90° Wrap-Around Extended	192
WUCE-R44	Adaptable Worksurfaces – Corner, 90° Wrap-Around Extended	192
WUCF-L45	Adaptable Worksurfaces – Corner, 90° Angled – Transitional	190
WUCF-L54	Adaptable Worksurfaces – Corner, 90° Angled – Transitional	190
WUCH-N34	Adaptable Worksurfaces – Corner, 90° Notched Transitional	189
WUCH-N43	Adaptable Worksurfaces – Corner, 90° Notched Transitional	189
WUCL-0001	Worksurface Supports – Straight Leg Basic	218
WUCN	Adaptable Worksurfaces – Corner, 90° Notched	185
WUCN	Adaptable Worksurfaces – Corner 90° Worksurface	187
WUCP-L44	Adaptable Worksurfaces – Corner, 90° Notched Extended	194
WUCP-R44	Adaptable Worksurfaces – Corner, 90° Notched Extended	194
WUCQ-N44	Adaptable Worksurfaces – 90° Merger	200
WUCR	Adaptable Worksurfaces – Corner, 90° Wrap-Around	184
WUCT-N34	Adaptable Worksurfaces – Corner, 90° Wrap-Around Transitional	188
WUCT-N43	Adaptable Worksurfaces – Corner, 90° Wrap-Around Transitional	188
WUCU	Adaptable Worksurfaces – Corner, 90° Angled	186
WUCX-L43	Adaptable Worksurfaces – Corner, 90° Wrap-Around Transitional Extended	197
WUCX-R34	Adaptable Worksurfaces – Corner, 90° Wrap-Around Transitional Extended	197
WUCZ-N44	Adaptable Worksurfaces – Corner, 120° Wrap-Around	201
WUDC-3830	Adaptable Worksurfaces – Conference End	209
WUDC-5030	Adaptable Worksurfaces – Conference End	209
WUDC-6230	Adaptable Worksurfaces – Conference End	209
WUDD	Adaptable Worksurfaces – D-Shaped Ender	206
WUDZ	Adaptable Worksurfaces – 120° Link	211
WUKC	Adaptable Worksurfaces – Corner 90° Adjustable Split Top	187
WUKR	Adaptable Worksurfaces – Rectangular Adjustable Split Top	174
WURA	Adaptable Worksurfaces – Rectangular Worksurface	174
WURA	Adaptable Worksurfaces – Rectangular	171
WURD	Adaptable Worksurfaces – D-Shaped Convergent	202
WURE-N34	Adaptable Worksurfaces – Wedge	179
WURE-N43	Adaptable Worksurfaces – Wedge	179
WURG-N34	Adaptable Worksurfaces – Sharp Wedge	181
WURG-N43	Adaptable Worksurfaces – Sharp Wedge	181
WURR	Adaptable Worksurfaces – Rectangular Radius End	182
WURS	Adaptable Worksurfaces – Rectangular Swell	176
WURT-N34	Adaptable Worksurfaces – Rectangular Transition	178
WURT-N43	Adaptable Worksurfaces – Rectangular Transition	178
WURV	Adaptable Worksurfaces – Rectangular Convergent	203
WURW	Adaptable Worksurfaces – Rectangular Inverse Swell	177
WURY	Adaptable Worksurfaces – Rectangular Key	175
WURY-3830	Adaptable Worksurfaces – Key Conference End	210
WURY-5030	Adaptable Worksurfaces – Key Conference End	210
WURY-5036	Adaptable Worksurfaces – Key Conference End	210
WURY-6236	Adaptable Worksurfaces – Key Conference End	210
WURY-6242	Adaptable Worksurfaces – Key Conference End	210

Index

Product Code	Product Description	Page
WURY-6248	Adaptable Worksurfaces – Key Conference End	210
WUTS	Adaptable Worksurfaces – Countertop	208
Z2BT-0000	Worksurface Supports – Counter Top Brackets	215
ZEBA-0000	Worksurface Supports – Side Bracket	215
ZEBC-1200	Worksurface Supports – Standard Snap-n-Fit Mini Cantilever Bracket for Corner Worksurface	214
ZEBC-1900	Worksurface Supports – Standard Snap-n-Fit Cantilever Bracket for Corner Worksurface	214
ZEBD-1000	Worksurface Supports – Standard Mini Cantilever Bracket	212
ZEBD-1600	Worksurface Supports – Standard Cantilever Bracket	212
ZEBF-0000-P	Worksurface Supports – Anti Dislodgement Bracket for use with Worksurface Support Panels	214
ZEBL-1600	Worksurface Supports – Standard Link Cantilever Bracket	212
ZEBN-0000	Adaptable Worksurface Supports – Pedestal-to-Panel Bracket	216
ZEBR-0000	Worksurface Supports – Rear-Corner Bracket	215
ZEBS-1200	Worksurface Supports – Standard Snap-n-Fit Mini Cantilever Bracket for Rectangular Worksurfaces	213
ZEBS-1900	Worksurface Supports – Standard Snap-n-Fit Cantilever Bracket for Rectangular Worksurfaces	213
ZEBT-0000	Worksurface Supports – Counter Top Brackets	215
ZEBV-0000	Worksurface Supports – Convergent Mount Bracket	215
ZEFS	Adaptable Worksurface Supports – Worksurface Support Panels	217
ZEFS	Adaptable Worksurface Supports – Worksurface Support Panels	217
ZHBT-0000	Worksurface Supports – Counter Top Brackets	215
ZUBF-0000	Worksurface Supports – Flush Mount Plate	215
ZUBW-PN	Wall Mount Components – Worksurface Wall Bracket	237
ZUFJ-0101-PNFG	Worksurface Supports – Single Support Leg	219
ZZFJ	Worksurface Supports – Support Post	219
ZZFK	Worksurface Supports – Double Support Leg	219

Product Compatibility and Limited Warranty Policy

Great Expectations

You have them as a Haworth customer and so do we. And because we value our customers, we cover our products with the Haworth North America Product Compatibility and Limited Warranty Policy.

Our Commitment To Product Compatibility – Integrated Product Platforms

As a market leader in the design and manufacture of workspaces that adapt to change, we strive to maintain product compatibility within our various generations of integrated product platforms. This benefits the customer who desires to update or modify their work environment. It also benefits the customer needing to replace a product due to damage or other reasons but which is no longer manufactured or is otherwise unavailable, such as a fabric or finish that is discontinued because of changing market preferences. In both circumstances, we often can provide products with comparable function and performance.

Our Commitment To Product Quality – The Haworth North America Limited Warranty

To ensure customer satisfaction and peace of mind, we stand behind our products with the Haworth North America Limited Warranty. To review the current version of the limited warranty including its terms and conditions, please go to:

www.haworth.com/warranty or contact OneTouch@Haworth.com or 1 877 429 6784.

Warranty Requests or Questions

For questions or service requests pertaining to the Haworth Limited Warranty, please contact your Haworth dealer.

If you are unsure who your dealer is, please contact **OneTouch@Haworth.com or 1 877 429 6784.**

Effective: September 1, 2021

Terms of Sale

The Terms of Sale apply to all products in the North America Price Lists. To review the current version of the North American Terms of Sale, please go to:

www.haworth.com/terms-of-sale or contact OneTouch@Haworth.com or 1 877 429 6784.

Effective: September 2, 2022

HAWORTH®

HAWORTH® is a registered trademark of Haworth, Inc.
© Haworth, Inc. All rights reserved. 2024 2.24 | Item #LIT21026
haworth.com | 800 344 2600