

HAWORTH

# Masters Series

North America Price List – February 2024





**This Haworth North American price book contains US list prices.**

Canadian customers can convert the US list price into their Canadian equivalent by going to [www.Haworth.com/Canada](http://www.Haworth.com/Canada) to find the current Canadian multipliers. These multiplier factors allow you to convert the US list price into a Canadian list price.

# Price List Overview

The following overview explains how information is organized within the Masters Series® price list.

- 1 Front Cover**
  - Includes the price book title and pricing effectivity date.
- 2 Canadian Conversion / Update Page**
  - Pricing conversion information for converting US pricing into the equivalent Canadian pricing is located on the footer of this page.
  - All Price Book updates will be listed on this page including the date, page number and description of the update.
- 3 Price List Table of Contents**
  - Price List table of contents with page numbers.
- 4 Statement of Line**
  - Provides a pictorial outline of the entire product offering.
- 5 Price List**

Each price list page contains the following:

  - Product Illustration
  - Catalog Number
  - To Order Specify – sequencing for ordering product options and finishes
  - List Prices
  - Product Specification Dimensions
  - Features
  - Specification Tips
  - Class, Discount Group Number (used for discounting) and GSA information
- 6 Finishes, Fabrics and COM**
  - Lists information for material finishes and availability.
  - Provides COM information and requirements (if applicable).
- 7 Index**
  - Products are listed alphabetically by alpha-numeric catalog numbers with price list page number.
- 8 Warranty Policy and Terms of Sale**
  - Provides information about the Haworth policy for non-obsolescence, warranty and Terms-of-Sale.

## Additional Information and Resources

Prices are subject to change without notice or approval. Haworth dealers should always submit proposals through Lynx before presenting to customers. See North American Terms of Sale for more information.

### Online Resources

#### haworth.com

- Haworth's corporate website provides access to price books and a variety of other resources and publications.

#### surfaces.haworth.com

- Website provides access to the most current fabrics and finishes offered across Haworth's various product lines.

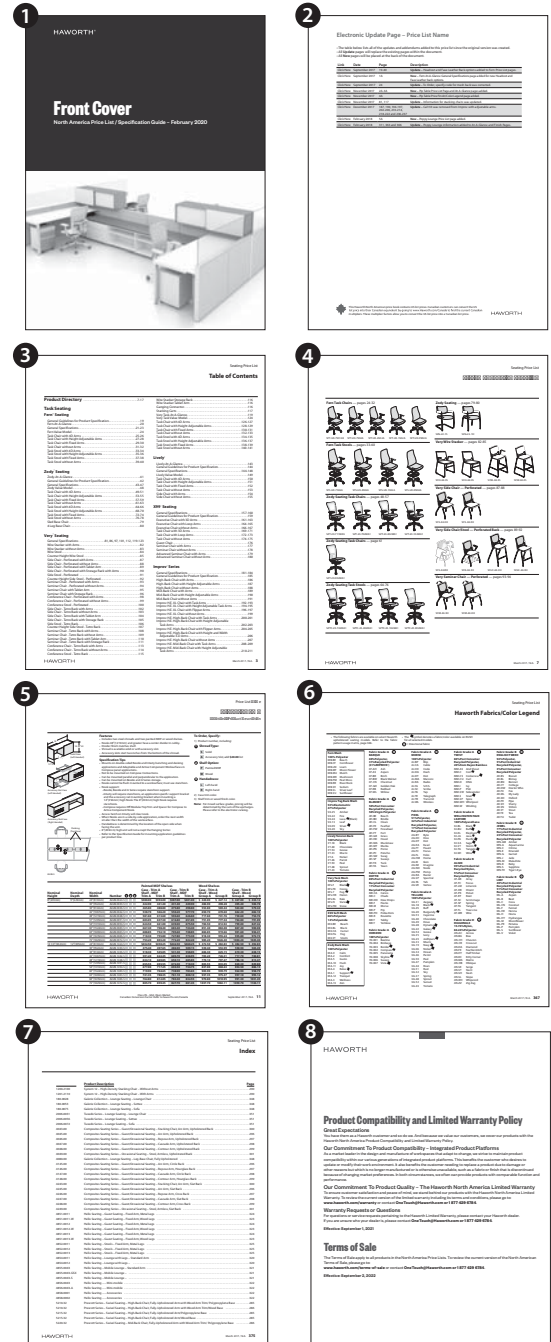

# Table of Contents

<b>Statement of Line</b> .....	7-16	Tackboards — Vertical Storage Units — Fabric .....	90
<b>Product Catalog Number Code</b> .....	17	Tackboards — Vertical Storage Units — Fabric and Slat Rail .....	90
<b>Desks</b>		Open Sided Shelf .....	92
Single Pedestal Rectangular Top Desk with Full Overlay Modesty .....	18	Overhead Storage Units — 1H Open .....	94
Single Pedestal Bow Top Desk with Full Overlay Modesty .....	19	Overhead Storage Units — 2H Open .....	96
Single Pedestal Rectangular Top Desk with Inset Modesty .....	20	Overhead Storage Units — 1H with Hinged Doors .....	98
Single Pedestal Bow Top Desk with Inset Modesty .....	21	Overhead Storage Units — 1.5H with Hinged Doors .....	100
Double Pedestal Rectangular Top Desk with Full Overlay Modesty .....	22	Overhead Storage Units — 2H with Hinged Doors .....	102
Double Pedestal Bow Top Desk with Full Overlay Modesty .....	23	Overhead Storage Units — 1H with Sliding Door .....	104
Double Pedestal Rectangular Top Desk with Inset Modesty .....	24	Overhead Storage Units — 1.5H with Sliding Door .....	106
Double Pedestal Bow Top Desk with Inset Modesty .....	25	Overhead Storage Units — 2H with Sliding Door .....	108
Shell — Rectangular Top Desk .....	26	Overhead Storage Units — 1H with Glass Hinged Doors .....	110
Shell — Bow Top Desk .....	27	Overhead Storage Units — 1.5H with Glass Hinged Doors .....	112
Table Desk — Rectangular — Hoop Leg .....	28	Overhead Storage Units — 2H with Glass Hinged Doors .....	114
Height Adjustable Table Desk — Rectangular Top — T-Leg Base .....	30	Overhead Storage Units — 1H with Glass Sliding Door .....	116
Height Adjustable Convergent Worktop — T-Leg — Rectangular .....	32	Overhead Storage Units — 1.5H with Glass Sliding Door .....	118
Height Adjustable Convergent Worktop — T-Leg — Wedge Square .....	34	Overhead Storage Units — 2H with Glass Sliding Door .....	120
Height Adjustable Convergent Worktop — T-Leg — Wedge Radius .....	36	Mounting Bracket Masters Overhead Storage Unit to Enclose ..	122
Convergent Worktop for use with 1.5H Storage — Rectangular with Column or Hoop .....	38	<b>Tackboards</b>	
Convergent Worktop for use with 1.5H Storage — Wedge Square with Column or Hoop .....	39	Tackboards — Wall Mount Overhead Storage Units — Fabric ...	123
Convergent Worktop for use with 1.5H Storage — Wedge Radius with Column or Hoop .....	40	Tackboards — Wall Mount Overhead Storage Units — Fabric and Slat Rail .....	123
Shroud for use with Height Adjustable T-Leg .....	41	Fabric Tackboards .....	124
Modesty Panel for Shroud .....	42	Fabric and Slat Rail .....	124
Convergent T-Worktop — Rectangular .....	43	<b>Stack-On Storage</b>	
Convergent D-Worktop with T-Support and Column .....	45	Stack-On Bookcase .....	125
Convergent P-Worktop with T-Support and Column .....	47	Stack-On Storage Cabinet with Hinged Doors .....	126
Convergent D-Worktop with Column .....	49	Stack-On Storage Cabinet with Glass Doors .....	127
Convergent P-Worktop with Column .....	50	<b>Reception Stations</b>	
Full Wedge Square Convergent Worktop with Column .....	51	L-Shaped Reception Station .....	128
Full Wedge Square Convergent Worktop with Column and Stanchions .....	51	U-Shaped Reception Station .....	129
Full Wedge Square Slip Fit Convergent Worktop with Column ..	52	Tackboards — Reception Station L-Shaped and U-Shaped .....	129
Half Wedge Square Convergent Worktop with Column .....	53	<b>Modular Components</b>	
Half Wedge Square Convergent Worktop with Column and Stanchions .....	54	Common Storage Top with Two Profiled Edges .....	130
Half Wedge Square Slip Fit Convergent Worktop .....	55	Modular Component — Credenza Top .....	131
Bridge .....	57	Full Overlay Modesty Panel .....	134
Shell — Corner .....	59	Hinged Modesty Panel .....	135
Return Top .....	60	Adaptable Modesty Panel .....	136
Return with Pedestal .....	61	Modular Components — End Panel — 2H .....	138
Return with 30" Wide Lateral File .....	62	Modular Components — L-Support Panel .....	140
Credenza with Pedestals .....	63	Modular Components — Partial Depth L-Support Panel — 2H ..	142
Height Adjustable Credenza Desk — Rectangular — T-Leg Base ..	65	Modular Components — T-Support Panel .....	143
Credenza with Pedestals and Closed Storage .....	67	Modular Components — T-Support Panel — 2H .....	144
Credenza with 36" Wide Lateral Files .....	68	Modular Components — Mid-Support Panel — 2H .....	144
Credenza with 30" Wide Lateral Files and Kneespace .....	69	<b>Storage</b>	
<b>Upper Storage</b>		Attached Pedestals .....	145
Vertical Storage Unit — 1H Open .....	70	Mobile Pedestal .....	146
Vertical Storage Unit — 2H Open .....	72	Storage Cushion .....	147
Vertical Storage Unit — 1H with Hinged Doors .....	74	1.5H Attached Lateral File with Open Shelf .....	148
Vertical Storage Unit — 2H with Hinged Doors .....	76	1H and 1.5H High and 2H Attached Lateral Files .....	150
Vertical Storage Unit — 1H with Sliding Door .....	78	1H and 2H Attached Storage Units .....	152
Vertical Storage Unit — 2H with Sliding Door .....	80	1.5H Attached Storage for use with Convergent Worktop — Open Unit .....	154
Vertical Storage Unit — 1H with Glass Hinged Doors .....	82	2H Storage Unit with Doors .....	155
Vertical Storage Unit — 2H with Glass Hinged Doors .....	84	1.5H Attached Sliding Door Storage Unit .....	156
Vertical Storage Unit — 1H with Glass Sliding Door .....	86	2H Attached Sliding Door Storage Unit .....	158
Vertical Storage Unit — 2H with Glass Sliding Door .....	88	1.5H Attached Sliding Door Storage Unit for use with Convergent Worktop .....	160
		2H Attached Sliding Door Storage Unit .....	162
		3H Open Storage Unit .....	164
		3H Freestanding Storage Unit with Hinged Doors .....	165
		Freestanding Lateral File — 3H and 4H .....	166
		Freestanding Lateral File — 5H and 6H .....	167

# Table of Contents

---

Combination Unit — 5H and 6H .....	168
Wardrobe with Open Unit — 5H and 6H .....	169
Wardrobe with Closed Storage Unit — 5H and 6H .....	170
Personal Storage Tower with F/F/F and Valet .....	171
Personal Storage Tower with F/F Pedestal and Valet — 5H and 6H .....	172
Storage Tower — 5H and 6H .....	173
Freestanding Wardrobe Tower — 5H and 6H .....	174
Bookcase — 2H, 3H, 4H, 5H and 6H .....	176
<b>Tables &amp; Presentation Board</b>	
Table — Round .....	178
Square Tables .....	178
<b>Accessories</b>	
Counterweight .....	179
Flush Mount Plate .....	179
Tetra Bracket .....	179
Center Drawer .....	180
Pencil Tray .....	180
File Bars .....	180
Grommet .....	181
Column Base .....	181
<b>Finishes and Fabrics</b>	
Finish Matrix .....	182-184
Fabrics/Color Legend .....	185
<b>Customer's Own Material</b>	
COM Yardage Requirements .....	186-187
<b>Index</b> .....	188-194
<b>Lifetime Product Warranty</b> .....	Inside Back Cover

This page intentionally blank

# Statement of Line

## Desks — pages 18-69

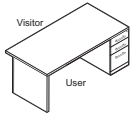

XLSP-LF  
XZSF-WF  
**Single Pedestal  
Rectangular Top Desk  
with Full Overlay**

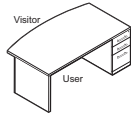

XLSP-LB  
XZSF-WB  
**Single Pedestal Bow  
Top Desk with Full  
Overlay Modesty**

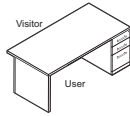

XLSP-LF  
XZSP-WF  
**Single Pedestal  
Rectangular Top Desk  
with Inset Modesty**

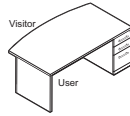

XLSP-LB  
XZSP-WB  
**Single Pedestal Bow  
Top Desk with Inset  
Modesty**

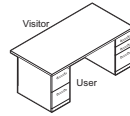

XLDF-LF  
XZDF-WF  
**Double Pedestal  
Rectangular Top Desk  
with Full Overlay  
Modesty**

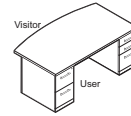

XLDF-LB  
XZDF-WB  
**Double Pedestal Bow  
Top Desk with Full  
Overlay Modesty**

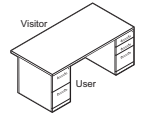

XLDH-LF  
XZDH-WF  
**Double Pedestal  
Rectangular Top Desk  
with Inset Modesty**

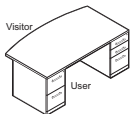
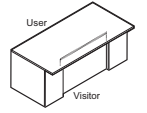
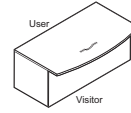
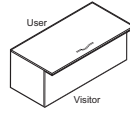
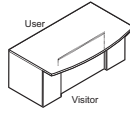
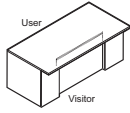
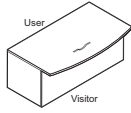
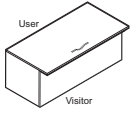

XLDH-LB  
XZDH-WB  
**Double Pedestal Bow  
Top Desk with Inset  
Modesty**

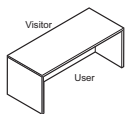

XLYH-SF  
XZYL-SF  
**Shell — Rectangular  
Top Desk**

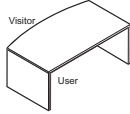

XLYH-SB  
XZYL-SB  
**Shell — Bow Top Desk**



XLAR-3072  
XZAR-3072  
**Table Desk —  
Rectangular —  
Hoop Leg**

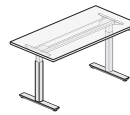

XLAR-3060  
XZAR-3060  
**Height Adjustable  
Table Desk —  
Rectangular Top —  
T-Leg Base**

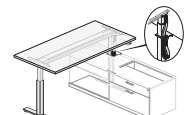

XLNR-3060  
XZNR-3060  
**Height Adjustable  
Convergent  
Worktop — T-Leg —  
Rectangular**

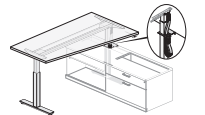

XLNW-4260  
XZNW-4260  
**Height Adjustable  
Convergent  
Worktop — T-Leg —  
Wedge Square**

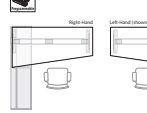
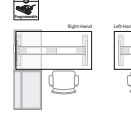
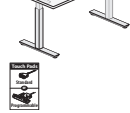
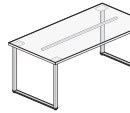
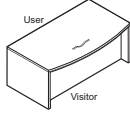
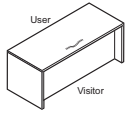
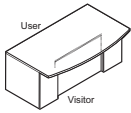

XLNG-4260  
XZNG-4260  
**Height Adjustable  
Convergent  
Worktop — T-Leg —  
Wedge Radius**

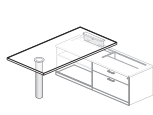

XLNR-3072  
XZNR-3072  
**Convergent Worktop  
for use with 1.5H  
Storage —  
Rectangular with  
Column or Hoop**

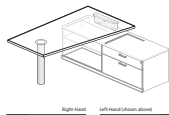

XLNW-4272  
XZNW-4272  
**Convergent Worktop  
for use with 1.5H  
Storage — Wedge  
Square with Column  
or Hoop**

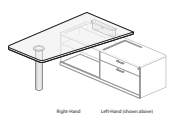

XLNG-4272  
XZNG-4272  
**Convergent Worktop  
for use with 1.5H  
Storage — Wedge  
Radius with Column  
or Hoop**

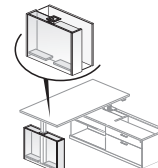

XLS1-3060  
XZS1-3060  
**Shroud for use with  
Height Adjustable  
T-Leg**

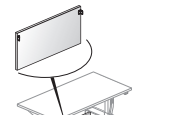

XLXS-2260  
XZXS-2260  
**Modesty Panel  
for Shroud**

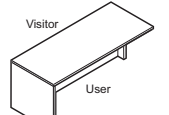

XLTH-FL  
XZTH-FL  
**Convergent  
T-Worktop —  
Rectangular**

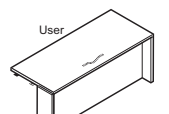
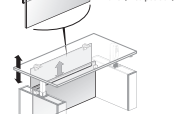
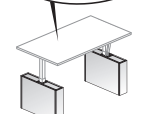
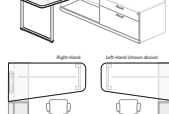
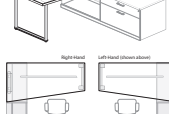
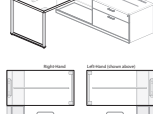
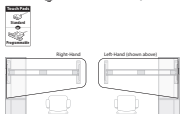
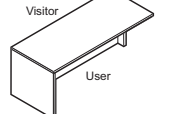
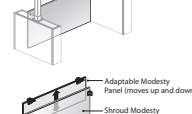
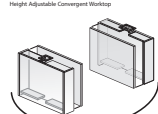
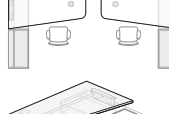
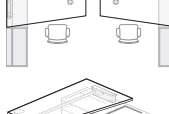
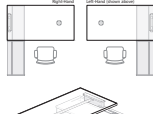
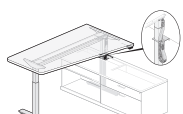

# Statement of Line

## Desks (cont'd) — pages 18-69

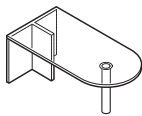

XLXD-SF  
XZXD-SF  
**Convergent  
D-Worktop with  
T-Support and Column**

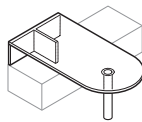

XLXD-SP  
XZXD-SP  
**Convergent  
D-Worktop with  
T-Support and Column**

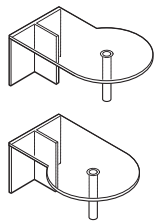

XLXP-SF  
XZXP-SF  
**Convergent  
P-Worktop with  
T-Support and Column**

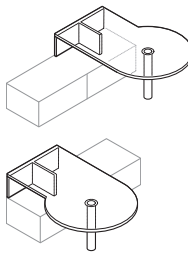

XLXP-SP  
XZXP-SP  
**Convergent  
P-Worktop with  
T-Support and Column**

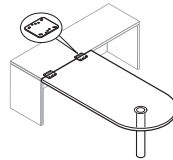

XLND-NS  
XZND-NS  
**Convergent  
D-Worktop with  
Column**

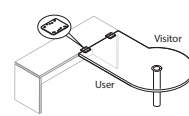

XLNP-RS  
XTNP-RS  
XZNP-RS  
**Convergent  
P-Worktop with  
Column**

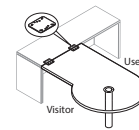

XLNP-LS  
XZNP-LS  
**Convergent  
P-Worktop with  
Column**

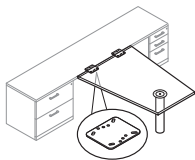

XLNY-YC  
XZNY-YC  
**Full Wedge Square  
Convergent Worktop  
with Column**

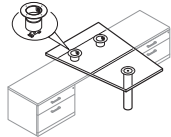

XLNY-NB  
XZNY-NB  
**Full Wedge Square  
Convergent Worktop  
with Column and  
Stanchions**

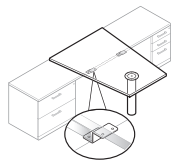

XLNY-NS  
XZNY-NS  
**Full Wedge Square  
Slip Fit Convergent  
Worktop with Column**

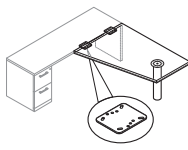

XLNZ-YC  
XZNZ-YC  
**Half Wedge Square  
Convergent Worktop  
with Column**

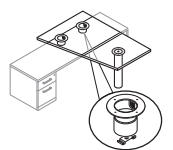

XLNZ-NB  
XZNZ-NB  
**Half Wedge Square  
Convergent Worktop  
with Column and  
Stanchions**

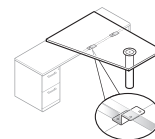

XLNZ-NS  
XZNZ-NS  
**Half Wedge Square  
Slip Fit Convergent  
Worktop**

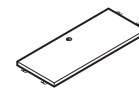

XLBF-NS  
XZBF-NS  
**Bridge**

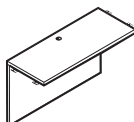

XLBF-FS  
XZBF-FS  
**Bridge**

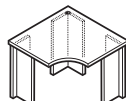

XLCN-22  
XZCN-22  
**Shell — Corner**

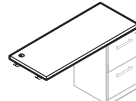

XLBR-SR  
XZBR-SR  
**Return Top**

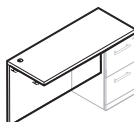

XLBR-SR  
XZBR-SR  
**Return Top**

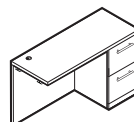

XLRP-RS  
XZRP-RS  
**Return with Pedestal**

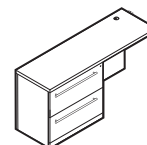

XLRL-LS  
XZRL-LS  
**Return with 30" Wide  
Lateral File**

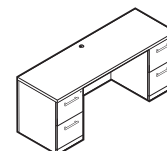

XZZP-BY  
XZBF-NS  
**Credenzas with  
Pedestals**



# Statement of Line

## Desks (cont'd) — pages 18-69

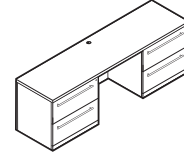
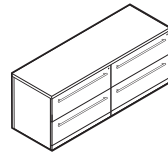
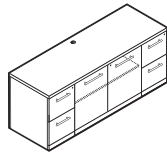
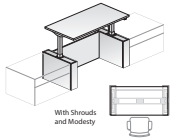
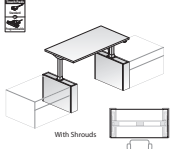
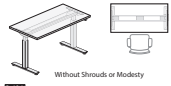

XLZR-2460  
XZZR-2460  
**Height Adjustable Credenza Desk — Rectangular - T-Leg Base**

XZZS-YL  
**Credenza with Pedestals and Closed Storage**

XZZL-BN  
**Credenza with 36" Wide Lateral Files**

XZZM-BY  
**Credenza with 30" Wide Lateral Files and Kneespace**

## Upper Storage — pages 70-122

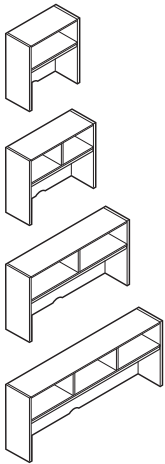

X4UL-NN  
X4UD-NN  
X5UL-NN  
X5UD-NN  
**Vertical Storage Unit — 1H Open**

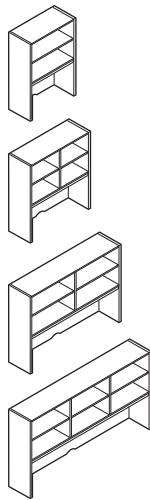

X4UL-NN  
X4UD-NN  
X5UL-NN  
X5UD-NN  
**Vertical Storage Unit — 2H Open**

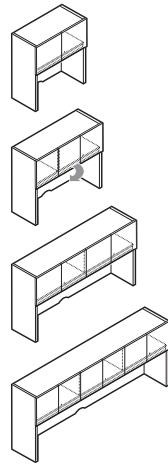

X4VL-NW  
X4VD-NW  
X5VL-NL  
X5VD-NL  
**Vertical Storage Unit — 1H with Hinged Doors**

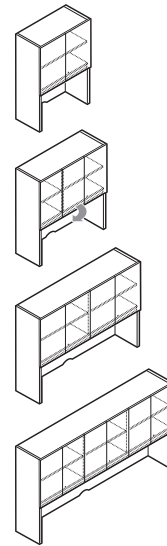

X4VL-LW  
X4VD-LW  
X5VL-LL  
X5VD-LL  
**Vertical Storage Unit — 2H with Hinged Doors**

# Statement of Line

## Upper Storage (cont'd) — pages 70-122

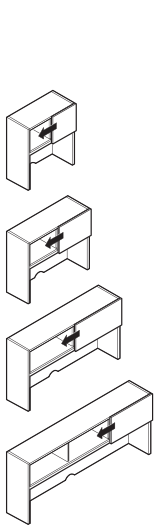

X4RL-NW  
X4RD-NW  
X5RL-NL  
X5RD-NL  
**Vertical Storage Unit — 1H with Sliding Door**

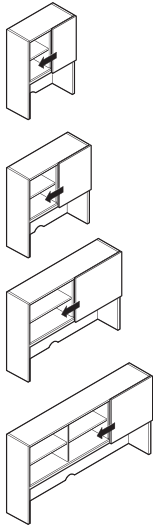

X4RL-NW  
X4RD-NW  
X5RL-NL  
X5RD-NL  
**Vertical Storage Unit — 2H with Sliding Door**

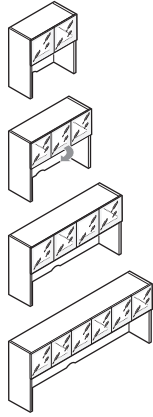

X4SL-NT  
X4SD-NT  
X5SL-NT  
X5SD-NT  
**Vertical Storage Unit — 1H with Glass Hinged Doors**

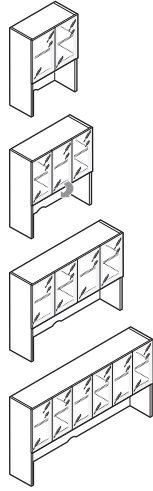

X4SL-LT  
X4SD-LT  
X5SL-LT  
X5SD-LT  
**Vertical Storage Unit — 2H with Glass Hinged Doors**

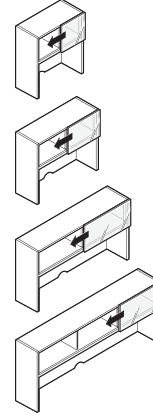

X4LL-NT  
X4LD-NT  
X5LL-NT  
X5LD-NT  
**Vertical Storage Unit — 1H with Glass Sliding Door**

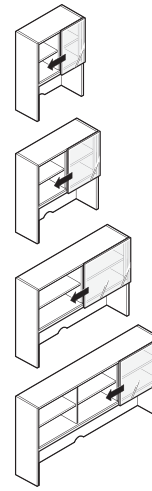

X4LL-NT  
X4LD-NT  
X5LL-NT  
X5LD-NT  
**Vertical Storage Unit — 2H with Glass Sliding Door**

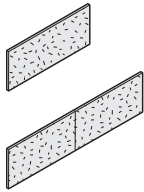

MTVD  
**Tackboards — Vertical Storage Units — Fabric**

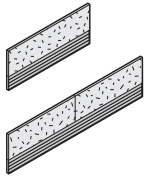

MTSV  
**Tackboards — Vertical Storage Units — Fabric and Slat Rail**

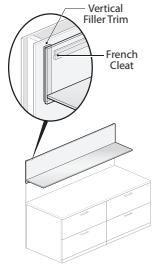

ULWL-1730-NSN  
ULWD-1730-NSN  
**Open Sided Shelf — 1H and 2H**



ULWL-2930-NSN  
ULWD-2930-NSN  
**Open Sided Shelf — 1H and 2H**

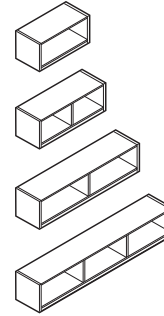

ULNL-SN  
ULND-SN  
UXNL-SN  
UXND-SN  
**Overhead Storage Units — 1H Open**

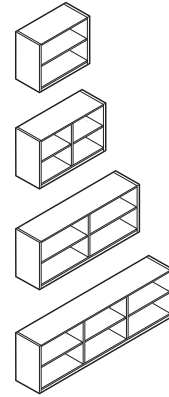

ULNL-SN  
ULND-SN  
UXNL-SN  
UXND-SN  
**Overhead Storage Units — 2H Open**

# Statement of Line

## Upper Storage (cont'd) — pages 70-122

<p>ULOL-SN ULOD-SN UXOL-SN UXOD-SN <b>Overhead Storage Units — 1H with Hinged Doors</b></p>	<p>ULOL-SN ULOD-SN UXOL-SN UXOD-SN <b>Overhead Storage Units — 1.5H with Hinged Doors</b></p>	<p>ULOL-SN ULOD-SN UXOL-SN UXOD-SN <b>Overhead Storage Units — 2H with Hinged Doors</b></p>	<p>ULRL-SN ULRD-SN UXRL-SN UXRD-SN <b>Overhead Storage Units — 1H with Sliding Door</b></p>	<p>ULRL-SN ULRD-SN UXRL-SN UXRD-SN <b>Overhead Storage Units — 1.5H with Sliding Door</b></p>	<p>ULRL-SN ULRD-SN UXRL-SN UXRD-SN <b>Overhead Storage Units — 2H with Sliding Door</b></p>	<p>ULML-SN ULMD-SN UXML-SN UXMD-SN <b>Overhead Storage Units — 1H with Glass Hinged Doors</b></p>
<p>ULML-SN ULMD-SN UXML-SN UXMD-SN <b>Overhead Storage Units — 1.5H with Glass Hinged Doors</b></p>	<p>ULML-SN ULMD-SN UXML-SN UXMD-SN <b>Overhead Storage Units — 2H with Glass Hinged Doors</b></p>	<p>ULLL-SN ULLD-SN UXLL-SN UXLD-SN <b>Overhead Storage Units — 1H with Glass Sliding Door</b></p>	<p>ULLL-SN ULLD-SN UXLL-SN UXLD-SN <b>Overhead Storage Units — 1.5H with Glass Sliding Door</b></p>	<p>ULLL-SN ULLD-SN UXLL-SN UXLD-SN <b>Overhead Storage Units — 2H with Glass Sliding Door</b></p>	<p>XWBB <b>Mounting Bracket Masters Overhead Storage Unit to Enclose</b></p>	

# Statement of Line

## Tackboards — pages 123-124

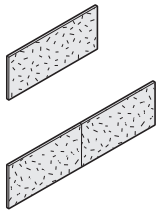

MTWD  
Tackboards —  
Wall Mount Overhead  
Storage Units — Fabric

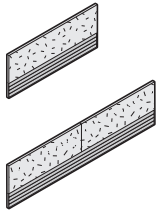

MTSW  
Tackboards —  
Wall Mount Overhead  
Storage Units — Fabric  
and Slat Rail

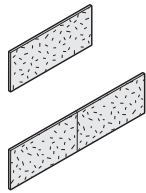

MTWD  
Fabric Tackboards

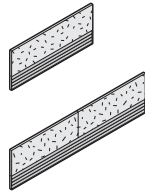

MTSW  
Fabric and Slat Rail

## Stack-On Storage — pages 125-127

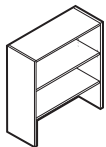

X4KL-SN  
X4KD-SN  
X5KL-SN  
X5KD-SN  
Stack-On Bookcase

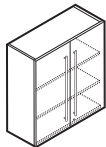

X4CL-SW  
X4CD-SW  
X5CL-SW  
X5CD-SW  
Stack-On Storage  
Cabinet with  
Hinged Doors

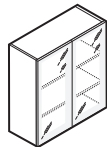

X4JL-ST  
X4JD-ST  
X5JL-ST  
X5JD-ST  
Stack-On Storage  
Cabinet with  
Glass Doors

## Reception Stations — pages 128-129

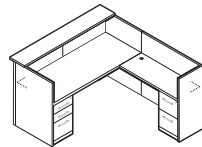

XZLR-RB  
L-Shaped Reception  
Station

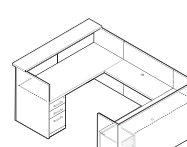

XZUR-RB  
U-Shaped Reception  
Station

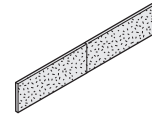
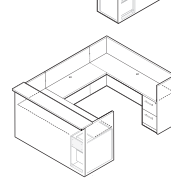
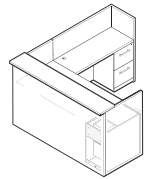

X4TR  
Tackboards — Reception  
Station L-Shaped and  
U-Shaped

## Modular Components — pages 130-144

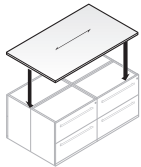

XLWT-SN  
XZWT-SN  
Common Storage Top  
with Two Profiled  
Edges

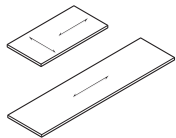

XLWF  
XZWF  
Modular Component  
— Credenza Top

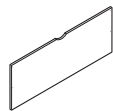

ULXF-SS  
UXXF-SS  
Full Overlay  
Modesty Panel



ULXH-SN2  
UXXH-SN2  
Hinged Modesty Panel



ULXS  
UXXS  
UFXS  
Adaptable Modesty  
Panel

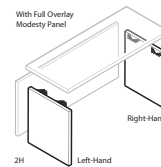

ULSE  
UXSE  
Modular Components  
— End Panel — 2H

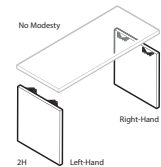

ULSE  
UXSE  
Modular Components  
— End Panel — 2H

# Statement of Line

## Modular Components (cont'd) — pages 130-144

**XLGS**  
**XZGS**  
**Modular Components — L-Support Panel**

**ULSL**  
**UXSL**  
**Modular Components — L-Support Panel**

**ULSL**  
**UXSL**  
**Modular Components — Partial Depth L-Support Panel — 2H**

**XLFS-SN**  
**XZFS-SN**  
**Modular Components — T-Support Panel**

**ULSX-SN**  
**UXSX-SN**  
**Modular Components — T-Support Panel — 2H**

**ULSS-S**  
**UXSS-S**  
**Modular Components — Mid-Support Panel — 2H**

## Storage — pages 145-177

**X4PA-NW**  
**X5PA-NL**  
**Attached Pedestals**

**X4PM-BW**  
**X5PM-BW**  
**Mobile Pedestal**

**XZSC-2116-FA**  
**Storage Cushion**

**X4FV-LW**  
**X5FV-LW**  
**1.5H Attached Lateral File with Open Shelf**







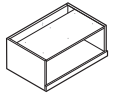
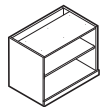
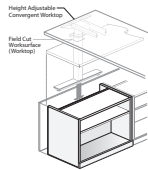
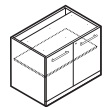

**X4F1-LW**  
**X5F1-LL**  
**1H High Attached Lateral Files**

**X4FB-LW**  
**X5FB-LL**  
**1.5H High Attached Lateral Files**

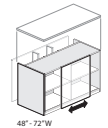
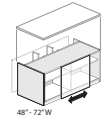
**X4FA-LW**  
**X5FA-LL**  
**2H High Attached Lateral Files**

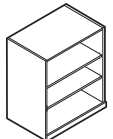
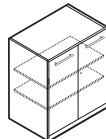
# Statement of Line

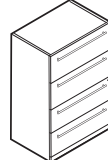
## Storage (cont'd) — pages 145-177

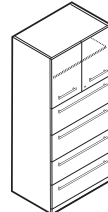
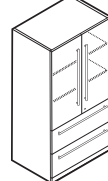
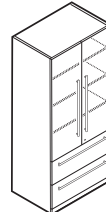
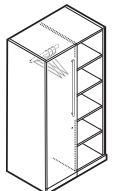
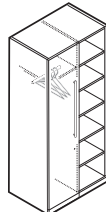
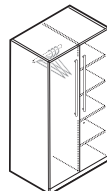
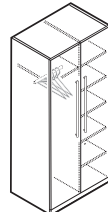
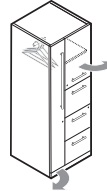
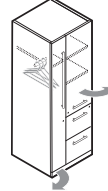
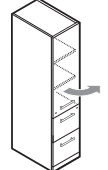
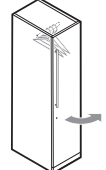
							
X4N1-NN X5N1-NN <b>1H Attached Storage Unit</b>	X4N2-NN X5N2-NN <b>2H Attached Storage Unit</b>	X5PB-1830 X4PB-1860 <b>1.5H Attached Storage for use with Convergent Worktop — Open Unit</b>	X4H2-LW X5H2-LL <b>2H Storage Unit with Doors</b>	X5SB-1848 X4SB-1848 <b>1.5H Attached Sliding Door Storage Unit</b>	X5CA-2348 X4CA-2348 <b>2H Attached Sliding Door Storage Unit</b>	X5CB-2348 X4CB-2348 <b>1.5H Attached Sliding Door Storage Unit for use with Convergent Worktop</b>	X5SA-1848 X4SA-1848 <b>2H Attached Sliding Door Storage Unit</b>
							
X4N3-NN X5N3-NN <b>3H Freestanding Open Storage Unit</b>	X4H3-LW X5H3-LL <b>3H Freestanding Storage Unit with Hinged Doors</b>	X4F3-LW X5F3-LL <b>Freestanding Lateral File — 3H</b>	X4F4-LW X5F4-LL <b>Freestanding Lateral File — 4H</b>	X4F5-LW X5F5-LL <b>Freestanding Lateral File — 5H</b>	X4F6-LW X5F6-LL <b>Freestanding Lateral File — 6H</b>	X4M5-LW X5M5-LL <b>Combination Unit — 5H</b>	X4M6-LW X5M6-LL <b>Combination Unit — 6H</b>
							
X4W5-WL X5W5-LL <b>Wardrobe with Open Unit — 5H</b>	X4W6-WL X5W6-LL <b>Wardrobe with Open Unit — 6H</b>	X4X5-LW X5X5-LL <b>Wardrobe with Closed Storage Unit — 5H</b>	X4X6-LW X5X6-LL <b>Wardrobe with Closed Storage Unit — 6H</b>	X4AD-WL X5AD-LL <b>Personal Storage Tower with F/F/F and Valet</b>	X4AF-WL X5AF-LL <b>Personal Storage Tower with F/F Pedestal and Valet — 5H and 6H</b>	X4ZF-WR X5ZF-LR <b>Storage Tower — 5H and 6H</b>	X4Y5-WR X5Y5-LR <b>Freestanding Wardrobe Tower — 5H</b>

# Statement of Line

## Storage (cont'd) — pages 145-177

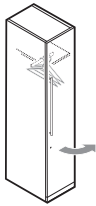

X4Y6-WR  
X5Y6-LR  
**Freestanding  
Wardrobe Tower —  
6H**

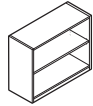

ULB2-S  
UXB2-S  
**Bookcase — 2H**

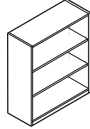

ULB3-S  
UXB3-S  
**Bookcase — 3H**

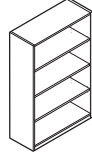

ULB4-S  
UXB4-S  
**Bookcase — 4H**

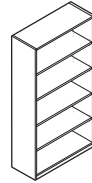

ULB5-S  
UXB5-S  
**Bookcase — 5H**



ULB6-S  
UXB6-S  
**Bookcase — 6H**

## Tables — pages 178

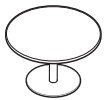

XZAM-1S  
**Table — Round**

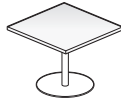

XLAS-3030  
XZAS-3030  
**Square Tables**

## Accessories — pages 179-181

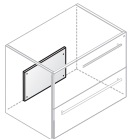

UXWA  
**Counterweight**



ZUBF-0000-PN  
**Flush Mount Plate**

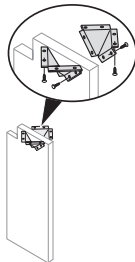

W111-5298  
**Tetra Bracket**

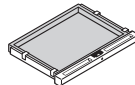

UXCD  
**Center Drawer**

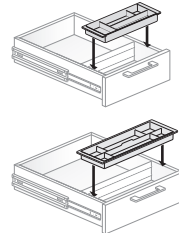

JPTA-6  
JPTA-9  
**Pencil Tray**

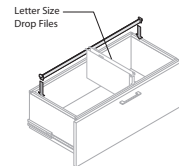

UXAH  
**File Bars**

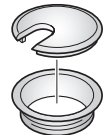

UXAG-0002  
**Grommet**



XZEC-NGB  
**Column Base**

This page intentionally blank



# Masters Series Product Catalog Number Code

## Masters Series Wood Product Catalog Number Code

**Example:** Masters Series Wood top single pedestal desk with full overlay modesty, 30"(762mm) deep, 60"(1524mm) wide, square wood edge, standard core, standard slides, one B/B/F pedestal with black miterfold drawers, finger pull, veneer drawer fronts and rectangular top.

<b>X</b>	<b>Z</b>	<b>S</b>	<b>F</b>	-	<b>30</b>	<b>60</b>	-	<b>1</b>	<b>S</b>	<b>S</b>	<b>5N</b>	<b>F</b>	<b>W</b>	<b>F</b>		
															Legend: B - Box Drawer F - File Drawer	
															<b>Top Shape Option:</b> F – Rectangular B – Bow Shaped	
															<b>Drawer Front:</b> L – Laminate W – Wood	
															<b>Drawer Pull Option:</b> F – Finger B – Bar 8 – Linear 9 – Classic	
															<b>Pedestal Drawer Option:</b> 5N – One B/B/F Black Miterfold SN – One B/B/F Wood	Available for Single Pedestal Desks Only
															55 – Two B/B/F Black Miterfold SS – Two B/B/F Wood 56 – One B/B/F and one F/F Black Miterfold ST – One B/B/F and one F/F Wood	Available for Double Pedestal Desks Only
															<b>Drawer Mechanism:</b> S – Standard Slide	
															<b>Core Material:</b> S – Standard	
															<b>Edge Option:</b> 1 – Square 5 – Bevel 6 – Radius 7 – Traditional J – 3mm Edgeband	
															<b>Width:</b> 60" – Single Pedestal Desk with Rectangular Top 66" – Single Pedestal/Double Pedestal Desk with Rectangular Top 72" – 78" – Single Pedestal/Double Pedestal Desk with Rectangular and Bow Top	
															<b>Depth:</b> 30" – Single/Double Pedestal Desk with Rectangular Top 36" – Single/Double Pedestal Desk with Rectangular and Bow Top	
															<b>Modesty:</b> F – Full Overlay H – Inset	
															<b>Product Type:</b> S – Single Pedestal Desks D – Double Pedestal Desks	
															<b>Finish:</b> L – Laminate Z – Wood	

**Product Line:**  
X – Masters Series

# Masters Series

## Single Pedestal Desks with Full Overlay

Height	Depth	Width	Number	①	②	③	Laminate A	B	Wood Group A	Group B	
<b>Laminate</b>											
29.125"(740mm)	30"(762mm)	60"(1524mm)	XLSF-3060-JSS	■	N	■	LF	\$2430.46	\$2488.32		
		66"(1676mm)	XLSF-3066-JSS	■	N	■	LF	2465.66	2526.27		
		72"(1829mm)	XLSF-3072-JSS	■	N	■	LF	2500.86	2564.22		
		78"(1981mm)	XLSF-3078-JSS	■	N	■	LF	2536.06	2602.17		
	36"(914mm)	66"(1676mm)	XLSF-3666-JSS	■	N	■	LF	\$2543.10	\$2609.76		
		72"(1829mm)	XLSF-3672-JSS	■	N	■	LF	2585.34	2655.30		
		78"(1981mm)	XLSF-3678-JSS	■	N	■	LF	2627.58	2700.84		
<b>Wood</b>											
29.125"(740mm)	30"(762mm)	60"(1524mm)	XZSF-3060-	■	SS	■	N	■	WF	\$3793.24	\$4179.19
		66"(1676mm)	XZSF-3066-	■	SS	■	N	■	WF	3864.29	4257.34
		72"(1829mm)	XZSF-3072-	■	SS	■	N	■	WF	3935.34	4335.49
		78"(1981mm)	XZSF-3078-	■	SS	■	N	■	WF	4006.39	4413.64
	36"(914mm)	66"(1676mm)	XZSF-3666-	■	SS	■	N	■	WF	\$4020.60	\$4429.27
		72"(1829mm)	XZSF-3672-	■	SS	■	N	■	WF	4105.86	4523.05
		78"(1981mm)	XZSF-3678-	■	SS	■	N	■	WF	4191.12	4616.83

### Single Pedestal Rectangular Top Desk with Full Overlay Modesty

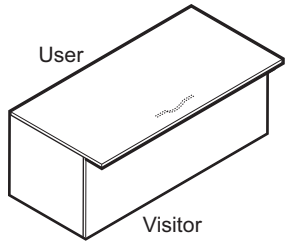
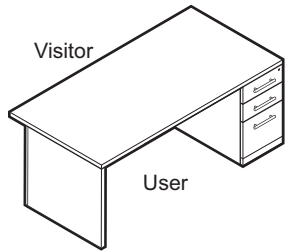

XLSF-LF  
XZSF-WF

### Features

- Includes worksurface, case and one pedestal.
- 1.1875"(30mm) thick laminate worksurface with 3mm edgeband applied to user and visitor edges only. Ends capped with 1mm thick edgeband. All other components finished in laminate with 1mm thick edgeband.
- 1.1875"(30mm) thick wood worksurface with a choice of profiled edge (Square, Bevel, Radius or Traditional) applied to user and visitor edges. Double-cut veneers available with Square 3mm Radius edge only.
- Full-overlay modesty panel recessed 6"(152mm) for visitor side overhang.
- Unfinished clearcoat wireway scallop in top center of modesty panel.
- Letter width 15.5"(394mm) pedestal.
- Box drawer with one black drawer divider per drawer and one black pencil tray per pedestal.
- File drawer with an integrated file hanging system.
- Drawer pull options:
  - Bar pulls available in powdercoat finishes.
  - Linear and Classic pulls are available in satin nickel finish only.
  - Finger pull option available with Wood Group B finishes.
- Box and file drawers have full extension slides.
- One lock standard per pedestal.
- Lock plug is available in black or chrome.
- For lock options, refer to Lock Program section of the Accessories Price List.
- Glides provide 2"(51mm) adjustment range.
- Desk shell shipped unassembled, pedestals shipped assembled ready for field installation.

### Specification Tips

- Non-handed design, allows pedestal location to be determined on site.
- Not for use with a Vertical Storage Unit.
- Accommodates separately specified center drawer.
- See Stack-on Application Rules for upper storage requirements.
- May be used as a freestanding/standalone desk or with separately specified attached modular components to design an L- or U-shaped application. See the Specification Guide for application guidelines.
- Separately specified grommets can be field installed in desk worksurface.

### To Order, Specify:

- 1) Product number, including:

#### ① Edge Option:

Wood:

- 1 Square
- 5 Bevel, starting \$186.52\* add to list
- 6 Radius, starting \$186.52\* add to list
- 7 Traditional, starting \$186.52\* add to list

#### ② Pedestal Drawer Option:

- 5 Box/Box/File Black Miterfold
- 5 Box/Box/File Wood, add \$147.14 list

#### ③ Drawer Pull Option:

- F Finger (Wood Group B only)
- B Bar
- 8 Linear
- 9 Classic

- 2) Finish code (laminate or wood).
- 3) Laminate edge trim for lower components (if laminate specified).
- 4) Laminate worksurface color (if laminate option specified).
- 5) Laminate edge trim for worksurface (if laminate option specified).
- 6) Trim color for bar pull (if specified).
- 7) Trim color for lock (required).

**Note:** Wood grained laminate worksurface finishes are applied with wood grain direction side-to-side only.

\*Additional upcharge based on size. Use design and specification tools for pricing.

### ④ Pull Styles

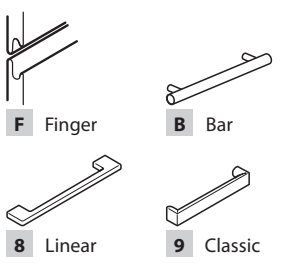

## Masters Series

## Single Pedestal Desks with Full Overlay

Height	Depth	Width	Number ① ② ③	Laminate		Wood	
				A	B	Group A	Group B
<b>Laminate</b>							
29.125"(740mm)	36"(914mm)	72"(1829mm)	XLSF-3672-JSS ■ N ■ LB	\$3121.29	\$3233.06		
		78"(1981mm)	XLSF-3678-JSS ■ N ■ LB	3192.93	3310.22		
<b>Wood</b>							
29.125"(740mm)	36"(914mm)	72"(1829mm)	XZSF-3672- ■ SS ■ N ■ WB			\$4887.38	\$5382.69
		78"(1981mm)	XZSF-3678- ■ SS ■ N ■ WB			5037.74	5548.05

## Single Pedestal Bow Top Desk with Full Overlay Modesty

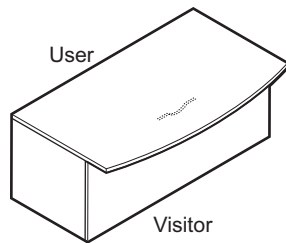
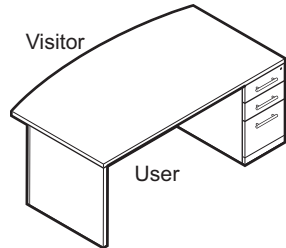
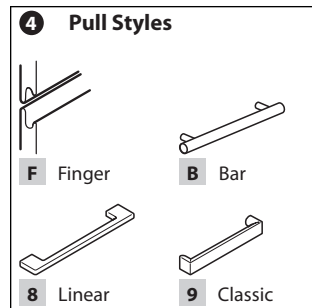
XLSF-LB  
XZSF-WB

## Features

- Includes worksurface, case and one pedestal.
- 1.1875"(30mm) thick laminate worksurface with 3mm edgeband applied to user and visitor edges only. Ends capped with 1mm thick edgeband. All other components finished in laminate with 1mm thick edgeband.
- 1.1875"(30mm) thick wood worksurface with a choice of profiled edge (Square, Bevel, Radius or Traditional) applied to user and visitor edges. Double-cut veneers available with Square 3mm Radius edge only.
- Full-overlay modesty panel recessed 6"(152mm) at end panels and 12"(305mm) at center of bow worksurface for visitor side overhang; worksurface depth at center of bow is 42"(1067mm).
- Unfinished clearcoat wireway scallop in top center of modesty panel.
- Letter width 15.5"(394mm) pedestal.
- Box drawer with one black drawer divider per drawer and one black pencil tray per pedestal.
- File drawer with an integrated file hanging system.
- Drawer pull options:
  - Bar pulls available in powdercoat finishes.
  - Linear and Classic pulls are available in satin nickel finish only.
  - Finger pull option available with Wood Group B finishes.
- Box and file drawers have full extension slides.
- One lock standard per pedestal.
- Lock plug is available in black or chrome.
- For lock options, refer to Lock Program section of the Accessories Price List.
- Glides provide 2"(51mm) adjustment range.
- Desk shell shipped unassembled, pedestals shipped assembled ready for field installation.

## Specification Tips

- Non-handed design, allows pedestal location to be determined on site.
- Not for use with a Vertical Storage Unit.
- Accommodates separately specified center drawer.
- See Stack-on Application Rules for upper storage requirements.
- May be used as a freestanding/standalone desk or with separately specified attached modular components to design an L- or U-shaped application. See the Specification Guide for application guidelines.
- Separately specified grommets can be field installed in desk worksurface.

## To Order, Specify:

- 1) Product number, including:

## ① Edge Option:

Wood:

- 1 Square
- 5 Bevel, starting \$223.84\* add to list
- 6 Radius, starting \$223.84\* add to list
- 7 Traditional, starting \$223.84\* add to list

## ② Pedestal Drawer Option:

- 5 Box/Box/File Black Miterfold
- 5 Box/Box/File Wood, add \$147.14 list

## ③ Drawer Pull Option:

- F Finger (Wood Group B only)
- B Bar
- 8 Linear
- 9 Classic

- 2) Finish code (laminate or wood).
- 3) Laminate edge trim for lower components (if laminate specified).
- 4) Laminate worksurface color (if laminate option specified).
- 5) Laminate edge trim for worksurface (if laminate option specified).
- 6) Trim color for bar pull (if specified).
- 7) Trim color for lock (required).

**Note:** Wood grained laminate worksurface finishes are applied with wood grain direction side-to-side only.

\*Additional upcharge based on size. Use design and specification tools for pricing.

# Masters Series

## Single Pedestal Desks with Inset Modesty

Height	Depth	Width	Number	① ② ③		Laminate	Wood	Group B
				A	B	Group A		
<b>Laminate</b>								
29.125"(740mm)	30"(762mm)	60"(1524mm)	XLSP-3060-JSS	N	LF	\$2838.62	\$2885.09	
		66"(1676mm)	XLSP-3066-JSS	N	LF	2881.02	2927.49	
		72"(1829mm)	XLSP-3072-JSS	N	LF	2923.42	2969.89	
		78"(1981mm)	XLSP-3078-JSS	N	LF	2965.82	3012.29	
36"(914mm)	66"(1676mm)	66"(1676mm)	XLSP-3666-JSS	N	LF	\$2974.30	\$3020.77	
		72"(1829mm)	XLSP-3672-JSS	N	LF	3025.18	3071.65	
		78"(1981mm)	XLSP-3678-JSS	N	LF	3076.06	3122.53	
<b>Wood</b>								
29.125"(740mm)	30"(762mm)	60"(1524mm)	XZSP-3060-	SS	N	WF	\$4591.57	\$5109.67
		66"(1676mm)	XZSP-3066-	SS	N	WF	4672.77	5200.22
		72"(1829mm)	XZSP-3072-	SS	N	WF	4753.97	5290.77
		78"(1981mm)	XZSP-3078-	SS	N	WF	4835.17	5381.32
36"(914mm)	66"(1676mm)	66"(1676mm)	XZSP-3666-	SS	N	WF	\$4851.41	\$5399.43
		72"(1829mm)	XZSP-3672-	SS	N	WF	4948.85	5508.09
		78"(1981mm)	XZSP-3678-	SS	N	WF	5046.29	5616.75

### Single Pedestal Rectangular Top Desk with Inset Modesty

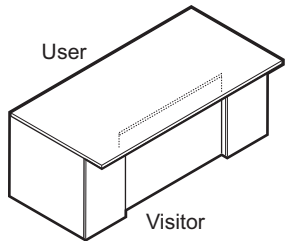
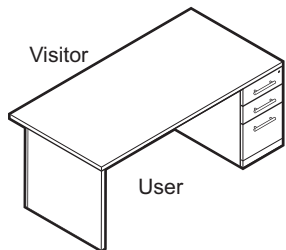

XLSP-LF  
XZSP-WF

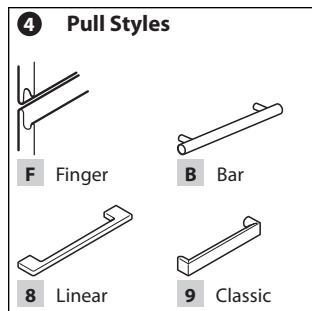

### Features

- Includes worksurface, case and one pedestal.
- 1.1875"(30mm) thick laminate worksurface with 3mm edgeband applied to user and visitor edges only. Ends capped with 1mm thick edgeband. All other components finished in laminate with 1mm thick edgeband.
- 1.1875"(30mm) thick wood worksurface with a choice of profiled edge (Square, Bevel, Radius or Traditional) applied to user and visitor edges. Double-cut veneers available with Square 3mm Radius edge only.
- Pedestal and false pedestal recessed 6"(152mm) with additional 2.25"(57mm) inset between for visitor side overhang.
- 1.5"(38mm) high horizontal wireway full width at top of inset modesty panel.
- Letter width 15.5"(394mm) pedestal.
- Box drawer with one black drawer divider per drawer and one black pencil tray per pedestal.
- File drawer with an integrated file hanging system.
- Drawer pull options:
  - Bar pulls available in powdercoat finishes.
  - Linear and Classic pulls are available in satin nickel finish only.
  - Finger pull option available with Wood Group B finishes.
- Box and file drawers have full extension slides.
- One lock standard per pedestal.
- Lock plug is available in black or chrome.
- For lock options, refer to Lock Program section of the Accessories Price List.
- Glides provide 2"(51mm) adjustment range.
- Desk shell shipped unassembled, pedestals shipped assembled ready for field installation.

### Specification Tips

- Non-handed design, allows pedestal location to be determined on site.
- Not for use with a Vertical Storage Unit.
- Accommodates separately specified center drawer.
- See Stack-on Application Rules for upper storage requirements.
- May be used as a freestanding/standalone desk or with separately specified attached modular components to design an L- or U-shaped application. See the Specification Guide for application guidelines.
- Separately specified grommets can be field installed in desk worksurface.

### To Order, Specify:

- 1) Product number, including:

#### ① Edge Option:

Wood:

- 1 Square
- 5 Bevel, starting \$250.19\* add to list
- 6 Radius, starting \$250.19\* add to list
- 7 Traditional, starting \$250.19\* add to list

#### ② Pedestal Drawer Option:

- 5 Box/Box/File Black Miterfold
- S Box/Box/File Wood, add \$147.14 list

#### ③ Drawer Pull Option:

- F Finger (Wood Group B only)
- B Bar
- 8 Linear
- 9 Classic

- 2) Finish code (laminate or wood).
- 3) Laminate edge trim for lower components (if laminate specified).
- 4) Laminate worksurface color (if laminate option specified).
- 5) Laminate edge trim for worksurface (if laminate option specified).
- 6) Trim color for bar pull (if specified).
- 7) Trim color for lock (required).

**Note:** Wood grained laminate worksurface finishes are applied with wood grain direction side-to-side only.

\*Additional upcharge based on size. Use design and specification tools for pricing.

## Masters Series

## Single Pedestal Desks with Inset Modesty

Height	Depth	Width	Number ① ② ③	Laminate		Wood		
				A	B	Group A	Group B	
<b>Laminate</b>								
29.125"(740mm)	36"(914mm)	72"(1829mm)	XLSP-3672-JSS	N	LB	\$3808.03	\$3854.50	
		78"(1981mm)	XLSP-3678-JSS	N	LB	3876.01	3922.48	
<b>Wood</b>								
29.125"(740mm)	36"(914mm)	72"(1829mm)	XZSP-3672-	SS	N	WB	\$5799.70	\$6358.94
		78"(1981mm)	XZSP-3678-	SS	N	WB	5914.24	6484.70

## Single Pedestal Bow Top Desk with Inset Modesty

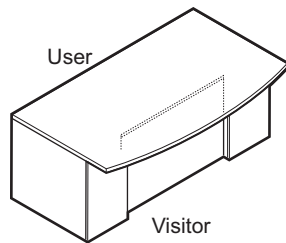
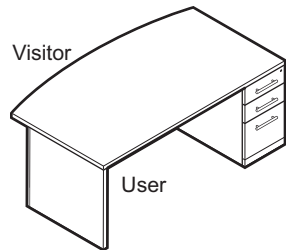

XLSP-LB  
XZSP-WB

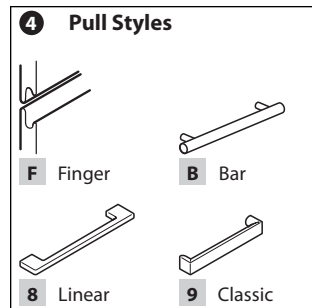

## Features

- Includes worksurface, case and one pedestal.
- 1.1875"(30mm) thick laminate worksurface with 3mm edgeband applied to user and visitor edges only. Ends capped with 1mm thick edgeband. All other components finished in laminate with 1mm thick edgeband.
- 1.1875"(30mm) thick wood worksurface with a choice of profiled edge (Square, Bevel, Radius or Traditional) applied to user and visitor edges. Double-cut veneers available with Square 3mm Radius edge only.
- Pedestal and false pedestal recessed 6"(152mm) with additional 2.25"(57mm) inset between for visitor side overhang; worksurface depth at center of bow is 42"(1067mm).
- 1.5"(38mm) high horizontal wireway full width at top of inset modesty panel.
- Letter width 15.5"(394mm) pedestal.
- Box drawer with one black drawer divider per drawer and one black pencil tray per pedestal.
- File drawer with an integrated file hanging system.
- Drawer pull options:
  - Bar pulls available in powdercoat finishes.
  - Linear and Classic pulls are available in satin nickel finish only.
  - Finger pull option available with Wood Group B finishes.
- Box and file drawers have full extension slides.
- One lock standard per pedestal.
- Lock plug is available in black or chrome.
- For lock options, refer to Lock Program section of the Accessories Price List.
- Glides provide 2"(51mm) adjustment range.
- Desk shell shipped unassembled, pedestals shipped assembled ready for field installation.

## Specification Tips

- Non-handed design, allows pedestal location to be determined on site.
- Not for use with a Vertical Storage Unit.
- Accommodates separately specified center drawer.
- See Stack-on Application Rules for upper storage requirements.
- May be used as a freestanding/standalone desk or with separately specified attached modular components to design an L- or U-shaped application. See the Specification Guide for application guidelines.
- Separately specified grommets can be field installed in desk worksurface.

## To Order, Specify:

- 1) Product number, including:

## ① Edge Option:

Wood:

- 1 Square
- 5 Bevel, starting \$250.19\* add to list
- 6 Radius, starting \$250.19\* add to list
- 7 Traditional, starting \$250.19\* add to list

## ② Pedestal Drawer Option:

- 5 Box/Box/File Black Miterfold
- 5 Box/Box/File Wood, add \$147.14 list

## ③ Drawer Pull Option:

- F Finger (Wood Group B only)
- B Bar
- 8 Linear
- 9 Classic

- 2) Finish code (laminate or wood).
- 3) Laminate edge trim for lower components (if laminate specified).
- 4) Laminate worksurface color (if laminate option specified).
- 5) Laminate edge trim for worksurface (if laminate option specified).
- 6) Trim color for bar pull (if specified).
- 7) Trim color for lock (required).

**Note:** Wood grained laminate worksurface finishes are applied with wood grain direction side-to-side only.

\*Additional upcharge based on size. Use design and specification tools for pricing.

# Masters Series

## Double Pedestal Desks with Full Overlay Modesty

Height	Depth	Width	Number ① ② ③	Laminate		Wood		
				A	B	Group A	Group B	
<b>Laminate</b>								
29.125"(740mm)	30"(762mm)	66"(1676mm)	XLDF-3066-JSS	LF	\$3324.54	\$3371.01		
		72"(1829mm)	XLDF-3072-JSS	LF	3385.79	3437.16		
		78"(1981mm)	XLDF-3078-JSS	LF	3447.04	3503.31		
36"(914mm)	66"(1676mm)		XLDF-3666-JSS	LF	\$3459.29	\$3516.54		
			XLDF-3672-JSS	LF	3532.79	3595.92		
			XLDF-3678-JSS	LF	3606.29	3675.30		
<b>Wood</b>								
29.125"(740mm)	30"(762mm)	66"(1676mm)	XZDF-3066-	SS WF		\$5377.54	\$5984.28	
		72"(1829mm)	XZDF-3072-	SS WF		5461.59	6076.83	
		78"(1981mm)	XZDF-3078-	SS WF		5545.64	6169.38	
36"(914mm)	66"(1676mm)		XZDF-3666-	SS WF		\$5562.45	\$6187.89	
			XZDF-3672-	SS WF		5663.31	6298.95	
			XZDF-3678-	SS WF		5764.17	6410.01	

### Double Pedestal Rectangular Top Desk with Full Overlay Modesty

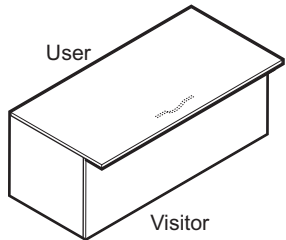
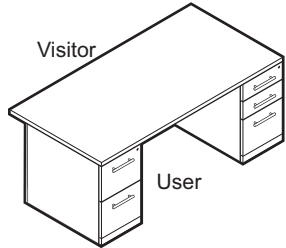

XLDF-LF  
XZDF-WF

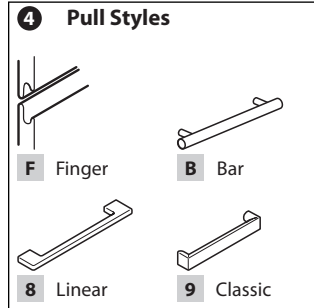

### Features

- Includes worksurface, case and two pedestals.
- 1.1875"(30mm) thick laminate worksurface with 3mm edgeband applied to user and visitor edges only. Ends capped with 1mm thick edgeband. All other components finished in laminate with 1mm thick edgeband.
- 1.1875"(30mm) thick wood worksurface with a choice of profiled edge (Square, Bevel, Radius or Traditional) applied to user and visitor edges. Double-cut veneers available with Square 3mm Radius edge only.
- Full-overlay modesty panel recessed 6"(152mm) for visitor side overhang.
- Unfinished clearcoat wireway scallop in top center of modesty panel.
- Choice of two Box/Box/File pedestals or one Box/Box/File and one File/File pedestal.
- Letter width 15.5"(394mm) pedestals.
- Box drawer with one black drawer divider per drawer and one black pencil tray per pedestal.
- File drawer with an integrated file hanging system.
- Drawer pull options:
  - Bar pulls available in powdercoat finish.
  - Linear and Classic pulls are available in satin nickel finish only.
  - Finger pull option available with Wood Group B finishes.
- Box and file drawers have full extension slides.
- One lock standard per pedestal; each pedestal locks separately.
- Common keys within each desk.
- Lock plug is available in black or chrome.
- For lock options, refer to Lock Program section of the Accessories Price List.
- Glides provide 2"(51mm) adjustment range.
- Desk shell shipped unassembled, pedestals shipped assembled ready for field installation.

### Specification Tips

- Non-handed design, allows pedestal location to be determined on site.
- Accommodates separately specified center drawer.
- For use as a freestanding/standalone desk; not for use with attached modular components.
- Not intended to be used with stack-on storage.
- Separately specified grommets can be field installed in desk worksurface.

### To Order, Specify:

- 1) Product number, including:

#### ① Edge Option:

Wood:

- 1 Square
- 5 Bevel, starting \$250.19\* add to list
- 6 Radius, starting \$250.19\* add to list
- 7 Traditional, starting \$250.19\* add to list

#### ② Pedestal Drawer Option:

- 55 Two Box/Box/File Black Miterfold
- 5S Two Box/Box/File Wood, add \$294.28 list
- 56 One Box/Box/File and One File/File Black Miterfold
- 5T One Box/Box/File and One File/File Wood, add \$306.10 list

#### ③ Drawer Pull Option:

- F Finger (Wood Group B only)
- B Bar
- 8 Linear
- 9 Classic

- 2) Finish code (laminate or wood).
- 3) Laminate edge trim for lower components (if laminate specified).
- 4) Laminate worksurface color (if laminate option specified).
- 5) Laminate edge trim for worksurface (if laminate option specified).
- 6) Trim color for bar pull (if specified).
- 7) Trim color for lock (required).

**Note:** Wood grained laminate worksurface finishes are applied with wood grain direction side-to-side only.

\*Additional upcharge based on size. Use design and specification tools for pricing.

## Masters Series

## Double Pedestal Desks with Full Overlay Modesty

Height	Depth	Width	Number ① ② ③	Laminate		Wood	
				A	B	Group A	Group B
<b>Laminate</b>							
29.125"(740mm)	36"(914mm)	72"(1829mm)	XLDF-3672-JSS ■ ■ LB	<b>\$4272.21</b>	<b>\$4348.02</b>		
		78"(1981mm)	XLDF-3678-JSS ■ ■ LB	<b>4345.71</b>	<b>4427.40</b>		
<b>Wood</b>							
29.125"(740mm)	36"(914mm)	72"(1829mm)	XZDF-3672- ■ SS ■ ■ WB			<b>\$6607.95</b>	<b>\$7337.91</b>
		78"(1981mm)	XZDF-3678- ■ SS ■ ■ WB			<b>6708.81</b>	<b>7448.97</b>

### Double Pedestal Bow Top Desk with Full Overlay Modesty

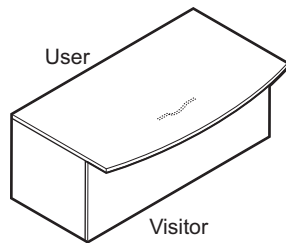
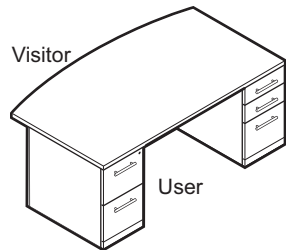

XLDF-LB  
XZDF-WB

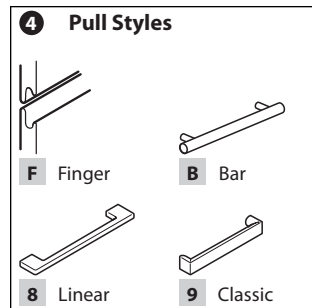

### Features

- Includes worksurface, case and two pedestals.
- 1.1875"(30mm) thick laminate worksurface with 3mm edgeband applied to user and visitor edges only. Ends capped with 1mm thick edgeband. All other components finished in laminate with 1mm thick edgeband.
- 1.1875"(30mm) thick wood worksurface with a choice of profiled edge (Square, Bevel, Radius or Traditional) applied to user and visitor edges. Double-cut veneers available with Square 3mm Radius edge only.
- Full-overlay modesty panel recessed 6"(152mm) at end panels and 12"(305mm) at center of bow worksurface for visitor side overhang; worksurface depth at center of bow is 42"(1067mm).
- Unfinished clearcoat wireway scallop in top center of modesty panel.
- Choice of two Box/Box/File pedestals or one Box/Box/File and one File/File pedestal.
- Letter width 15.5"(394mm) pedestals.
- Box drawer with one black drawer divider per drawer and one black pencil tray per pedestal.
- File drawer with an integrated file hanging system.
- Drawer pull options:
  - Bar pulls available in powdercoat finishes.
  - Linear and Classic pulls are available in satin nickel finish only.
  - Finger pull option available with Wood Group B finishes.
- Box and file drawers have full extension slides.
- One lock standard per pedestal; each pedestal locks separately.
- Common keys within each desk.
- Lock plug is available in black or chrome.
- For lock options, refer to Lock Program section of the Accessories Price List.
- Glides provide 2"(51mm) adjustment range.
- Desk shell shipped unassembled, pedestals shipped assembled ready for field installation.

### Specification Tips

- Non-handed design, allows pedestal location to be determined on site.
- Accommodates separately specified center drawer.
- For use as a freestanding/standalone desk; not for use with attached modular components.
- Not intended to be used with stack-on storage.
- Separately specified grommets can be field installed in desk worksurface.

### To Order, Specify:

- 1) Product number, including:

#### ① Edge Option:

Wood:

- 1 Square
- 5 Bevel, starting **\$250.19\*** add to list
- 6 Radius, starting **\$250.19\*** add to list
- 7 Traditional, starting **\$250.19\*** add to list

#### ② Pedestal Drawer Option:

- 55 Two Box/Box/File Black Miterfold
- 56 Two Box/Box/File Wood, add **\$294.28** list
- 56 One Box/Box/File and One File/File Black Miterfold
- 56 One Box/Box/File and One File/File Wood, add **\$306.10** list

#### ③ Drawer Pull Option:

- F Finger (Wood Group B only)
- B Bar
- 8 Linear
- 9 Classic

- 2) Finish code (laminate or wood).
- 3) Laminate edge trim for lower components (if laminate specified).
- 4) Laminate worksurface color (if laminate option specified).
- 5) Laminate edge trim for worksurface (if laminate option specified).
- 6) Trim color for bar pull (if specified).
- 7) Trim color for lock (required).

**Note:** Wood grained laminate worksurface finishes are applied with wood grain direction side-to-side only.

\*Additional upcharge based on size. Use design and specification tools for pricing.

# Masters Series

## Double Pedestal Desks with Inset Modesty

Height	Depth	Width	Number ① ② ③	Laminate A	B	Wood Group A	Group B
<b>Laminate</b>							
29.125"(740mm)	30"(762mm)	66"(1676mm)	XLDH-3066-JSS ■ ■ LF	\$3540.56	\$3587.03		
		72"(1829mm)	XLDH-3072-JSS ■ ■ LF	3605.26	3667.20		
		78"(1981mm)	XLDH-3078-JSS ■ ■ LF	3669.96	3747.37		
	36"(914mm)	66"(1676mm)	XLDH-3666-JSS ■ ■ LF	\$3628.47	\$3684.21		
		72"(1829mm)	XLDH-3672-JSS ■ ■ LF	3693.17	3764.38		
		78"(1981mm)	XLDH-3678-JSS ■ ■ LF	3757.87	3844.55		
<b>Wood</b>							
29.125"(740mm)	30"(762mm)	66"(1676mm)	XZDH-3066- ■ SS ■ ■ WF			\$5728.76	\$6379.32
		72"(1829mm)	XZDH-3072- ■ SS ■ ■ WF			5833.31	6494.31
		78"(1981mm)	XZDH-3078- ■ SS ■ ■ WF			5937.86	6609.30
	36"(914mm)	66"(1676mm)	XZDH-3666- ■ SS ■ ■ WF			\$5931.60	\$6598.27
		72"(1829mm)	XZDH-3672- ■ SS ■ ■ WF			6036.15	6713.26
		78"(1981mm)	XZDH-3678- ■ SS ■ ■ WF			6140.70	6828.25

### Double Pedestal Rectangular Top Desk with Inset Modesty

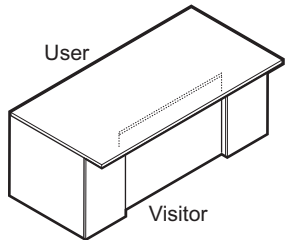
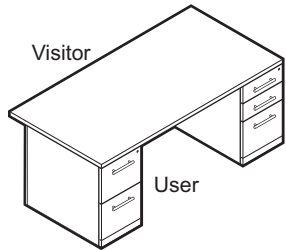

XLDH-LF  
XZDH-WF

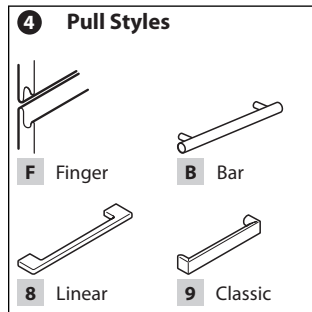

### Features

- Includes worksurface, case and two pedestals.
- 1.1875"(30mm) thick laminate worksurface with 3mm edgeband applied to user and visitor edges only. Ends capped with 1mm thick edgeband. All other components finished in laminate with 1mm thick edgeband.
- 1.1875"(30mm) thick wood worksurface with a choice of profiled edge (Square, Bevel, Radius or Traditional) applied to user and visitor edges. Double-cut veneers available with Square 3mm Radius edge only.
- Pedestals recessed 6"(152mm) with additional 2.25"(57mm) inset between for visitor side overhang.
- 1.5"(38mm) high horizontal wireway full width at top of inset modesty panel.
- Choice of two Box/Box/File pedestals or one Box/Box/File and one File/File pedestal.
- Letter width 15.5"(394mm) pedestals.
- Box drawer with one black drawer divider per drawer and one black pencil tray per pedestal.
- File drawer with an integrated file hanging system.
- Drawer pull options:
  - Bar pulls available in powdercoat finishes.
  - Linear and Classic pulls are available in satin nickel finish only.
  - Finger pull option available with Wood Group B finishes.
- Box and file drawers have full extension slides.
- One lock standard per pedestal; each pedestal locks separately.
- Common keys within each desk.
- Lock plug is available in black or chrome.
- For lock options, refer to Lock Program section of the Accessories Price List.
- Glides provide 2"(51mm) adjustment range.
- Desk shell shipped unassembled, pedestals shipped assembled ready for field installation.

### Specification Tips

- Non-handed design, allows for pedestal location to be determined on site.
- Accommodates separately specified center drawer.
- For use as a freestanding/standalone desk; not for use with attached modular components.
- Not intended to be used with stack-on storage.
- Separately specified grommets can be field installed in desk worksurface.

### To Order, Specify:

- 1) Product number, including:

#### ① Edge Option:

Wood:

- 1 Square
- 5 Bevel, starting \$250.19\* add to list
- 6 Radius, starting \$250.19\* add to list
- 7 Traditional, starting \$250.19\* add to list

#### ② Pedestal Drawer Option:

- 55 Two Box/Box/File Black Miterfold
- 55 Two Box/Box/File Wood, add \$294.28 list
- 56 One Box/Box/File and One File/File Black Miterfold
- 5T One Box/Box/File and One File/File Wood, add \$306.10 list

#### ③ Drawer Pull Option:

- F Finger (Wood Group B only)
- B Bar
- 8 Linear
- 9 Classic

- 2) Finish code (laminate or wood).
- 3) Laminate edge trim for lower components (if laminate specified).
- 4) Laminate worksurface color (if laminate option specified).
- 5) Laminate edge trim for worksurface (if laminate option specified).
- 6) Trim color for bar pull (if specified).
- 7) Trim color for lock (required).

**Note:** Wood grained laminate worksurface finishes are applied with wood grain direction side-to-side only.

\*Additional upcharge based on size. Use design and specification tools for pricing.



## Masters Series

## Double Pedestal Desks with Inset Modesty

Height	Depth	Width	Number ① ② ③	Laminate		Wood	
				A	B	Group A	Group B
<b>Laminate</b>							
29.125"(740mm)	36"(914mm)	72"(1829mm)	XLDH-3672-JSS ■ ■ LB	<b>\$4483.75</b>	<b>\$4554.96</b>		
		78"(1981mm)	XLDH-3678-JSS ■ ■ LB	<b>4548.45</b>	<b>4635.13</b>		
<b>Wood</b>							
29.125"(740mm)	36"(914mm)	72"(1829mm)	XZDH-3672- ■ SS ■ ■ WB			<b>\$6882.07</b>	<b>\$7559.18</b>
		78"(1981mm)	XZDH-3678- ■ SS ■ ■ WB			<b>6986.62</b>	<b>7674.17</b>

### Double Pedestal Bow Top Desk with Inset Modesty

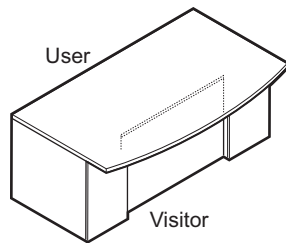
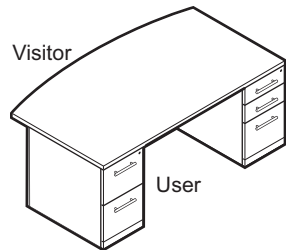

XLDH-LB  
XZDH-WB

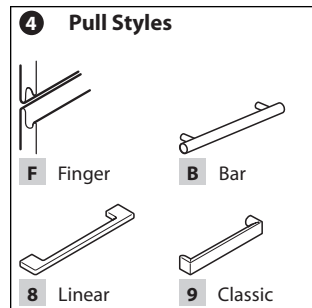

### Features

- Includes worksurface, case and two pedestals.
- 1.1875"(30mm) thick laminate worksurface with 3mm edgeband applied to user and visitor edges only. Ends capped with 1mm thick edgeband. All other components finished in laminate with 1mm thick edgeband.
- 1.1875"(30mm) thick wood worksurface with a choice of profiled edge (Square, Bevel, Radius or Traditional) applied to user and visitor edges. Double-cut veneers available with Square 3mm Radius edge only.
- Pedestals recessed 6"(152mm) with additional 2.25"(57mm) inset between for visitor side overhang; worksurface depth at center of bow is 42"(1067mm).
- 1.5"(38mm) high horizontal wireway full width at top of inset modesty panel.
- Choice of two Box/Box/File pedestals or one Box/Box/File and one File/File pedestal.
- Letter width 15.5"(394mm) pedestals.
- Box drawer with one black drawer divider per drawer and one black pencil tray per pedestal.
- File drawer with an integrated file hanging system.
- Drawer pull options:
  - Bar pulls available in powdercoat finishes.
  - Linear and Classic pulls are available in satin nickel finish only.
  - Finger pull option available with Wood Group B finishes.
- Box and file drawers have full extension slides.
- One lock standard per pedestal; each pedestal locks separately.
- Common keys within each desk.
- Lock plug is available in black or chrome.
- For lock options, refer to Lock Program section of the Accessories Price List.
- Glides provide 2"(51mm) adjustment range.
- Desk shell shipped unassembled, pedestals shipped assembled ready for field installation.

### Specification Tips

- Non-handed design, allows pedestal location to be determined on site.
- Accommodates separately specified center drawer.
- For use as a freestanding/standalone desk; not for use with attached modular components.
- Not intended to be used with stack-on storage.
- Separately specified grommets can be field installed in desk worksurface.

### To Order, Specify:

- 1) Product number, including:

#### ① Edge Option:

Wood:

- 1 Square
- 5 Bevel, starting **\$250.19\*** add to list
- 6 Radius, starting **\$250.19\*** add to list
- 7 Traditional, starting **\$250.19\*** add to list

#### ② Pedestal Drawer Option:

- 55 Two Box/Box/File Black Miterfold
- SS Two Box/Box/File Wood, add **\$294.28** list
- 56 One Box/Box/File and One File/File Black Miterfold
- ST One Box/Box/File and One File/File Wood, add **\$306.10** list

#### ③ Drawer Pull Option:

- F Finger (Wood Group B only)
- B Bar
- 8 Linear
- 9 Classic

- 2) Finish code (laminate or wood).
- 3) Laminate edge trim for lower components (if laminate specified).
- 4) Laminate worksurface color (if laminate option specified).
- 5) Laminate edge trim for worksurface (if laminate option specified).
- 6) Trim color for bar pull (if specified).
- 7) Trim color for lock (required).

**Note:** Wood grained laminate worksurface finishes are applied with wood grain direction side-to-side only.

\*Additional upcharge based on size. Use design and specification tools for pricing.

# Masters Series

## Desk Shells

Height	Depth	Width	Number ①	Laminate A	B	Wood Group A	Group B
<b>Laminate</b>							
29.125"(740mm)	30"(762mm)	60"(1524mm)	XLYH-3060-JSNF	\$2162.88	\$2350.98		
		66"(1676mm)	XLYH-3066-JSNF	2240.73	2435.03		
		72"(1829mm)	XLYH-3072-JSNF	2318.58	2519.08		
	36"(914mm)	66"(1676mm)	XLYH-3666-JSNF	\$2412.00	\$2619.94		
		72"(1829mm)	XLYH-3672-JSNF	2505.42	2720.80		
<b>Wood</b>							
29.125"(740mm)	30"(762mm)	60"(1524mm)	XZYH-3060-■ SSF			\$3302.88	\$3682.87
		66"(1676mm)	XZYH-3066-■ SSF			3449.83	3844.52
		72"(1829mm)	XZYH-3072-■ SSF			3596.78	4006.17
	36"(914mm)	66"(1676mm)	XZYH-3666-■ SSF			\$3773.12	\$4200.15
		72"(1829mm)	XZYH-3672-■ SSF			3949.46	4394.13

### Shell — Rectangular Top Desk

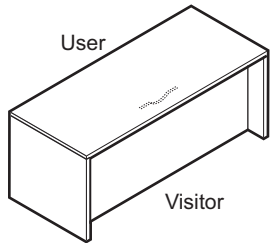
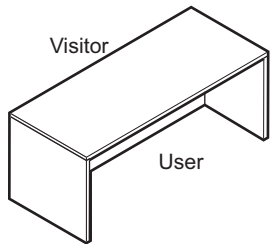

XLYH-SF  
XZYH-SF

### Features

- Includes worksurface, case and attachment hardware.
- 1.1875"(30mm) thick laminate worksurface with 3mm edgeband applied to user and visitor edges only. Ends capped with 1mm thick edgeband. All other components finished in laminate with 1mm thick edgeband.
- 1.1875"(30mm) thick wood worksurface with a choice of profiled edge (Square, Bevel, Radius or Traditional) applied to user and visitor edges. Double-cut veneers available with Square 3mm Radius edge only.
- Full-overlay modesty panel recessed 6"(152mm) for visitor side overhang.
- Unfinished clearcoat wireway scallop in top center of modesty panel.
- Glides provide 2"(51mm) adjustment range.
- Shipped unassembled.

### Specification Tips

- Accommodates separately specified box/box/file mobile pedestal without cushion.
- Not for use with a Vertical Storage Unit.
- Accommodates separately specified center drawer.
- See Stack-on Application Rules for upper storage requirements.
- May be used as a freestanding/standalone desk or with separately specified attached modular components to design an L- or U-shaped application. See the Specification Guide for application guidelines.
- Separately specified grommets can be field installed in desk worksurface.

### To Order, Specify:

- 1) Product number, including:

#### ① Edge Option:

Wood:

- 1 Square
- 5 Bevel, starting \$236.18\* add to list
- 6 Radius, starting \$236.18\* add to list
- 7 Traditional, starting \$236.18\* add to list

- 2) Finish code for lower components (laminate or wood).
- 3) Laminate edge trim for lower components (if laminate option specified).
- 4) Laminate worksurface color (if laminate option specified).
- 5) Laminate edge trim for worksurface (if laminate option specified).

**Note:** Wood grained laminate worksurface finishes are applied with wood grain direction side-to-side only.

\*Additional upcharge based on size. Use design and specification tools for pricing.

## Masters Series

Desk Shells

Height	Depth	Width	Number ①	Laminate		Wood	
				A	B	Group A	Group B
<b>Laminate</b>							
29.125"(740mm)	36"(914mm)	66"(1676mm)	XLYH-3666-JSNB	\$3218.40	\$3426.34		
		72"(1829mm)	XLYH-3672-JSNB	3311.82	3527.20		
<b>Wood</b>							
29.125"(740mm)	36"(914mm)	66"(1676mm)	XZYH-3666- SSB			\$4579.52	\$5006.55
		72"(1829mm)	XZYH-3672- SSB			4755.86	5200.53

## Shell — Bow Top Desk

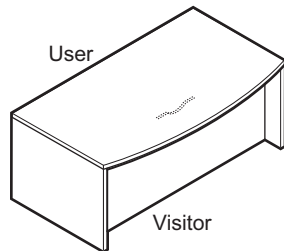
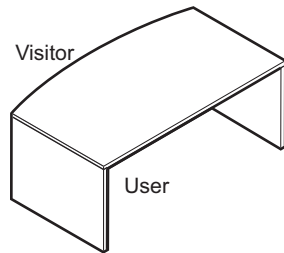

XLYH-SB  
XZYH-SB

## Features

- Includes worksurface, case and attachment hardware.
- 1.1875"(30mm) thick laminate worksurface with 3mm edgeband applied to user and visitor edges only. Ends capped with 1mm thick edgeband. All other components finished in laminate with 1mm thick edgeband.
- 1.1875"(30mm) thick wood worksurface with a choice of profiled edge (Square, Bevel, Radius or Traditional) applied to user and visitor edges. Double-cut veneers available with Square 3mm Radius edge only.
- Full-overlay modesty panel recessed 6"(152mm) at end panels and 12"(305mm) at center of bow worksurface for visitor side overhang; worksurface depth at center of bow is 42"(1067mm).
- Unfinished clearcoat wireway scallop in top center of modesty panel.
- Glides provide 2"(51mm) adjustment range.
- Shipped unassembled.

## Specification Tips

- Accommodates separately specified box/file mobile pedestal with or without cushion.
- Not for use with a Vertical Storage Unit.
- Accommodates separately specified center drawer.
- May not be used to support a Vertical Storage Unit.
- See Stack-on Application Rules for upper storage requirements.
- May be used as a freestanding/standalone desk or with separately specified attached modular components to design an L- or U-shaped application. See the Specification Guide for application guidelines.
- Separately specified grommets can be field installed in desk worksurface.

## To Order, Specify:

- 1) Product number, including:

## ① Edge Option:

Wood:

- 1 Square
- 5 Bevel, starting \$263.90\* add to list
- 6 Radius, starting \$263.90\* add to list
- 7 Traditional, starting \$263.90\* add to list

- 2) Finish code for lower components (laminate or wood).
- 3) Laminate edge trim for lower components (if laminate option specified).
- 4) Laminate worksurface color (if laminate option specified).
- 5) Laminate edge trim for worksurface (if laminate option specified).

**Note:** Wood grained laminate worksurface finishes are applied with wood grain direction side-to-side only.

\*Additional upcharge based on size. Use design and specification tools for pricing.

# Masters Series

## Table Desk — Rectangular — Hoop Leg

Depth	Width	Number ① ② ③	Laminate		Wood Group A	Wood Group B
			A	B	Edge Options 1	Edge Options 1 5,6,7
30"(762mm)	60"(1524mm)	X ■ AR-3060- ■ SNH ■	\$1951.26	\$2094.47	\$2883.90	\$2934.14 \$3074.01
	66"(1676mm)	X ■ AR-3066- ■ SNH ■	1998.36	2141.57	2955.15	3006.74 3146.61
	72"(1829mm)	X ■ AR-3072- ■ SNH ■	2045.46	2188.67	3026.40	3079.34 3219.21
36"(914mm)	60"(1524mm)	X ■ AR-3660- ■ SNH ■	\$2045.46	\$2188.67	\$3026.40	\$3079.34 \$3219.21
	66"(1676mm)	X ■ AR-3666- ■ SNH ■	2101.98	2245.19	3111.90	3166.46 3306.33
	72"(1829mm)	X ■ AR-3672- ■ SNH ■	2158.50	2301.71	3197.40	3253.58 3393.45
	78"(1981mm)	X ■ AR-3678- ■ SNH ■	2215.02	2358.23	3282.90	3340.70 3480.57
	84"(2134mm)	X ■ AR-3684- ■ SNH ■	2271.54	2414.75	3368.40	3427.82 3567.69
42"(1067mm)	72"(1829mm)	X ■ AR-4272- ■ SNH ■	\$2271.54	\$2414.75	\$3368.40	\$3427.82 \$3567.69
	78"(1981mm)	X ■ AR-4278- ■ SNH ■	2337.48	2480.69	3468.15	3529.46 3669.33
	84"(2134mm)	X ■ AR-4284- ■ SNH ■	2403.42	2546.63	3567.90	3631.10 3770.97

### Table Desk — Rectangular — Hoop Leg

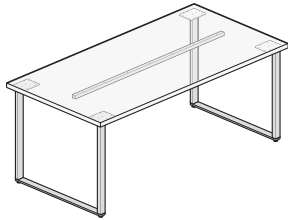

XLAR-3072  
XZAR-3072

#### Features

- Includes 1.1875"(36mm) thick top, two hoop legs and attachment hardware.
- Reinforcement Bar added to 72"(1829mm), 78"(1981mm) and 84"(2134mm) worktops with hoop leg.
- Laminate worksurface with 3mm edgeband applied to user and visitor edges only. Ends capped with 1mm thick edgeband.
- Wood worksurface with a choice of profiled edge (Square, Bevel, Radius and Traditional) applied to user and visitor edges. Double-cut wood worksurface available with Square 3mm Radius edge only.
- Glides have .5"(13mm) height adjustment and are standard in black.
- Depth and width shown in nominal dimensions.
- Ships unassembled.

#### Specification Tips

- For use as a freestanding/standalone desk; not for use with attached modular components.
- May be used with separately specified Adaptable Modesty Panel.
- May be used with separately specified Belong Screen.

#### Electrical:

- For use with separately specified electrical components: (Note: All of the options shown below require field cut mounting holes in the top. Ensure placement provides adequate clearance for table understructure. Ensure placement provides adequate clearance for table understructure.)
  - Flush Mounted Power Module Cord for Height Adjustable or Hardwire
  - Enhanced Power Module Corded or Hardwire with mounting bracket
  - Flip Top Unit Corded or Hardwire
  - Workware connect narrow non-switching interface module
  - Bezel Utility Module
- To limit cords connected to the building power use Power Modules with IEC connector.

#### To Order, Specify:

1) Product number, including:

#### ① Surface Option:

- L** Laminate
- Z** Wood

#### ② Edge Option:

- J** Edgeband (Laminate only)
- 1** Square (Wood only)
- 5** Bevel (Wood only)
- 6** Radius (Wood only)
- 7** Traditional (Wood only)

#### ③ Leg Finish:

- B** Paint
- C** Chrome, add **\$550.81** list

2) Laminate surface color or wood finish color.

3) Edge trim color (laminate only).

4) Base trim color.

**Note:** \$56.58 upcharge (list) for Metallic and accent trim colors.

This page intentionally blank

# Masters Series

Height Adjustable Table Desk — Rectangular Top — T-Leg Base

## Height Adjustable Table Desk — Rectangular Top — T-Leg Base

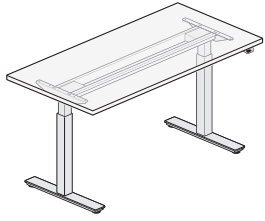

XLAR-3060  
XZAR-3060

### Features

- Includes 1.1875" (36mm) thick top, two T-leg base assemblies, wire management clips, height adjustment mechanism and hardware.
- Laminate worksurface with 3mm edgeband applied to user and visitor edges only. Ends capped with 1mm thick edgeband.
- Wood worksurface with a choice of profiled edge (Square, Bevel, Radius and Traditional) applied to user and visitor edges. Double-cut wood worksurface available with Square 3mm Radius edge only.
- Top available with standard core.
- Height adjustment touch pad actuator options:
  - Single Stage Touch Pad Actuator available in Standard (E) up/down movement or Programmable (R) providing four different up/down programmed heights. Provides 27" (686mm) to 46" (1168mm) continuous height adjustment range.
- Touch Pad Actuator:
  - Can be mounted on left or right side of table; predrilled for field installed and field changeable.
  - Touch pad actuator has touch pad controls and standard with black housing.
  - Control box is field installed and standard with black housing.
- Height adjustment: 1" (25mm) per 1.6 seconds.
- Telescoping base tubes and J-rails. Telescoping base tubes will match base trim color. Smooth paint trim will match. Textured paint will be complimentary.
- Includes: 9.5' (2895.6mm) long black power cord with NEMA 5-15P plug to the building.
- Base includes leg assembly and foot; available in painted trim colors.
- Glides have .5" (13mm) height adjustment and are standard in black.
- Grommets are available for field installation; separately specified.
- Ships unassembled.

### Specification Tips

- Tops are designed to allow pinch point clearance to accommodate cables. The undersized top provides:
  - 1" (25mm) gap along each side of the top between the adjacent furnishings or building architecture.
  - 1" (25mm) gap along the back of the top between the adjacent furnishings or building architecture
- A shroud is an aesthetic cover used to conceal a Height Adjustable T-Leg.
- Separately specified Reinforcement Channel or Bar are not required.
- **For a Height Adjustable Table Desk Shroud application:**
  - Separately specify Shroud for use with Adjustable T-Legs; a pair of shrouds are recommended.
  - An optional, separately specified Modesty Panel for Shroud may be used.
- A Height Adjustable Table Desk without shrouds may be used with a separately specified Adaptable Modesty Panel.

### Electrical:

- For use with separately specified electrical components: (Note: All of the options shown below require field cut mounting holes in the top. Ensure placement provides adequate clearance for table understructure.)
  - Flush Mounted Power Module Cord for Height Adjustable or Hardwire
  - Enhanced Power Module Corded or Hardwire with mounting bracket
  - Flip Top Unit Corded or Hardwire
  - Workware connect narrow non-switching interface module
  - Bezel Utility Module
- To limit cords connected to the building power use Power Modules with IEC connector.
- Height Adjustable Tables Desk is not for use with AKP's, suspended or attached pedestals.
- Total lifting capacity of table is 250 lbs. including surface; applied weight should be evenly distributed.

### To Order, Specify:

1) Product number, including:

#### ① Surface Option:

- L** Laminate
- Z** Wood

#### ② Edge Option:

- J** Edgeband (Laminate only)
- 1** Square (Wood only)
- 5** Bevel (Wood only)
- 6** Radius (Wood only)
- 7** Traditional (Wood only)

#### ③ Height Adjustment Actuator Option:

Single Stage:

- E** Standard
- R** Programmable, add **\$187.41** list

- 2) Laminate surface color or wood finish color.
- 3) Edge trim color (laminate only).
- 4) Base trim color.

**Note:** **\$56.58** upcharge (list) for Metallic and accent trim colors.

Table Depth and Base	Screens	Monitor Arms
29" (737mm) T-Leg Glides	Yes	Yes (50 lbs max)
35" (889mm) T-Leg Glides	Yes	Yes (50 lbs max)
41" (1041mm) T-Leg Glides	Yes	Yes (50 lbs max)

## Masters Series

Height Adjustable Table Desk — Rectangular Top — T-Leg Base

Actual Depth	Actual Width	Number			Laminate		Wood Group A	Wood Group B	
		①	②	③	A	B	Edge Options 1	Edge Options 1	5,6,7
29"(737mm)	58"(1473mm)	X	AR-3060-	SNTB	\$2669.82	\$2823.05	\$3806.72	\$3879.70	\$4018.18
	64"(1626mm)	X	AR-3066-	SNTB	2716.92	2870.15	3877.77	3952.05	4090.53
	70"(1778mm)	X	AR-3072-	SNTB	2764.02	2917.25	3948.82	4024.40	4162.88
35"(889mm)	58"(1473mm)	X	AR-3660-	SNTB	\$2764.02	\$2917.25	\$3948.82	\$4024.40	\$4162.88
	64"(1626mm)	X	AR-3666-	SNTB	2820.54	2973.77	4034.08	4111.22	4249.70
	70"(1778mm)	X	AR-3672-	SNTB	2877.06	3030.29	4119.34	4198.04	4336.52
	76"(1930mm)	X	AR-3678-	SNTB	2933.58	3086.81	4204.60	4284.86	4423.34
41"(1041mm)	82"(2083mm)	X	AR-3684-	SNTB	2990.10	3143.33	4289.86	4371.68	4510.16
	70"(1778mm)	X	AR-4272-	SNTB	\$2990.10	\$3143.33	\$4289.86	\$4371.68	\$4510.16
	76"(1930mm)	X	AR-4278-	SNTB	3056.04	3209.27	4389.33	4472.97	4611.45
	82"(2083mm)	X	AR-4284-	SNTB	3121.98	3275.21	4488.80	4574.26	4712.74

# Masters Series

## Height Adjustable Convergent Worktop — T-Leg – Rectangular

### Height Adjustable Convergent Worktop — T-Leg – Rectangular

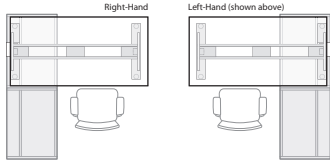
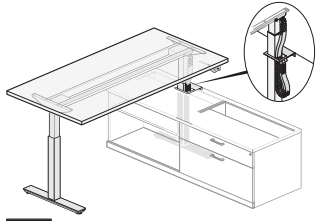

XLNR-3060  
XZNR-3060

### Features

- Includes 1.1875" (30mm) convergent worktop, wire management clips, black cable chain, power cord, bezel, attachment hardware, height adjustment mechanism, two T-leg base and adjustable glides.
- Laminate worktop with 3mm edgeband applied to user and visitor edges only. Ends capped with 1mm thick edgeband.
- Wood worktop with a choice of profiled edge (Square, Bevel, Radius and Traditional) applied to user and visitor edges. Double-cut wood worktop available with Square 3mm Radius edge only.
- Glides provide .5" (13mm) vertical adjustment.
- Bezel is a metal plate which goes around the column to hide the cutout in top of the storage.
- Height adjustment touch pad actuator options:
  - Single Stage Touch Pad Actuator available in Standard (E) up/down movement or Programmable (R) providing four different up/down heights. Provides 27" (686mm) to 46" (1168mm) continuous height adjustment range.
- Programmable Touch Pad Actuator:
  - Can be mounted on left or right side of table; predrilled for field installed and field changeable.
  - Touch pad actuator has touch pad controls and standard with black housing.
  - Control box is field installed and standard with black housing.
- Height adjustment: 1" (25mm) per 1.6 seconds.
- Telescoping base tubes and J-rails. Telescoping base tubes will match base trim color. Smooth paint trim will match. Textured paint will be complementary.
- Includes: 9.5' (2895.6mm) long black power cord with NEMA 5-15P plug to the building.
- Base includes leg assembly and foot; available in painted trim colors.
- Glides have .5" (13mm) height adjustment and are standard in black.
- Grommets are available for field installation; separately specified.
- Ships unassembled.

### Specification Tips

- Designed to be used with one of the following separately specified 1.5H lower storage units:
  - 1.5H Attached Sliding Door Storage Unit for use with Convergent Worktop; available 23" (584mm)D, only.
  - 1.5H Attached Storage for use with Convergent Worktop - Open Unit; 18" (457mm)D or 23" (584mm).
- Separately specified Reinforcement Channel or Bar are not required.
- Not for use with 1.5H Attached Sliding Door Unit.
- One of the two Height Adjustable T-Legs is concealed within the full height raceway in the back of the 1.5H lower storage unit and the other is exposed.
- A separately specified Shroud for use with Height Adjustable T-Leg may be used as an aesthetic cover for the exposed Height Adjustable T-Leg.
- Trim Finish Recommendation: The bezel on the shroud and the convergent leg to be specified the same color.
- The bezel mounts to the credenza top on the 1.5H lower storage. Installation hole for bezel to be field cut.
- Convergent worktop (with or without a shroud) may be used with a separately specified Adaptable Modesty Panel.

### Electrical:

- For use with separately specified electrical components:
  - (Note: All of the options shown below require field cut mounting holes in the top. Ensure placement provides adequate clearance for table understructure.)
  - Flush Mounted Power Module Cord for Height Adjustable or Hardwire
  - Enhanced Power Module Corded or Hardwire with mounting bracket
  - Flip Top Unit Corded or Hardwire
  - Workware connect narrow non-switching interface module
  - Bezel Utility Module
- To limit cords connected to the building power use Power Modules with IEC connector.
- **Height Adjustable Convergent Worktop is not for use with AKP's, suspended or attached pedestals.**
- Worktop load capacity: 100 pounds
- Worktop load capacity (including top) and weight should be evenly distributed.
- Screen and Monitor Arm application:
  - 29" (737mm), 35" (889mm) and 41" (1041mm) deep table supports a 27" (686mm) high Belong screen and a monitor up to 50 lbs.

### To Order, Specify:

- 1) Product number, including:

#### ① Surface Option:

- L** Laminate
- Z** Wood

#### ② Edge Option:

- J** Edgeband (Laminate only)
- 1** Square (Wood only)
- 5** Bevel (Wood only)
- 6** Radius (Wood only)
- 7** Traditional (Wood only)

#### ③ Height Adjustment Actuator Option:

##### Single Stage:

- E** Standard
- R** Programmable, add **\$187.41** list

- 2) Laminate surface color or wood finish color.
- 3) Edge trim color (laminate only).
- 4) Base trim color.

**Note:** **\$56.58** upcharge (list) for Metallic and accent trim colors.



# Masters Series

Height Adjustable Convergent Worktop — T-Leg – Rectangular

Actual Depth	Actual Width	Number			Laminate		Wood Group A	Wood Group B	
		①	②	③	A	B	Edge Options 1	Edge Options 1	5,6,7
29"(737mm)	58"(1473mm)	X	NR-3060-	SNTB	\$2949.60	\$3092.81	\$4304.68	\$4380.20	\$4520.07
	64"(1626mm)	X	NR-3066-	SNTB	2996.70	3139.91	4375.93	4452.80	4592.67
	70"(1778mm)	X	NR-3072-	SNTB	3043.80	3187.01	4447.18	4525.40	4665.27
35"(889mm)	58"(1473mm)	X	NR-3660-	SNTB	\$3043.80	\$3187.01	\$4447.18	\$4525.40	\$4665.27
	64"(1626mm)	X	NR-3666-	SNTB	3100.32	3243.53	4532.68	4612.52	4752.39
	70"(1778mm)	X	NR-3672-	SNTB	3156.84	3300.05	4618.18	4699.64	4839.51
	76"(1930mm)	X	NR-3678-	SNTB	3213.36	3356.57	4703.68	4786.76	4926.63
41"(1041mm)	82"(2083mm)	X	NR-3684-	SNTB	3269.88	3413.09	4789.18	4873.88	5013.75
	70"(1778mm)	X	NR-4272-	SNTB	\$3269.88	\$3413.09	\$4789.18	\$4873.88	\$5013.75
	76"(1930mm)	X	NR-4278-	SNTB	3335.82	3479.03	4888.93	4975.52	5115.39
	82"(2083mm)	X	NR-4284-	SNTB	3401.76	3544.97	4988.68	5077.16	5217.03

# Masters Series

## Height Adjustable Convergent Worktop — T-Leg – Wedge Square

### Height Adjustable Convergent Worktop — T-Leg – Wedge Square

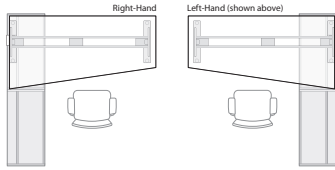
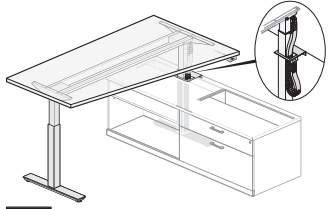

XLNW-4260  
XZNW-4260

### Features

- Includes 1.1875" (30mm) convergent worktop, wire management clips, black cable chain, power cord, bezel, attachment hardware, height adjustment mechanism, two T-leg base and adjustable glides.
- Laminate worktop with 3mm edgeband applied to user and visitor edges only. Ends capped with 1mm thick edgeband.
- Wood worktop with a choice of profiled edge (Square, Bevel, Radius and Traditional) applied to user and visitor edges. Double-cut wood worktop available with Square 3mm Radius edge only.
- Glides provide .5" (13mm) vertical adjustment.
- Bezel is a metal plate which goes around the column to hide the cutout in top of the storage.
- The cable chain is located on the back of the leg for right-hand convergent; front of the leg on left-hand convergent.
- Height adjustment touch pad actuator options:
  - Single Stage Touch Pad Actuator available in Standard (E) up/down movement or Programmable (R) providing four different up/down heights. Provides 27" (686mm) to 46" (1168mm) continuous height adjustment range.
  - Programmable Touch Pad Actuator:
    - Can be mounted on left or right side of table; predrilled for field installed and field changeable.
    - Touch pad actuator has touch pad controls and standard with black housing.
    - Control box is field installed and standard with black housing.
- Height adjustment: 1" (25mm) per 1.6 seconds.
- Telescoping base tubes and J-rails. Telescoping base tubes will match base trim color. Smooth paint trim will match. Textured paint will be complimentary.
- Includes: 9.5' (2895.6mm) long black power cord with NEMA 5-15P plug to the building.
- Base includes leg assembly and foot; available in painted trim colors.
- Glides have .5" (13mm) height adjustment and are standard in black.
- Grommets are available for field installation; separately specified.
- Ships unassembled.

### Specification Tips

- Designed to be used with one of the following separately specified 1.5H lower storage units:
  - 1.5H Attached Sliding Door Storage Unit for use with Convergent Worktop; available 23" (584mm) D, only.
  - 1.5H Attached Storage for use with Convergent Worktop - Open Unit; 18" (457mm) D or 23" (584mm).
- Separately specified Reinforcement Channel or Bar are not required.
- Not for use with 1.5H Attached Sliding Door Unit.
- One of the two Height Adjustable T-Legs is concealed within the full height raceway in the back of the 1.5H lower storage unit and the other is exposed.
- A separately specified Shroud for use with Height Adjustable T-Leg may be used as an aesthetic cover for the exposed Height Adjustable T-Leg.
- Trim Finish Recommendation: The bezel on the shroud and the convergent leg to be specified the same color.
- The bezel mounts to the credenza top on the 1.5H lower storage. Installation hole for bezel to be field cut.
- Convergent worktop (with or without a shroud) may be used with a separately specified Adaptable Modesty Panel.

### Electrical:

- For use with separately specified electrical components: (Note: All of the options shown below require field cut mounting holes in the top. Ensure placement provides adequate clearance for table understructure.)
  - Flush Mounted Power Module Cord for Height Adjustable or Hardwire
  - Enhanced Power Module Corded or Hardwire with mounting bracket
  - Flip Top Unit Corded or Hardwire
  - Workware connect narrow non-switching interface module
  - Bezel Utility Module
- To limit cords connected to the building power use Power Modules with IEC connector.
- **Height Adjustable Convergent Worktop is not for use with AKP's, suspended or attached pedestals.**
- Worktop load capacity: 100 pounds
- Worktop load capacity (including top) and weight should be evenly distributed.
- Screen and Monitor Arm application:
  - 29" (737mm), 35" (889mm) and 41" (1041mm) deep table supports a 27" (686mm) high Belong screen and a monitor up to 50 lbs.

### To Order, Specify:

- 1) Product number, including:

#### 1 Surface Option:

- L** Laminate
- Z** Wood

#### 2 Edge Option:

- J** Edgeband (Laminate only)
- 1** Square (Wood only)
- 5** Bevel (Wood only)
- 6** Radius (Wood only)
- 7** Traditional (Wood only)

#### 3 Orientation Option:

- R** Right-hand
- L** Left-hand

#### 4 Height Adjustment Actuator Option:

Single Stage:

- E** Standard
- R** Programmable, add **\$187.41** list

- 2) Laminate surface color or wood finish color.
- 3) Edge trim color (laminate only).
- 4) Base trim color.

**Note:** **\$56.58** upcharge (list) for Metallic and accent trim colors.

**Masters Series**

Height Adjustable Convergent Worktop — T-Leg – Wedge Square

Actual Depth	Actual Width	Number ①	②	③	④	Laminate		Wood Group A	Wood Group B			
						A	B	Edge Options 1	Edge Options 1	5,6,7		
41"(1041mm)	58"(1473mm)	X	NW-4260-	S	TB			\$3309.35	\$3452.56	\$4847.42	\$4933.51	\$5073.38
	64"(1626mm)	X	NW-4266-	S	TB			3375.29	3518.50	4947.17	5035.15	5175.02
	70"(1778mm)	X	NW-4272-	S	TB			3441.23	3584.44	5046.92	5136.79	5276.66
	76"(1930mm)	X	NW-4278-	S	TB			3507.17	3650.38	5146.67	5238.43	5378.30
	82"(2083mm)	X	NW-4284-	S	TB			3573.11	3716.32	5246.42	5340.07	5479.94
47"(1194mm)	58"(1473mm)	X	NW-4860-	S	TB			\$3403.55	\$3546.76	\$4989.92	\$5078.71	\$5218.58
	64"(1626mm)	X	NW-4866-	S	TB			3478.91	3622.12	5103.92	5194.87	5334.74
	70"(1778mm)	X	NW-4872-	S	TB			3554.27	3697.48	5217.92	5311.03	5450.90
	76"(1930mm)	X	NW-4878-	S	TB			3629.63	3772.84	5331.92	5427.19	5567.06
	82"(2083mm)	X	NW-4884-	S	TB			3704.99	3848.20	5445.92	5543.35	5683.22

# Masters Series

## Height Adjustable Convergent Worktop — T-Leg – Wedge Radius

### Height Adjustable Convergent Worktop — T-Leg – Wedge Radius

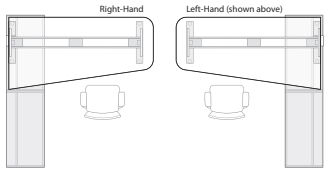
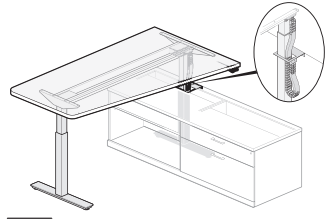

XLNG-4260  
XZNG-4260

### Features

- Includes 1.1875" (30mm) convergent worktop, wire management clips, black cable chain, power cord, bezel, attachment hardware, height adjustment mechanism, two T-leg base and adjustable glides.
- Laminate worktop with 3mm edgeband applied to user and visitor edges only. Ends capped with 1mm thick edgeband.
- Wood worktop with a choice of profiled edge (Square, Bevel, Radius and Traditional) applied to user and visitor edges. Double-cut wood worktop available with Square 3mm Radius edge only.
- Glides provide .5" (13mm) vertical adjustment.
- Bezel is a metal plate which goes around the column to hide the cutout in top of the storage.
- The cable chain is located on the back of the leg for right-handed convergent; front of the leg on left-hand convergent. Cable chain accommodates 2 power and 1 data cords.
- Height adjustment touch pad actuator options:
  - Single Stage Touch Pad Actuator available in Standard (E) up/down movement or Programmable (R) providing four different up/down programmed heights. Provides 27" (686mm) to 46" (1168mm) continuous height adjustment range.
  - Programmable Touch Pad Actuator:
    - Can be mounted on left or right side of table; predrilled for field installed and field changeable.
    - Touch pad actuator has touch pad controls and standard with black housing.
    - Control box is field installed and standard with black housing.
- Height adjustment: 1" (25mm) per 1.6 seconds.
- Telescoping base tubes and J-rails. Telescoping base tubes will match base trim color. Smooth paint trim will match. Textured paint will be complimentary.
- Includes: 9.5' (2895.6mm) long black power cord with NEMA 5-15P plug to the building.
- Base includes leg assembly and foot; available in painted trim colors.
- Glides have .5" (13mm) height adjustment and are standard in black.
- Grommets are available for field installation; separately specified.
- Ships unassembled.

### Specification Tips

- Designed to be used with one of the following separately specified 1.5H lower storage units:
  - 1.5H Attached Sliding Door Storage Unit for use with Convergent Worktop; available 23" (584mm)D, only.
  - 1.5H Attached Storage for use with Convergent Worktop - Open Unit; 18" (457mm)D or 23" (584mm).
- Separately specified Reinforcement Channel or Bar are not required.
- Not for use with 1.5H Attached Sliding Door Unit.
- One of the two Height Adjustable T-Legs is concealed within the full height raceway in the back of the 1.5H lower storage unit and the other is exposed.
- A separately specified Shroud for use with Height Adjustable T-Leg may be used as an aesthetic cover for the exposed Height Adjustable T-Leg.
- Trim Finish Recommendation: The bezel on the shroud and the convergent leg to be specified the same color.
- The bezel mounts to the credenza top on the 1.5H lower storage. Installation hole for bezel to be field cut.
- Convergent worktop (with or without a shroud) may be used with a separately specified Adaptable Modesty Panel.

### Electrical:

- For use with separately specified electrical components:
  - (Note: All of the options shown below require field cut mounting holes in the top. Ensure placement provides adequate clearance for table understructure.)
  - Flush Mounted Power Module Cord for Height Adjustable or Hardwire
  - Enhanced Power Module Corded or Hardwire with mounting bracket
  - Flip Top Unit Corded or Hardwire
  - Workware connect narrow non-switching interface module
  - Bezel Utility Module
- To limit cords connected to the building power use Power Modules with IEC connector.
- **Height Adjustable Convergent Worktop is not for use with AKP's, suspended or attached pedestals.**
- Worktop load capacity: 100 pounds
- Worktop load capacity (including top) and weight should be evenly distributed.
- Screen and Monitor Arm application:
  - 29" (737mm), 35" (889mm) and 41" (1041mm) deep table supports a 27" (686mm) high Belong screen and a monitor up to 50 lbs.

### To Order, Specify:

- 1) Product number, including:

#### 1 Surface Option:

- L** Laminate
- Z** Wood

#### 2 Edge Option:

- J** Edgeband (Laminate only)
- 1** Square (Wood only)

#### 3 Orientation Option:

- R** Right-hand
- L** Left-hand

#### 4 Height Adjustment Actuator Option:

Single Stage:

- E** Standard
- R** Programmable, add **\$187.41** list

- 2) Laminate surface color or wood finish color.
- 3) Edge trim color (laminate only).
- 4) Base trim color.

**Note:** **\$56.58** upcharge (list) for Metallic and accent trim colors.



# Masters Series

Convergent Worktop for use with 1.5H Storage — Rectangular with Column or Hoop

Depth	Width	Number			Laminate		Wood Group A	Wood Group B	
		①	②	③	A	B	Edge Options 1	Edge Options 1	5,6,7
<b>Column</b>									
30"(762mm)	60"(1524mm)	X	NR-3060-	SNC	\$1641.42	\$1784.63	\$2606.66	\$2658.81	\$2798.68
	66"(1676mm)	X	NR-3066-	SNC	1688.52	1831.73	2677.91	2731.41	2871.28
	72"(1829mm)	X	NR-3072-	SNC	1735.62	1878.83	2749.16	2804.01	2943.88
36"(914mm)	60"(1524mm)	X	NR-3660-	SNC	\$1735.62	\$1878.83	\$2749.16	\$2804.01	\$2943.88
	66"(1676mm)	X	NR-3666-	SNC	1792.14	1935.35	2834.66	2891.13	3031.00
	72"(1829mm)	X	NR-3672-	SNC	1848.66	1991.87	2920.16	2978.25	3118.12
	78"(1981mm)	X	NR-3678-	SNC	1905.18	2048.39	3005.66	3065.37	3205.24
	84"(2134mm)	X	NR-3684-	SNC	1961.70	2104.91	3091.16	3152.49	3292.36
42"(1067mm)	72"(1829mm)	X	NR-4272-	SNC	\$1961.70	\$2104.91	\$3091.16	\$3152.49	\$3292.36
	78"(1981mm)	X	NR-4278-	SNC	2027.64	2170.85	3190.91	3254.13	3394.00
	84"(2134mm)	X	NR-4284-	SNC	2093.58	2236.79	3290.66	3355.77	3495.64
<b>Hoop</b>									
30"(762mm)	60"(1524mm)	X	NR-3060-	SNH	\$1641.42	\$1784.63	\$2606.66	\$2658.81	\$2798.68
	66"(1676mm)	X	NR-3066-	SNH	1688.52	1831.73	2677.91	2731.41	2871.28
	72"(1829mm)	X	NR-3072-	SNH	1735.62	1878.83	2749.16	2804.01	2943.88
36"(914mm)	60"(1524mm)	X	NR-3660-	SNH	\$1735.62	\$1878.83	\$2749.16	\$2804.01	\$2943.88
	66"(1676mm)	X	NR-3666-	SNH	1792.14	1935.35	2834.66	2891.13	3031.00
	72"(1829mm)	X	NR-3672-	SNH	1848.66	1991.87	2920.16	2978.25	3118.12
	78"(1981mm)	X	NR-3678-	SNH	1905.18	2048.39	3005.66	3065.37	3205.24
	84"(2134mm)	X	NR-3684-	SNH	1961.70	2104.91	3091.16	3152.49	3292.36
42"(1067mm)	72"(1829mm)	X	NR-4272-	SNH	\$1961.70	\$2104.91	\$3091.16	\$3152.49	\$3292.36
	78"(1981mm)	X	NR-4278-	SNH	2027.64	2170.85	3190.91	3254.13	3394.00
	84"(2134mm)	X	NR-4284-	SNH	2093.58	2236.79	3290.66	3355.77	3495.64

## Convergent Worktop for use with 1.5H Storage — Rectangular with Column or Hoop

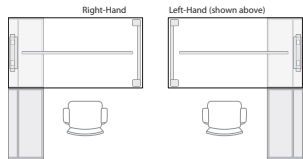
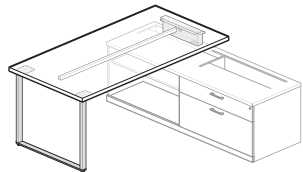
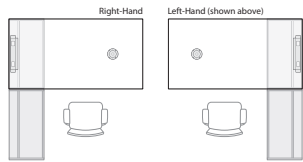
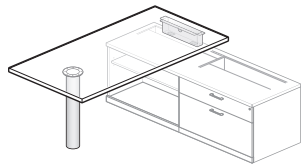

XLNR-3072  
XZNR-3072

### Features

- Includes 1.1875"(36mm) thick worktop, one column or hoop, stanchion and attachment hardware.
- Reinforcement Bar added to 72"(1829mm), 78"(1981mm) and 84"(2134mm) worktop with hoop leg.
- 1.1875"(30mm) thick laminate worktop with 3mm edgeband applied to user and visitor edges. Ends capped with 1mm thick edgeband.
- 1.1875"(30mm) thick wood worktop with a choice of profiled edge (Square, Bevel, Radius or Traditional) applied to user and visitor edges. Double-cut veneers available with Square 3mm Radius edge only.
- Glides have .5"(13mm) height adjustment and are standard in black.
- Grommets are available for field installation; separately specified.
- Depth and width shown in nominal dimensions.
- Ships unassembled.

### Specification Tips

- Must be attached to a 1.5H lower storage unit; 18"(457mm) or 23"(584mm) deep.
- The stanchion is typically positioned above the back raceway of the 1.5H lower storage.
- The stanchion mounts to a separately specified credenza top.
- Stanchion screws to credenza top; field installed. See Specification Guide for location details.
- May be used with separately specified Adaptable Modesty Panel.

### Electrical:

- For use with separately specified electrical components: (Note: All of the options shown below require field cut mounting holes in the top. Ensure placement provides adequate clearance for table understructure.)
  - Flush Mounted Power Module with Plug or Hardwire
  - Enhanced Power Module Corded or Hardwire
  - Flip Top Unit Corded or Hardwire
  - Workware connect narrow non-switching interface module
  - Bezel Utility Module

### To Order, Specify:

- 1) Product number, including:

#### ① Surface Option:

- L** Laminate
- Z** Wood

#### ② Edge Option:

- J** Edgeband (Laminate only)
- 1** Square (Wood only)
- 5** Bevel (Wood only)
- 6** Radius (Wood only)
- 7** Traditional (Wood only)

#### ③ Column or Hoop Leg Finish:

- B** Paint
- C** Chrome Column, add **\$386.96** list  
Chrome Hoop, add **\$516.39** list

**Note:** Chrome leg will have Metallic Silver stanchion (TR-LE).

- 2) Laminate surface color or wood finish color.
- 3) Edge trim color (laminate only).
- 4) Base trim color.

**Note:** **\$56.58** upcharge (list) for Metallic and accent trim colors.

# Masters Series

Convergent Worktop for use with 1.5H Storage — Wedge Square with Column or Hoop

Depth	Width	Number				Laminate A	B	Wood Group A	Wood Group B	5,6,7
		1	2	3	4			Edge Options 1	Edge Options 1	
<b>Column</b>										
42"(1067mm)	60"(1524mm)	X	NW-4260-	S	C	\$1656.91	\$1800.12	\$3178.09	\$3263.19	\$3403.06
	66"(1676mm)	X	NW-4266-	S	C	1722.85	1866.06	3277.84	3364.83	3504.70
	72"(1829mm)	X	NW-4272-	S	C	1788.79	1932.00	3377.59	3466.47	3606.34
	78"(1981mm)	X	NW-4278-	S	C	1854.73	1997.94	3477.34	3568.11	3707.98
	84"(2134mm)	X	NW-4284-	S	C	1920.67	2063.88	3577.09	3669.75	3809.62
48"(1219mm)	60"(1524mm)	X	NW-4860-	S	C	\$1751.11	\$1894.32	\$3320.59	\$3408.39	\$3548.26
	66"(1676mm)	X	NW-4866-	S	C	1826.47	1969.68	3434.59	3524.55	3664.42
	72"(1829mm)	X	NW-4872-	S	C	1901.83	2045.04	3548.59	3640.71	3780.58
	78"(1981mm)	X	NW-4878-	S	C	1977.19	2120.40	3662.59	3756.87	3896.74
	84"(2134mm)	X	NW-4884-	S	C	2052.55	2195.76	3776.59	3873.03	4012.90
<b>Hoop</b>										
42"(1067mm)	60"(1524mm)	X	NW-4260-	S	H	\$1656.91	\$1800.12	\$3178.09	\$3263.19	\$3403.06
	66"(1676mm)	X	NW-4266-	S	H	1722.85	1866.06	3277.84	3364.83	3504.70
	72"(1829mm)	X	NW-4272-	S	H	1788.79	1932.00	3377.59	3466.47	3606.34
	78"(1981mm)	X	NW-4278-	S	H	1854.73	1997.94	3477.34	3568.11	3707.98
	84"(2134mm)	X	NW-4284-	S	H	1920.67	2063.88	3577.09	3669.75	3809.62
48"(1219mm)	60"(1524mm)	X	NW-4860-	S	H	\$1751.11	\$1894.32	\$3320.59	\$3408.39	\$3548.26
	66"(1676mm)	X	NW-4866-	S	H	1826.47	1969.68	3434.59	3524.55	3664.42
	72"(1829mm)	X	NW-4872-	S	H	1901.83	2045.04	3548.59	3640.71	3780.58
	78"(1981mm)	X	NW-4878-	S	H	1977.19	2120.40	3662.59	3756.87	3896.74
	84"(2134mm)	X	NW-4884-	S	H	2052.55	2195.76	3776.59	3873.03	4012.90

**Convergent Worktop for use with 1.5H Storage — Wedge Square with Column or Hoop**

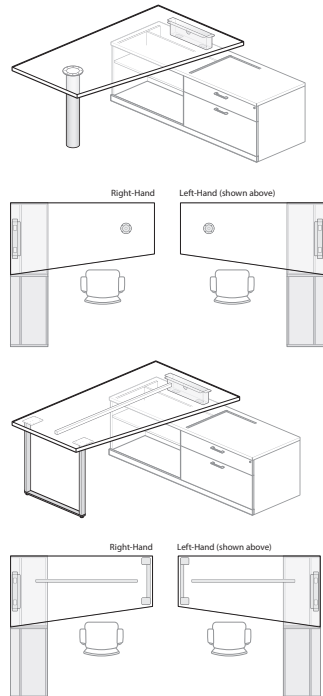

XLNW-4272  
XZNW-4272

**Features**

- Includes 1.1875"(36mm) thick worktop, one column or hoop, stanchion and attachment hardware.
- Reinforcement Bar added to 72"(1829mm), 78"(1981mm) and 84"(2134mm) worktop with hoop leg.
- 1.1875"(30mm) thick laminate worktop with 3mm edgeband applied to user and visitor edges. Ends capped with 1mm thick edgeband.
- 1.1875"(30mm) thick wood worktop with a choice of profiled edge (Square, Bevel, Radius or Traditional) applied to user and visitor edges. Double-cut veneers available with Square 3mm Radius edge only.
- Glides have .5"(13mm) height adjustment and are standard in black.
- Grommets are available for field installation; separately specified.
- Depth and width shown in nominal dimensions.
- Ships unassembled.

**Specification Tips**

- Must be attached to a 1.5H lower storage unit; 18"(457mm) or 23"(584mm) deep.
- The stanchion is typically positioned above the back raceway of the 1.5H lower storage.
- The stanchion mounts to a separately specified credenza top.
- Stanchion screws to credenza top; field installed. See Specification Guide for location details.
- May be used with separately specified Adaptable Modesty Panel.

**Electrical:**

- For use with separately specified electrical components: (Note: All of the options shown below require field cut mounting holes in the top. Ensure placement provides adequate clearance for table understructure.)
  - Flush Mounted Power Module with Plug or Hardwire
  - Enhanced Power Module Corded or Hardwire
  - Flip Top Unit Corded or Hardwire
  - Workware connect narrow non-switching interface module
  - Bezel Utility Module

**To Order, Specify:**

1) Product number, including:

**1 Surface Option:**

- L** Laminate
- Z** Wood

**2 Edge Option:**

- J** Edgeband (Laminate only)
- 1** Square (Wood only)
- 5** Bevel (Wood only)
- 6** Radius (Wood only)
- 7** Traditional (Wood only)

**3 Orientation Option:**

- R** Right-hand
- L** Left-hand Column or Hoop Leg Finish:

**4 Column or Hoop Leg Finish:**

- B** Paint
- C** Chrome Column, add \$386.96 list  
Chrome Hoop, add \$516.39 list

**Note:** Chrome leg will have Metallic Silver stanchion (TR-LE).

- 2) Laminate surface color or wood finish color.
- 3) Edge trim color (laminate only).
- 4) Base trim color.

**Note:** \$56.58 upcharge (list) for Metallic and accent trim colors.

# Masters Series

Convergent Worktop for use with 1.5H Storage — Wedge Radius with Column or Hoop

Depth	Width	Number ① ② ③ ④	Laminate		Wood Group A	Wood Group B
			A	B	Edge Options 1	Edge Options 1
<b>Column</b>						
42"(1067mm)	60"(1524mm)	X ■ NG-4260- ■ S ■ C ■	\$1808.40	\$1951.61	\$3330.86	\$3416.04
	66"(1676mm)	X ■ NG-4266- ■ S ■ C ■	1874.34	2017.55	3430.61	3517.68
	72"(1829mm)	X ■ NG-4272- ■ S ■ C ■	1940.28	2083.49	3530.36	3619.32
	78"(1981mm)	X ■ NG-4278- ■ S ■ C ■	2006.22	2149.43	3630.11	3720.96
	84"(2134mm)	X ■ NG-4284- ■ S ■ C ■	2072.16	2215.37	3729.86	3822.60
48"(1219mm)	60"(1524mm)	X ■ NG-4860- ■ S ■ C ■	\$1902.60	\$2045.81	\$3473.36	\$3561.24
	66"(1676mm)	X ■ NG-4866- ■ S ■ C ■	1977.96	2121.17	3587.36	3677.40
	72"(1829mm)	X ■ NG-4872- ■ S ■ C ■	2053.32	2196.53	3701.36	3793.56
	78"(1981mm)	X ■ NG-4878- ■ S ■ C ■	2128.68	2271.89	3815.36	3909.72
	84"(2134mm)	X ■ NG-4884- ■ S ■ C ■	2204.04	2347.25	3929.36	4025.88
<b>Hoop</b>						
42"(1067mm)	60"(1524mm)	X ■ NG-4260- ■ S ■ H ■	\$1808.40	\$1951.61	\$3330.86	\$3416.04
	66"(1676mm)	X ■ NG-4266- ■ S ■ H ■	1874.34	2017.55	3430.61	3517.68
	72"(1829mm)	X ■ NG-4272- ■ S ■ H ■	1940.28	2083.49	3530.36	3619.32
	78"(1981mm)	X ■ NG-4278- ■ S ■ H ■	2006.22	2149.43	3630.11	3720.96
	84"(2134mm)	X ■ NG-4284- ■ S ■ H ■	2072.16	2215.37	3729.86	3822.60
48"(1219mm)	60"(1524mm)	X ■ NG-4860- ■ S ■ H ■	\$1902.60	\$2045.81	\$3473.36	\$3561.24
	66"(1676mm)	X ■ NG-4866- ■ S ■ H ■	1977.96	2121.17	3587.36	3677.40
	72"(1829mm)	X ■ NG-4872- ■ S ■ H ■	2053.32	2196.53	3701.36	3793.56
	78"(1981mm)	X ■ NG-4878- ■ S ■ H ■	2128.68	2271.89	3815.36	3909.72
	84"(2134mm)	X ■ NG-4884- ■ S ■ H ■	2204.04	2347.25	3929.36	4025.88

## Convergent Worktop for use with 1.5H Storage — Wedge Radius with Column or Hoop

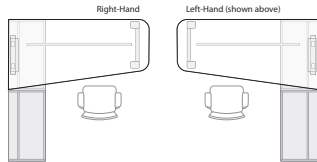
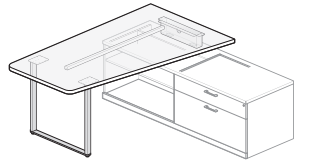
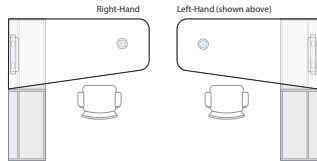
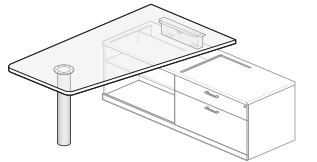

XLNG-4272  
XZNG-4272

### Features

- Includes 1.1875"(36mm) thick worktop, one column or hoop, stanchion and attachment hardware.
- Reinforcement Bar added to 72"(1829mm), 78"(1981mm) and 84"(2134mm) worktop with hoop leg.
- 1.1875"(30mm) thick laminate worktop with 3mm edgeband applied to user and visitor edges. Ends capped with 1mm thick edgeband.
- 1.1875"(30mm) thick wood worktop with a choice of profiled edge (Square, Bevel, Radius or Traditional) applied to user and visitor edges. Double-cut veneers available with Square 3mm Radius edge only.
- Glides have .5"(13mm) height adjustment and are standard in black.
- Grommets are available for field installation; separately specified.
- Depth and width shown in nominal dimensions.
- Ships unassembled.

### Specification Tips

- Must be attached to a 1.5H lower storage unit; 18"(457mm) or 23"(584mm) deep.
- The stanchion is typically positioned above the back raceway of the 1.5H lower storage.
- The stanchion mounts to a separately specified credenza top.
- Stanchion screws to credenza top; field installed. See Specification Guide for location details.
- May be used with separately specified Adaptable Modesty Panel.

### Electrical:

- For use with separately specified electrical components: (Note: All of the options shown below require field cut mounting holes in the top. Ensure placement provides adequate clearance for table understructure.)
  - Flush Mounted Power Module with Plug or Hardwire
  - Enhanced Power Module Corded or Hardwire
  - Flip Top Unit Corded or Hardwire
  - Workware connect narrow non-switching interface module
  - Bezel Utility Module

### Wood Group A Edge Options

### Wood Group B Edge Options

### To Order, Specify:

- 1) Product number, including:

#### ① Surface Option:

- L** Laminate
- Z** Wood

#### ② Edge Option:

- J** Edgeband (Laminate only)
- 1** Square (Wood only)

#### ③ Orientation Option:

- R** Right-hand
- L** Left-hand

#### ④ Column or Hoop Leg Finish:

- B** Paint
- C** Chrome Column, add **\$386.96** list  
Chrome Hoop, add **\$516.39** list

**Note:** Chrome leg will have Metallic Silver stanchion (TR-LE).

- 2) Laminate surface color or wood finish color.
- 3) Edge trim color (laminate only).
- 4) Base trim color.

**Note:** **\$56.58** upcharge (list) for Metallic and accent trim colors.



# Masters Series

Shroud for use with Height Adjustable T-Leg

For Use With	Nominal Width	Actual Width	Number ①	Laminate		Wood Group		
				A	B	A	B	
<b>Single</b>								
	30"(762mm)	24"(610mm)	X	S1-3000-SE	\$1096.69	\$1144.30	\$1489.26	\$1512.26
	36"(914mm)	30"(762mm)	X	S1-3600-SE	1139.80	1187.70	1599.21	1626.22
	42"(1067mm)	36"(914mm)	X	S1-4200-SE	1182.91	1231.10	1709.16	1740.18
<b>Pair</b>								
	30"(762mm)	24"(610mm)	X	S2-3000-SE	\$2193.38	\$2288.60	\$2978.52	\$3024.52
	36"(914mm)	30"(762mm)	X	S2-3600-SE	2279.60	2375.40	3198.42	3252.44
	42"(1067mm)	36"(914mm)	X	S2-4200-SE	2365.82	2462.20	3418.32	3480.36

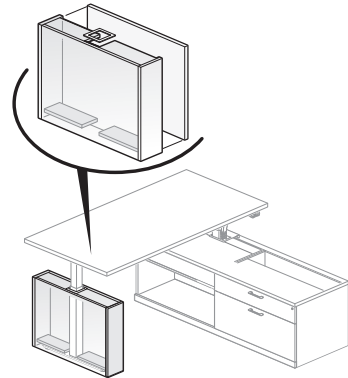

Shown with:  
Height Adjustable Convergent Worktop

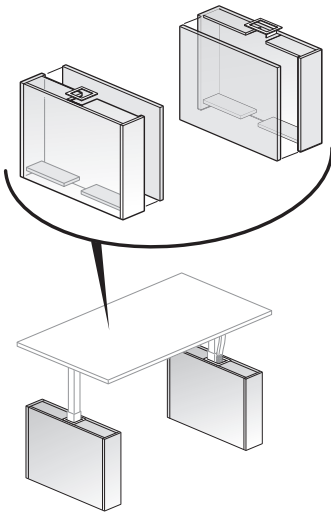

Shown with:  
Height Adjustable Table Desk

XLS1-3060  
XZS1-3060

### Features

- Include:
  - Single Shroud, bezel and attachment hardware.
  - Pair of Shrouds, bezel, cable chain bracket, cable chain and attachment hardware.
- Shroud (s) are finished on all sides and top.

### Specification Tips

- For use with the following:
  - Height Adjustable Table Desk Rectangular Top - T-Leg Base (pair of shrouds)
  - Height Adjustable Convergent Worktop- T-Leg (single shroud)
    - Rectangular
    - Wedge Square
    - Wedge Radius
- Not for use with the Height Adjustable Credenza Desk-Rectangular -T-Leg Base; dimensionally different shroud.
- A pair of shrouds will accept a separately specified Modesty Panel for Shroud.

### To Order, Specify:

- 1) Product number, including:

#### ① Surface Option:

- L** Laminate
- Z** Wood

- 2) Laminate surface color or wood finish color.
- 3) Edge trim color (laminated only).
- 4) Bezel trim color (color should match the base color of the table).

# Masters Series

## Modesty Panel for Shroud

Height	Width	Number	Laminate A	B	Wood Group A	Wood Group B
<b>Laminate</b>						
22"(559mm)	60"(1524mm)	XLXS-2260	\$394.78	\$425.82	N/A	N/A
	66"(1676mm)	XLXS-2266	425.92	461.32	N/A	N/A
	72"(1829mm)	XLXS-2272	457.06	496.82	N/A	N/A
	78"(1981mm)	XLXS-2278	488.20	532.32	N/A	N/A
	84"(2134mm)	XLXS-2284	519.34	567.82	N/A	N/A
<b>Wood</b>						
22"(559mm)	60"(1524mm)	XZXS-2260	N/A	N/A	\$ 833.86	\$ 863.99
	66"(1676mm)	XZXS-2266	N/A	N/A	893.00	926.69
	72"(1829mm)	XZXS-2272	N/A	N/A	952.14	989.39
	78"(1981mm)	XZXS-2278	N/A	N/A	1011.28	1052.09
	84"(2134mm)	XZXS-2284	N/A	N/A	1070.42	1114.79

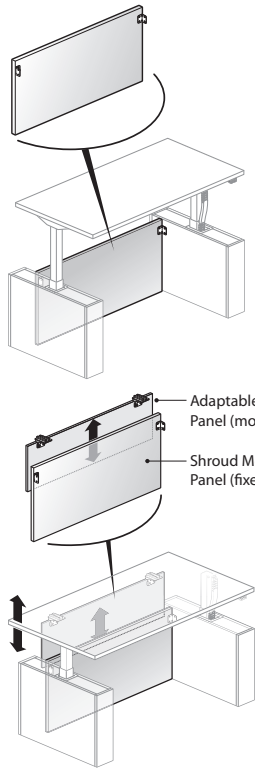

XLXS-2260  
XZXS-2260

### Features

- Includes modesty panel and attachment hardware.
- Modesty Panels are 22.4"(569mm) high (actual) and .75"(19mm) thick.
- Modesty Panels are mounted between the pair of shrouds.
- Panel and hardware are field installed.

### Specification Tips

- For use on Height Adjustable Table Desk with a pair of shrouds.
- Specify Modesty Panel for Shroud the same width as the Height Adjustable Table Desk.
- A Height Adjustable Table Desk with a pair of shrouds may be used with either a Modesty Panel for Shroud or an Adaptable Modesty Panel or both modesty panels may be used together in a layered application:
  - The Modesty Panel for Shroud is installed inboard of the Adaptable Modesty panel.
  - The Modesty Panel for Shroud is stationary and provides modesty between the pair of shrouds.
  - The Adaptable Modesty Panel is attached to the underside of the desk and provides height adjustable modesty when the desk is raised or lowered.
  - When the Table Desk is raised to full height a 9"(229mm) gap between panels.

**Note:** To specify an Adaptable Modesty Panel refer to the **Modesty Panel for use with Shroud Specification Matrix for the appropriate width Adaptable Modesty Panel** - shown on the Adaptable Modesty Panel page.

### To Order, Specify:

- 1) Product number.
- 2) Laminate or wood finish.
- 3) Edge trim color (laminate only).

## Masters Series

Convergent T-Worktop – Rectangular

Height	Depth	Width	Number ① ②	Laminate		Wood Group A	Group B	
				A	B			
<b>Laminate</b>								
29.125"(740mm)	30"(762mm)	48"(1219mm)	XLTH-3048-JSNF		\$2094.54	\$2301.16		
		54"(1372mm)	XLTH-3054-JSNF		2165.64	2380.11		
		60"(1524mm)	XLTH-3060-JSNF		2236.74	2459.06		
		66"(1676mm)	XLTH-3066-JSNF		2307.84	2538.01		
		72"(1829mm)	XLTH-3072-JSNF		2378.94	2616.96		
		78"(1981mm)	XLTH-3078-JSNF		2450.04	2695.91		
		36"(914mm)	48"(1219mm)	XLTH-3648-JSNF		\$2208.30	\$2427.48	
	54"(1372mm)	XLTH-3654-JSNF		2293.62	2522.22			
	60"(1524mm)	XLTH-3660-JSNF		2378.94	2616.96			
	66"(1676mm)	XLTH-3666-JSNF		2464.26	2711.70			
	72"(1829mm)	XLTH-3672-JSNF		2549.58	2806.44			
	78"(1981mm)	XLTH-3678-JSNF		2634.90	2901.18			
	<b>Wood</b>							
	29.125"(740mm)	30"(762mm)	48"(1219mm)	XZTH-3048-	SSF		\$3198.32	\$3566.26
54"(1372mm)			XZTH-3054-	SSF		3312.67	3692.11	
60"(1524mm)			XZTH-3060-	SSF		3427.02	3817.96	
66"(1676mm)			XZTH-3066-	SSF		3541.37	3943.81	
72"(1829mm)			XZTH-3072-	SSF		3655.72	4069.66	
78"(1981mm)			XZTH-3078-	SSF		3770.07	4195.51	
36"(914mm)			48"(1219mm)	XZTH-3648-	SSF	\$3381.28	\$3767.62	
54"(1372mm)		XLTH-3654-	SSF		3518.50	3918.64		
60"(1524mm)		XZTH-3660-	SSF		3655.72	4069.66		
66"(1676mm)		XZTH-3666-	SSF		3792.94	4220.68		
72"(1829mm)		XZTH-3672-	SSF		3930.16	4371.70		
78"(1981mm)		XZTH-3678-	SSF		4067.38	4522.72		

## Convergent T-Worktop – Rectangular

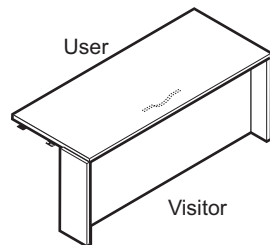
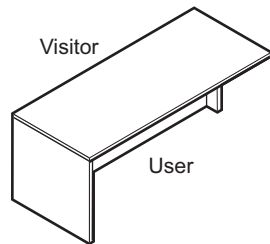

XLTH-FL  
XZTH-FL  
(Left-hand shown)

## Features

- Includes worktop, case, one end panel, one 10.125"(257mm) deep light-block panel and attachment hardware.
- 1.1875"(30mm) thick laminate worktop with 3mm edgeband applied to user and visitor edges only. Ends capped with 1mm thick edgeband. All other components finished in laminate with 1mm thick edgeband.
- 1.1875"(30mm) thick wood worktop with a choice of profiled edge (Square, Bevel, Radius or Traditional) applied to user and visitor edges. Double-cut veneers available with Square 3mm Radius edge only.
- Attachment edge of wood veneer worktops with Bevel, Radius and Traditional profiled edges is coped.
- Full modesty panel recessed 6"(152mm) for visitor side overhang.
- Unfinished clearcoat wireway scallop in top center of modesty panel.
- Glides provide 2"(51mm) adjustment range.
- Shipped unassembled.

## Specification Tips

- Handed design (left or right) based on position of attachment side.
- Not designed to stand alone.
- Two flat brackets to allow for attachment to modular credenza.
- Does not accommodate separately specified attached 2H storage.
- Accommodates separately specified center drawer.
- Separately specified grommets can be field installed in convergent worktop.

## To Order, Specify:

- 1) Product number, including:

## ① Edge Option:

Wood:

- 1 Square
- 5 Bevel, starting \$236.18\* add to list
- 6 Radius, starting \$236.18\* add to list
- 7 Traditional, starting \$236.18\* add to list

## ② Orientation:

- L Left-hand
- R Right-hand

- 2) Finish code for lower components (laminate or wood).
- 3) Laminate edge trim for lower components (if laminate option specified).
- 4) Laminate worktop color (if laminate option specified).
- 5) Laminate edge trim for worktop (if laminate option specified).

**Note:** Wood grained laminate worktop finishes are applied with wood grain direction side-to-side only.

\*Additional upcharge based on size. Use design and specification tools for pricing.

This page intentionally blank

# Masters Series

## Convergent D-Worktop with T-Support and Column

### Convergent D-Worktop with T-Support and Column

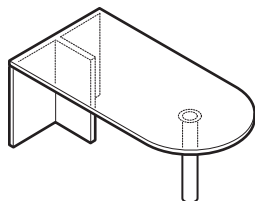

XLYD-SF  
XZYD-SF  
48"-96" widths

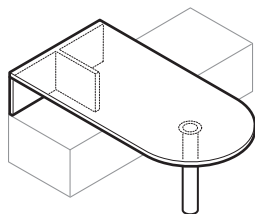

XLYD-SP  
XZYD-SP  
72"-96" widths

### Features

- Includes worktop, T-support end panel, column leg and column leg attachment hardware.
- 1.1875"(30mm) thick laminate worktop with 3mm edgeband applied to user and visitor edges only. Ends capped with 1mm thick edgeband. All other components finished in laminate with 1mm thick edgeband.
- 1.1875"(30mm) thick wood worktop with a choice of profiled edge (Square, Bevel, Radius or Traditional) applied to user and visitor edges. Double-cut veneers available with Square 3mm Radius edge only.
- Partial height end panel available on 72"(1829mm)-96"(2438mm) wide tops.
- 4"(102mm) diameter column leg with 3"(76mm) adjustment.
- Shipped unassembled.

### Specification Tips

- Not designed to stand alone.
- See Stack-on Application Rules in Specification Guide.
- Desk with partial height end panel to be supported on one-high modular bench.
- Accommodates separately specified center drawer.
- Separately specified grommets can be field installed in desk worksurface.
- See 1H Application Rules in Specification Guide.

### To Order, Specify:

- 1) Product number, including:

#### ① Edge Option:

Wood:

- 1** Square
- 5** Bevel
- 6** Radius
- 7** Traditional

- 2) Finish code for T-support (laminate or wood).
- 3) Laminate edge trim for T-support (if laminate option specified).
- 4) Laminate worktop color (if laminate option specified).
- 5) Laminate edge trim for worktop (if laminate option specified).
- 6) Column trim color (required).

**Note:** \$386.96 upcharge (list) for optional chrome column trim.

**Note:** Wood grained laminate worktop finishes are applied with wood grain direction side-to-side only.

# Masters Series

Convergent D-Worktop with T-Support and Column

Depth	Width	Number ① ②	Laminate	
			A	B
<b>Partial Height</b>				
30"(762mm)	72"(1829mm)	XLYD-3072-JSNNP	\$1407.54	\$1693.35
	78"(1981mm)	XLYD-3078-JSNNP	1454.19	1789.65
	84"(2134mm)	XLYD-3084-JSNNP	1500.84	1885.95
	90"(2286mm)	XLYD-3090-JSNNP	1547.49	1982.25
36"(914mm)	72"(1829mm)	XLYD-3672-JSNNP	\$1519.50	\$1924.47
	78"(1981mm)	XLYD-3678-JSNNP	1575.48	2040.03
	84"(2134mm)	XLYD-3684-JSNNP	1631.46	2155.59
	90"(2286mm)	XLYD-3690-JSNNP	1687.44	2271.15
	96"(2438mm)	XLYD-3696-JSNNP	1743.42	2386.71
<b>Full Height</b>				
30"(762mm)	48"(1219mm)	XLYD-3048-JSNNF	\$1438.15	\$1525.36
	54"(1372mm)	XLYD-3054-JSNNF	1484.80	1621.66
	60"(1524mm)	XLYD-3060-JSNNF	1531.45	1717.96
	66"(1676mm)	XLYD-3066-JSNNF	1578.10	1814.26
	72"(1829mm)	XLYD-3072-JSNNF	1624.75	1910.56
	78"(1981mm)	XLYD-3078-JSNNF	1671.40	2006.86
	84"(2134mm)	XLYD-3084-JSNNF	1718.05	2103.16
	90"(2286mm)	XLYD-3090-JSNNF	1764.70	2199.46
	36"(914mm)	48"(1219mm)	XLYD-3648-JSNNF	\$1512.79
54"(1372mm)		XLYD-3654-JSNNF	1568.77	1795.00
60"(1524mm)		XLYD-3660-JSNNF	1624.75	1910.56
66"(1676mm)		XLYD-3666-JSNNF	1680.73	2026.12
72"(1829mm)		XLYD-3672-JSNNF	1736.71	2141.68
78"(1981mm)		XLYD-3678-JSNNF	1792.69	2257.24
84"(2134mm)		XLYD-3684-JSNNF	1848.67	2372.80
90"(2286mm)		XLYD-3690-JSNNF	1904.65	2488.36
96"(2438mm)		XLYD-3696-JSNNF	1960.63	2603.92

Depth	Width	Number ①	Wood Group A	Wood Group B	
			Edge Options 1	Edge Options 1	5,6,7
<b>Partial Height</b>					
30"(762mm)	72"(1829mm)	XZYD-3072-■ SNSP	\$3071.71	\$3394.13	\$4013.56
	78"(1981mm)	XZYD-3078-■ SNSP	3188.86	3521.63	4141.06
	84"(2134mm)	XZYD-3084-■ SNSP	3306.01	3649.13	4268.56
	90"(2286mm)	XZYD-3090-■ SNSP	3423.16	3776.63	4396.06
36"(914mm)	72"(1829mm)	XZYD-3672-■ SNSP	\$3352.87	\$3700.13	\$4319.56
	78"(1981mm)	XZYD-3678-■ SNSP	3493.45	3853.13	4472.56
	84"(2134mm)	XZYD-3684-■ SNSP	3634.03	4006.13	4625.56
	90"(2286mm)	XZYD-3690-■ SNSP	3774.61	4159.13	4778.56
	96"(2438mm)	XZYD-3696-■ SNSP	3915.19	4312.13	4931.56
<b>Full Height</b>					
30"(762mm)	48"(1219mm)	XZYD-3048-■ SNSF	\$2820.32	\$3101.34	\$3454.79
	54"(1372mm)	XZYD-3054-■ SNSF	2937.47	3228.84	3582.29
	60"(1524mm)	XZYD-3060-■ SNSF	3054.62	3356.34	3709.79
	66"(1676mm)	XZYD-3066-■ SNSF	3171.77	3483.84	4103.27
	72"(1829mm)	XZYD-3072-■ SNSF	3288.92	3611.34	4230.77
	78"(1981mm)	XZYD-3078-■ SNSF	3406.07	3738.84	4358.27
	84"(2134mm)	XZYD-3084-■ SNSF	3523.22	3866.34	4485.77
	90"(2286mm)	XZYD-3090-■ SNSF	3640.37	3993.84	4613.27
	36"(914mm)	48"(1219mm)	XZYD-3648-■ SNSF	\$3007.76	\$3305.34
54"(1372mm)		XZYD-3654-■ SNSF	3148.34	3458.34	3811.79
60"(1524mm)		XZYD-3660-■ SNSF	3288.92	3611.34	3964.79
66"(1676mm)		XZYD-3666-■ SNSF	3429.50	3764.34	4383.77
72"(1829mm)		XZYD-3672-■ SNSF	3570.08	3917.34	4536.77
78"(1981mm)		XZYD-3678-■ SNSF	3710.66	4070.34	4689.77
84"(2134mm)		XZYD-3684-■ SNSF	3851.24	4223.34	4842.77
90"(2286mm)		XZYD-3690-■ SNSF	3991.82	4376.34	4995.77
96"(2438mm)		XZYD-3696-■ SNSF	4132.40	4529.34	5148.77

# Masters Series

## Convergent P-Worktop with T-Support and Column

### Convergent P-Worktop with T-Support and Column

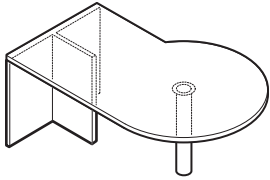

(Right-hand shown)

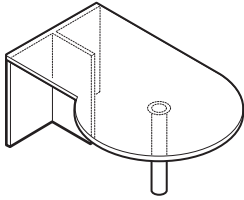
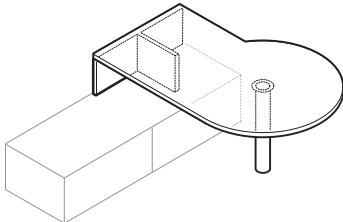
 XLYP-SF  
 XZYP-SF  
 (Left-hand shown)

(Right-hand shown)

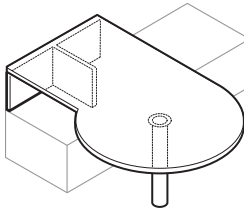
 XLYP-SP  
 XZYP-SP  
 (Left-hand shown)

### Features

- Includes worktop, T-support end panel, column leg and column leg attachment hardware.
- 1.1875"(30mm) thick laminate worktop with 3mm edgeband applied to user and visitor edges only. Ends capped with 1mm thick edgeband. All other components finished in laminate with 1mm thick edgeband.
- 1.1875"(30mm) thick wood worktop with a choice of profiled edge (Square, Bevel, Radius or Traditional) applied to user and visitor edges. Double-cut veneers available with Square 3mm Radius edge only.
- Optional end panel height available on desks 72"(1829mm) or greater in width.
- 4"(102mm) column leg with 3"(76mm) adjustment.
- Shipped unassembled.

### Specification Tips

- Not designed to stand alone.
- 30"(762mm) deep worktop has 42"(1067mm) diameter conference end, handed with radius extending away from user.
- 36"(914mm) deep worktop has 48"(1219mm) diameter conference end, handed with radius extending away from user.
- See Stack-on Application Rules in Specification Guide.
- Desk with partial height end panel to be supported on 1H modular bench.
- Accommodates separately specified center drawer.
- Separately specified grommets can be field installed in desk worktop.
- See 1H Application Rules in Specification Guide.

### To Order, Specify:

- 1) Product number, including:

#### 1 Edge Option:

Wood:

- 1** Square
- 5** Bevel
- 6** Radius
- 7** Traditional

#### 2 Orientation:

- L** Left-hand
- R** Right-hand

- 2) Finish code for T-support (laminate or wood).
- 3) Laminate edge trim for T-support (if laminate option specified).
- 4) Laminate worktop color (if laminate option specified).
- 5) Laminate edge trim for worktop (if laminate option specified).
- 6) Column trim color (required).

**Note:** \$386.96 upcharge (list) for optional chrome column trim.

**Note:** Wood grained laminate worktop finishes are applied with wood grain direction side-to-side only.

# Masters Series

Convergent P-Worktop with T-Support and Column

Depth	Width	Number ① ②	Laminate	
			A	B
<b>Partial Height</b>				
30"(762mm)	72"(1829mm)	XLYP-3072-JS NP	\$1676.24	\$1847.88
	78"(1981mm)	XLYP-3078-JS NP	1732.17	1908.36
	84"(2134mm)	XLYP-3084-JS NP	1788.10	1968.84
	90"(2286mm)	XLYP-3090-JS NP	1844.03	2029.32
36"(914mm)	78"(1981mm)	XLYP-3678-JS NP	\$1836.04	\$2020.68
	84"(2134mm)	XLYP-3684-JS NP	1899.96	2089.80
	90"(2286mm)	XLYP-3690-JS NP	1963.88	2158.92
	96"(2438mm)	XLYP-3696-JS NP	2027.80	2228.04
<b>Full Height</b>				
30"(762mm)	54"(1372mm)	XLYP-3054-JS NF	\$1712.26	\$1870.25
	60"(1524mm)	XLYP-3060-JS NF	1768.19	1930.73
	66"(1676mm)	XLYP-3066-JS NF	1824.12	1991.21
	72"(1829mm)	XLYP-3072-JS NF	1880.05	2051.69
	78"(1981mm)	XLYP-3078-JS NF	1935.98	2112.17
	84"(2134mm)	XLYP-3084-JS NF	1991.91	2172.65
	90"(2286mm)	XLYP-3090-JS NF	2047.84	2233.13
	36"(914mm)	66"(1676mm)	XLYP-3666-JS NF	\$1912.01
72"(1829mm)		XLYP-3672-JS NF	1975.93	2155.37
78"(1981mm)		XLYP-3678-JS NF	2039.85	2224.49
84"(2134mm)		XLYP-3684-JS NF	2103.77	2293.61
90"(2286mm)		XLYP-3690-JS NF	2167.69	2362.73
96"(2438mm)		XLYP-3696-JS NF	2231.61	2431.85

Depth	Width	Number ① ②	Wood Group A	Wood Group B	
			Edge Options 1	Edge Options 1	5,6,7
<b>Partial Height</b>					
30"(762mm)	72"(1829mm)	XZYP-3072- S SP	\$3612.61	\$3987.35	\$4583.38
	78"(1981mm)	XZYP-3078- S SP	3841.79	4231.72	4827.75
	84"(2134mm)	XZYP-3084- S SP	4070.97	4476.09	5072.12
	90"(2286mm)	XZYP-3090- S SP	4300.15	4720.46	5316.49
36"(914mm)	78"(1981mm)	XZYP-3678- S SP	\$4267.41	\$4685.55	\$5281.58
	84"(2134mm)	XZYP-3684- S SP	4529.33	4964.83	5560.86
	90"(2286mm)	XZYP-3690- S SP	4791.25	5244.11	5840.14
	96"(2438mm)	XZYP-3696- S SP	5053.17	5523.39	6119.42
<b>Full Height</b>					
30"(762mm)	54"(1372mm)	XZYP-3054- S SF	\$3128.88	\$3458.05	\$3798.17
	60"(1524mm)	XZYP-3060- S SF	3358.06	3702.42	4042.54
	66"(1676mm)	XZYP-3066- S SF	3587.24	3946.79	4542.82
	72"(1829mm)	XZYP-3072- S SF	3816.42	4191.16	4787.19
	78"(1981mm)	XZYP-3078- S SF	4045.60	4435.53	5031.56
	84"(2134mm)	XZYP-3084- S SF	4274.78	4679.90	5275.93
	90"(2286mm)	XZYP-3090- S SF	4503.96	4924.27	5520.30
	36"(914mm)	66"(1676mm)	XZYP-3666- S SF	\$3947.38	\$4330.80
72"(1829mm)		XZYP-3672- S SF	4209.30	4610.08	5206.11
78"(1981mm)		XZYP-3678- S SF	4471.22	4889.36	5485.39
84"(2134mm)		XZYP-3684- S SF	4733.14	5168.64	5764.67
90"(2286mm)		XZYP-3690- S SF	4995.06	5447.92	6043.95
96"(2438mm)		XZYP-3696- S SF	5256.98	5727.20	6323.23



## Masters Series

Convergent D-Worktop with Column

Height	Depth	Width	Number ①	Laminate		Wood Group A	Wood Group B	
				A	B	Edge Options 1	Edge Options 1	5,6,7
<b>Laminate</b>								
29.125"(740mm)	30"(762mm)	30"(762mm)	XLND-3030-JSNN	\$ 729.26	\$ 787.63			
		36"(914mm)	XLND-3036-JSNN	764.76	825.98			
		42"(1067mm)	XLND-3042-JSNN	800.26	864.33			
		48"(1219mm)	XLND-3048-JSNN	835.76	902.68			
		54"(1372mm)	XLND-3054-JSNN	871.26	941.03			
		60"(1524mm)	XLND-3060-JSNN	906.76	979.38			
		66"(1676mm)	XLND-3066-JSNN	942.26	1017.73			
		72"(1829mm)	XLND-3072-JSNN	977.76	1056.08			
	36"(914mm)	36"(914mm)	XLND-3636-JSNN	\$ 807.36	\$ 872.00			
		42"(1067mm)	XLND-3642-JSNN	849.96	918.02			
		48"(1219mm)	XLND-3648-JSNN	892.56	964.04			
		54"(1372mm)	XLND-3654-JSNN	935.16	1010.06			
		60"(1524mm)	XLND-3660-JSNN	977.76	1056.08			
		66"(1676mm)	XLND-3666-JSNN	1020.36	1102.10			
		72"(1829mm)	XLND-3672-JSNN	1062.96	1148.12			
		78"(1981mm)	XLND-3678-JSNN	1105.56	1194.14			
<b>Wood</b>								
29.125"(740mm)	30"(762mm)	30"(762mm)	XZND-3030- SNS			\$1932.68	\$2129.54	\$2489.09
		36"(914mm)	XZND-3036- SNS			2058.08	2267.64	2627.19
		42"(1067mm)	XZND-3042- SNS			2183.48	2405.74	2765.29
		48"(1219mm)	XZND-3048- SNS			2308.88	2543.84	2903.39
		54"(1372mm)	XZND-3054- SNS			2434.28	2681.94	3041.49
		60"(1524mm)	XZND-3060- SNS			2559.68	2820.04	3179.59
		66"(1676mm)	XZND-3066- SNS			2685.08	2958.14	3317.69
		72"(1829mm)	XZND-3072- SNS			2810.48	3096.24	3455.79
	36"(914mm)	36"(914mm)	XZND-3636- SNS			\$2208.56	\$2433.36	\$3063.41
		42"(1067mm)	XZND-3642- SNS			2359.04	2599.08	3229.13
		48"(1219mm)	XZND-3648- SNS			2509.52	2764.80	3394.85
		54"(1372mm)	XZND-3654- SNS			2660.00	2930.52	3560.57
		60"(1524mm)	XZND-3660- SNS			2810.48	3096.24	3726.29
		66"(1676mm)	XZND-3666- SNS			2960.96	3261.96	3892.01
		72"(1829mm)	XZND-3672- SNS			3111.44	3427.68	4057.73
		78"(1981mm)	XZND-3678- SNS			3261.92	3593.40	4223.45

## Convergent D-Worktop with Column

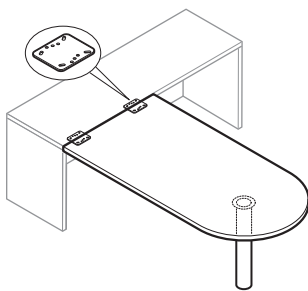
XLND-NS  
XZND-NS

## Features

- Includes worktop, column base, two flat brackets and column base attachment hardware.
- 1.1875"(30mm) thick laminate worktop with 3mm edgeband applied to user and visitor edges only.
- 1.1875"(30mm) thick wood worktop with a choice of profiled edge (Square, Bevel, Radius or Traditional) applied to user and visitor edges. Double-cut veneers available with Square 3mm Radius edge only.
- Attachment edge of worktop with Bevel, Radius and Traditional profiled edge is coped.
- 4"(102mm) diameter column leg with 3"(76mm) adjustment.
- Shipped unassembled.

## Specification Tips

- Not designed to stand alone.
- Two flat brackets to allow for attachment to modular credenza.
- Accommodates separately specified center drawer.
- Separately specified grommets can be field installed in desk worktop.

## To Order, Specify:

- 1) Product number, including:

## ① Edge Option:

Wood:

- 1** Square
- 5** Bevel
- 6** Radius
- 7** Traditional

- 2) Finish code for worktop (laminate or wood).
- 3) Laminate edge trim for worktop (if laminate option specified).
- 4) Column trim color (required).

**Note:** \$386.96 upcharge (list) for optional chrome column trim.

# Masters Series

## Convergent P-Worktop with Column

Height	Depth	Width	Number ① ②	Laminate		Wood Group A	Wood Group B	
				A	B	Edge Options 1	Edge Options 1	5,6,7
<b>Laminate</b>								
29.125"(740mm)	30"(762mm)	54"(1372mm)	XLNP-3054-JS █ N	\$1109.13	\$1197.83			
		60"(1524mm)	XLNP-3060-JS █ N	1170.73	1259.43			
		66"(1676mm)	XLNP-3066-JS █ N	1232.33	1321.03			
		72"(1829mm)	XLNP-3072-JS █ N	1293.93	1382.63			
	36"(914mm)	66"(1676mm)	XLNP-3666-JS █ N	\$1268.66	\$1357.36			
		72"(1829mm)	XLNP-3672-JS █ N	1330.26	1418.96			
		78"(1981mm)	XLNP-3678-JS █ N	1391.86	1480.56			
		<b>Wood</b>						
29.125"(740mm)	30"(762mm)	54"(1372mm)	XZNP-3054- █ S █ S			\$2983.75	\$3285.85	\$3663.80
		60"(1524mm)	XZNP-3060- █ S █ S			3099.80	3413.78	3791.73
		66"(1676mm)	XZNP-3066- █ S █ S			3215.85	3541.71	3919.66
		72"(1829mm)	XZNP-3072- █ S █ S			3331.90	3669.64	4047.59
	36"(914mm)	66"(1676mm)	XZNP-3666- █ S █ S			\$3252.18	\$3583.97	\$4059.28
		72"(1829mm)	XZNP-3672- █ S █ S			3368.23	3711.90	4187.21
		78"(1981mm)	XZNP-3678- █ S █ S			3484.28	3839.83	4315.14

### Convergent P-Worktop with Column

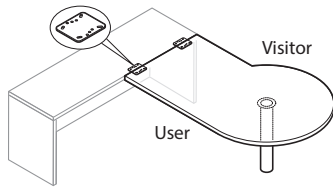

XLNP-RS  
XTNP-RS  
XZNP-RS  
(Right-hand shown)

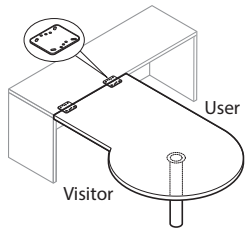

XLNP-LS  
XZNP-LS  
(Left-hand shown)

### Features

- Includes worktop, column base, two flat brackets and column base attachment hardware.
- 1.1875"(30mm) thick laminate worktop with 3mm edgeband applied to user and visitor edges only.
- 1.1875"(30mm) thick wood worktop with a choice of profiled edge (Square, Bevel, Radius or Traditional) applied to user and visitor edges. Double-cut veneers available with Square 3mm Radius edge only.
- Attachment edge of worktop is coped for Bevel, Radius and Traditional profiled edges.
- 4"(102mm) diameter column leg with 3"(76mm) adjustment.
- Shipped unassembled.

### Specification Tips

- Not designed to stand alone.
- Designed to be used with 2H desks/storage.
- See Stack-on Application Rules in Specification Guide.
- 30"(762mm) deep worktop has 42"(1067mm) diameter conference end, handed with radius extending away from user.
- 36"(914mm) deep worktop has 48"(1219mm) diameter conference end, handed with radius extending away from user.
- Designed to attach to credenzas built with modular components.
- Accommodates separately specified center drawer.
- 72"(1829mm) convergent worksurfaces and wrap-around convergent worksurfaces, panel hung, or freestanding, use WUAR-3900-PH.

### To Order, Specify:

- 1) Product number, including:

#### ① Edge Option:

Wood:

- 1 Square
- 5 Bevel
- 6 Radius
- 7 Traditional

#### ② Orientation:

- L Left-hand
- R Right-hand

- 2) Finish code for worktop (laminate or wood).
- 3) Laminate edge trim for worktop (if laminate option specified).
- 4) Column trim color (required).

**Note:** \$386.96 upcharge (list) for optional chrome column trim.

## Masters Series

## Full Wedge Square Convergent Worktop with Column

Depth	Length	Number ① ②	Laminate		Wood Group A	Wood Group B
			A	B	Edge Options	Edge Options
48"(1219mm)	60"(1524mm)	XLNY-4860-JSNSNC	\$2765.17	\$2980.93	1	1 5,6,7
<b>Wood</b>						
48"(1219mm)	60"(1524mm)	XZNY-4860-■ SNS ■ C	\$4148.81	\$4621.32	\$5319.80	

## Full Wedge Square Convergent Worktop with Column

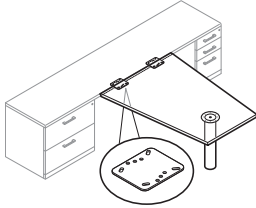
XLNY-YC  
XZNY-YC

## Features

- Includes worktop, column base, two flat brackets and column base attachment hardware.
- Wood worktop with choice of profiled edge (Square, Bevel, Radius or Traditional) applied to all edges except connection edge.
- Laminate worktop has a 3mm edgeband applied to all edges except connection edge.
- Double-cut veneers available with Square 3mm Radius edge only.
- Column leg allows for 3"(76mm) adjustment.
- Shipped unassembled.

## Specification Tips

- Accommodates separately specified center drawer.
- Not designed to stand alone.
- Designed to be used with 2H desks/storage.
- See Stack-on Application Rules in Specification Guide.
- Under-mount storage including accessory drawers are not for use in open kneespace; interferes with worktop attachment hardware.
- Cannot flush mount over storage.

## To Order, Specify:

- 1) Product number, including:

## ① Edge Option:

Wood:

- 1 Square
- 5 Bevel
- 6 Radius
- 7 Traditional

## ② Coped Edge Option:

- Y Yes
- N No (Square Edge Only)

- 2) Finish code for worktop (laminata or wood).
- 3) Laminate edge trim for worktop (if laminate option specified).
- 4) Column trim color (required).

**Note:** \$386.96 upcharge (list) for optional chrome column trim.

<b>Laminate</b>						
48"(1219mm)	60"(1524mm)	XLNY-4860-JSNSNB	\$3446.73	\$3662.49		
<b>Wood</b>						
48"(1219mm)	60"(1524mm)	XZNY-4860-■ SNSNB	\$4830.37	\$5302.88	\$6098.13	

## Full Wedge Square Convergent Worktop with Column and Stanchions

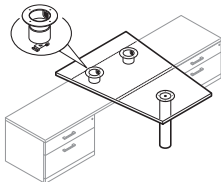
XLNY-NB  
XZNY-NB

## Features

- Includes worktop, column leg, two stanchion supports and column leg attachment hardware.
- Wood worktop with choice of profiled edge (Square, Bevel, Radius or Traditional) applied to all sides of worktop.
- Laminate worktop has a 3mm edgeband applied to all edges except connection edge.
- Double-cut veneers available with Square 3mm Radius edge only.
- Column leg allows for 3"(76mm) adjustment.
- Shipped unassembled.

## Specification Tips

- Designed to be used with 1.5H modular credenza. Not for use with 2H desks/storage.
- See Stack-on Application Rules in Specification Guide.
- Communication cables can be routed through stanchions.
- Stanchions are 4"(102mm) in diameter.
- Not designed to stand alone.

## To Order, Specify:

- 1) Product number, including:

## ① Edge Option:

Wood:

- 1 Square
- 5 Bevel
- 6 Radius
- 7 Traditional

- 2) Finish code for worktop (laminata or wood).
- 3) Laminate edge trim for worktop (if laminate option specified).
- 4) Column and stanchion trim color (required).

**Note:** \$498.80 upcharge (list) for optional chrome column and stanchion trim.

# Masters Series

## Full Wedge Square Slip Fit Convergent Worktop with Column

Depth	Width	Number ①	Laminate A	B	Wood Group A Edge Options 1	Wood Group B Edge Options 1	5,6,7
<b>Laminate</b>							
48"(1219mm)	60"(1524mm)	XLNY-4860-JSNSNS	\$2765.17	\$2980.93			
<b>Wood</b>							
48"(1219mm)	60"(1524mm)	XZNY-4860- SNSNS			\$4148.81	\$4621.32	\$5416.57

### Full Wedge Square Slip Fit Convergent Worktop with Column

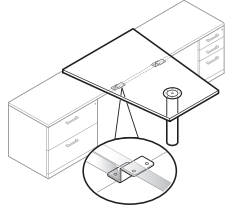

XLNY-NS  
XZNY-NS

#### Features

- Includes worktop, two Z attachment brackets, column leg and column leg attachment hardware.
- Wood worktop with choice of profiled edge (Square, Bevel, Radius or Traditional) applied to all sides of worktop.
- Laminate worktop has a 3mm edgeband applied to all edges except connection edge.
- Double-cut veneers available with Square 3mm Radius edge only.
- Column leg allows for 3"(76mm) adjustment.
- Shipped unassembled.

#### Specification Tip

- Not designed to stand alone.
- Designed to be used with 2H desks/storage.
- See Stack-on Application Rules in Specification Guide.
- Under-mount storage including accessory drawers are not for use in open kneespace; interferes with worktop attachment hardware.

#### To Order, Specify:

- 1) Product number, including:

#### ① Edge Option:

Wood:

- 1 Square
- 5 Bevel
- 6 Radius
- 7 Traditional

- 2) Finish code for worktop (laminated or wood).
- 3) Laminate edge trim for worktop (if laminate option specified).
- 4) Column trim color (required).

**Note:** \$386.96 upcharge (list) for optional chrome column trim.

# Masters Series

## Half Wedge Square Convergent Worktop with Column

Depth	Length	Number ① ② ③	Laminate		Wood Group A	Wood Group B
			A	B	Edge Options	Edge Options
					1	1 5,6,7
<b>Laminate</b>						
42"(1067mm)	60"(1524mm)	XLNZ-4260-JS ■ SNC	\$2512.77	\$2714.13		
45"(1143mm)	66"(1676mm)	XLNZ-4566-JS ■ SNC	2828.27	3047.63		
48"(1219mm)	72"(1829mm)	XLNZ-4872-JS ■ SNC	3169.01	3407.81		
<b>Wood</b>						
42"(1067mm)	60"(1524mm)	XZNZ-4260- ■ S ■ S ■ C			\$3844.81	\$4299.32 \$4948.09
45"(1143mm)	66"(1676mm)	XZNZ-4566- ■ S ■ S ■ C			4224.81	4701.82 5392.02
48"(1219mm)	72"(1829mm)	XZNZ-4872- ■ S ■ S ■ C			4635.21	5136.52 5868.14

### Half Wedge Square Convergent Worktop with Column

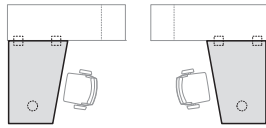
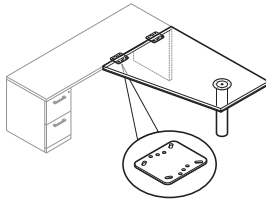

Left Hand  
Right Hand  
XLNZ-YC  
XZNZ-YC

### Features

- Includes worktop, column leg and column leg attachment hardware.
- Wood worktop with choice of profiled edge (Square, Bevel, Radius or Traditional) applied to all edges except connection edge.
- Laminate worktop has a 3mm edgeband applied to all edges except connection edge.
- Double-cut veneers available with Square 3mm Radius edge only.
- Column leg allows for 3"(76mm) adjustment.
- Shipped unassembled.

### Specification Tips

- Accommodates separately specified center drawer.
- Not designed to stand alone.
- Designed to be used with 2H desks/storage.
- See Stack-on Application Rules in Specification Guide.

### To Order, Specify:

1) Product number, including:

#### ① Edge Option:

Wood:

- 1 Square
- 5 Bevel
- 6 Radius
- 7 Traditional

#### ② Orientation:

- L Left-hand
- R Right-hand

#### ③ Coped Edge Option:

- Y Yes
- N No (Square Edge Only)

- 2) Finish code for worktop (laminate or wood).
- 3) Laminate edge trim for worktop (if laminate option specified).
- 4) Column trim color (required).

**Note:** \$386.96 upcharge (list) for optional chrome column trim.

# Masters Series

## Half Wedge Square Convergent Worktop with Column and Stanchions

Depth	Length	Number ① ②	Laminate		Wood Group A	Wood Group B		
			A	B	Edge Options	Edge Options	5,6,7	
<b>Laminate</b>								
42"(1067mm)	60"(1524mm)	XLNZ-4260-JS <input type="checkbox"/> SNB	<b>\$3194.33</b>	<b>\$3395.69</b>				
45"(1143mm)	66"(1676mm)	XLNZ-4566-JS <input type="checkbox"/> SNB	<b>3509.83</b>	<b>3729.19</b>				
48"(1219mm)	72"(1829mm)	XLNZ-4872-JS <input type="checkbox"/> SNB	<b>3850.57</b>	<b>4089.37</b>				
<b>Wood</b>								
42"(1067mm)	60"(1524mm)	XZNZ-4260- <input type="checkbox"/> S <input type="checkbox"/> SNB			<b>\$4526.37</b>	<b>\$4980.88</b>	<b>\$5745.64</b>	
45"(1143mm)	66"(1676mm)	XZNZ-4566- <input type="checkbox"/> S <input type="checkbox"/> SNB			<b>4906.37</b>	<b>5383.38</b>	<b>6197.85</b>	
48"(1219mm)	72"(1829mm)	XZNZ-4872- <input type="checkbox"/> S <input type="checkbox"/> SNB			<b>5316.77</b>	<b>5818.08</b>	<b>6682.26</b>	

### Half Wedge Square Convergent Worktop with Column and Stanchions

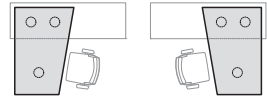
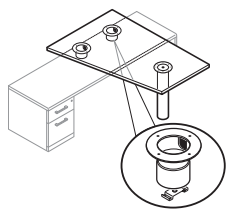

Left Hand

Right Hand

XLNZ-NB  
XZNZ-NB

#### Features

- Includes worktop, column leg, two stanchion supports and column leg attachment hardware.
- Wood worktop with choice of profiled edge (Square, Bevel, Radius or Traditional) applied to all sides of worktop.
- Laminate worktop has a 3mm edgeband applied to all edges except connection edge.
- Double-cut veneers available with Square 3mm Radius edge only.
- Shipped unassembled.

#### Specification Tips

- Communication cables can be routed through stanchions.
- Stanchions are 4"(102mm) in diameter.
- Not designed to stand alone.
- Designed to be used with 1.5H modular credenza. Not for use with 2H desks/storage.
- See Stack-on Application Rules in Specification Guide.

#### To Order, Specify:

- 1) Product number, including:

#### ① Edge Option:

Wood:

- 1 Square
- 5 Bevel
- 6 Radius
- 7 Traditional

#### ② Orientation:

- L Left-hand
- R Right-hand

- 2) Finish code for worktop (laminate or wood).
- 3) Laminate edge trim for worktop (if laminate option specified).
- 4) Column and stanchion trim color (required).

**Note:** \$498.80 upcharge (list) for optional chrome column and stanchion trim.

# Masters Series

## Half Wedge Square Convergent Worktop

Depth	Width	Number ① ②	Laminate		Wood Group A	Wood Group B
			A	B	Edge Options 1	Edge Options 1 5,6,7
<b>Laminate</b>						
42"(1067mm)	60"(1524mm)	XLNZ-4260-JS SNS	\$2512.77	\$2714.13		
45"(1143mm)	66"(1676mm)	XLNZ-4566-JS SNS	2828.27	3047.63		
48"(1219mm)	72"(1829mm)	XLNZ-4872-JS SNS	3169.01	3407.81		
<b>Wood</b>						
42"(1067mm)	60"(1524mm)	XZNZ-4260- S SNS			\$3844.81	\$4299.32 \$5064.08
45"(1143mm)	66"(1676mm)	XZNZ-4566- S SNS			4224.81	4701.82 5516.29
48"(1219mm)	72"(1829mm)	XZNZ-4872- S SNS			4635.21	5136.52 6000.70

### Half Wedge Square Slip Fit Convergent Worktop

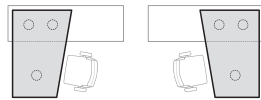
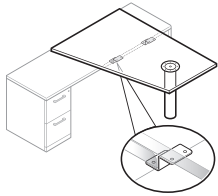

Left Hand  
XLNZ-NS  
XZNZ-NS

Right Hand

### Features

- Includes worktop, two Z attachment brackets, column leg and column leg attachment hardware.
- Wood worktop with choice of profiled edge (Square, Bevel, Radius or Traditional) applied to all sides of worktop.
- Laminate worktop has a 3mm edgeband applied to all edges except connection edge.
- Double-cut veneers available with Square 3mm Radius edge only.
- Shipped unassembled.

### Specification Tip

- Not designed to stand alone.
- Designed to be used with 1.5H modular credenza. Not for use with 2H desks/storage.
- See Stack-on Application Rules in Specification Guide.

### To Order, Specify:

- 1) Product number, including:

#### ① Edge Option:

Wood:

- 1 Square
- 5 Bevel
- 6 Radius
- 7 Traditional

#### ② Orientation:

- L Left-hand
- R Right-hand

- 2) Finish code for worktop (laminate or wood).
- 3) Laminate edge trim for worktop (if laminate option specified).
- 4) Column trim color (required).

**Note:** \$386.96 upcharge (list) for optional chrome column trim.

This page intentionally blank



## Masters Series

Bridge

## Bridge

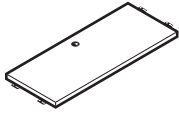
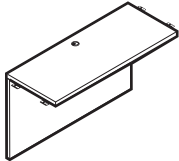
XLBF-NS  
XZBF-NSXLBF-FS  
XZBF-FS

## Features

- Includes worksurface, optional modesty panel and attachment hardware.
- 1.1875" (30mm) thick laminate worksurface with 3mm edgeband applied to user edge only; connection edges are unfinished.
- 1.1875" (30mm) thick wood worksurface with a choice of profiled edge (Square, Bevel, Radius or Traditional) applied to user edges. Double-cut veneers available with Square 3mm Radius edge only.
- Wood worksurfaces 36" (914mm), 42" (1067mm) and 48" (1219mm) wide available with choice of grain direction; side-to-side (standard) or front-to-back.
- Both attachment edges of wood veneer worksurfaces with Bevel, Radius and Traditional profiled edges are coped.
- Optional 2" (51mm) grommet centered in back of worksurface.
- Grommet available with option of black or satin finish.
- Shipped unassembled.

## Specification Tips

- Specified for use between single pedestal desks, desk shells and configured credenza units using modular components to create a "U-shaped" office configuration.
- Bridges with profiled edges not for use with corner units.
- See Corner Unit Application in Specification Guide.

## To Order, Specify:

1) Product number, including:

## ① Edge Option:

Wood:

- 1 Square
- 5 Bevel, add \$102.09 list
- 6 Radius, add \$102.09 list
- 7 Traditional, add \$102.09 list

## ② Grommet Option:

- Y Grommet, add \$178.68 list
- N No Grommet

## ③ Grain Direction (wood only):

(36", 42" and 48" wide only)

- F Front-to-back
- S Side-to-side

- 2) Finish code for modesty (if specified).
- 3) Laminate edge trim for modesty (if laminate option specified).
- 4) Finish code for bridge (laminate or wood).
- 5) Edge trim for bridge (if laminate option specified).
- 6) Trim color for grommet (if specified).

**Note:** Wood grained laminate worksurface finishes are applied with wood grain direction side-to-side only.

Height	Depth	Width	Number ①②③	Laminate	
				A	B
<b>Laminate — No Modesty</b>					
29.125"(740mm)	19"(483mm)	36"(914mm)	XLBF-1936-JS ■ NN	\$ 325.68	\$ 351.22
		42"(1067mm)	XLBF-1942-JS ■ NN	356.46	383.14
		48"(1219mm)	XLBF-1948-JS ■ NN	387.24	415.06
		54"(1372mm)	XLBF-1954-JS ■ NN	418.02	446.98
		60"(1524mm)	XLBF-1960-JS ■ NN	448.80	478.90
	24"(610mm)	36"(914mm)	XLBF-2436-JS ■ NN	\$ 374.28	\$ 401.62
		42"(1067mm)	XLBF-2442-JS ■ NN	413.16	441.94
		48"(1219mm)	XLBF-2448-JS ■ NN	452.04	482.26
		54"(1372mm)	XLBF-2454-JS ■ NN	490.92	522.58
		60"(1524mm)	XLBF-2460-JS ■ NN	529.80	562.90
<b>Laminate — Full Modesty</b>					
29.125"(740mm)	19"(483mm)	36"(914mm)	XLBF-1936-JS ■ FN	\$ 929.39	\$ 982.29
		42"(1067mm)	XLBF-1942-JS ■ FN	960.17	1014.21
		48"(1219mm)	XLBF-1948-JS ■ FN	990.95	1046.13
		54"(1372mm)	XLBF-1954-JS ■ FN	1021.73	1078.05
		60"(1524mm)	XLBF-1960-JS ■ FN	1052.51	1109.97
	24"(610mm)	36"(914mm)	XLBF-2436-JS ■ FN	\$ 977.99	\$1032.69
		42"(1067mm)	XLBF-2442-JS ■ FN	1016.87	1073.01
		48"(1219mm)	XLBF-2448-JS ■ FN	1055.75	1113.33
		54"(1372mm)	XLBF-2454-JS ■ FN	1094.63	1153.65
		60"(1524mm)	XLBF-2460-JS ■ FN	1133.51	1193.97

# Masters Series

## Bridge

Height	Depth	Width	Number <sup>1</sup> <sup>2</sup> <sup>3</sup>	Wood Group A	Group B
<b>Wood — No Modesty</b>					
29.125"(740mm)	19"(483mm)	36"(914mm)	XZBF-1936- S N	\$ 878.86	\$ 968.33
		42"(1067mm)	XZBF-1942- S N	956.38	1052.69
		48"(1219mm)	XZBF-1948- S N	1033.90	1137.05
		54"(1372mm)	XZBF-1954- S NS	1111.42	1221.41
		60"(1524mm)	XZBF-1960- S NS	1188.94	1305.77
	24"(610mm)	36"(914mm)	XZBF-2436- S N	\$1001.26	\$1101.53
		42"(1067mm)	XZBF-2442- S N	1099.18	1208.09
		48"(1219mm)	XZBF-2448- S N	1197.10	1314.65
		54"(1372mm)	XZBF-2454- S NS	1295.02	1421.21
		60"(1524mm)	XZBF-2460- S NS	1392.94	1527.77
<b>Wood — Full Modesty</b>					
29.125"(740mm)	19"(483mm)	36"(914mm)	XZBF-1936- S F	\$1557.20	\$1714.53
		42"(1067mm)	XZBF-1942- S F	1634.72	1798.89
		48"(1219mm)	XZBF-1948- S F	1712.24	1883.25
		54"(1372mm)	XZBF-1954- S FS	1789.76	1967.61
		60"(1524mm)	XZBF-1960- S FS	1867.28	2051.97
	24"(610mm)	36"(914mm)	XZBF-2436- S F	\$1679.60	\$1847.73
		42"(1067mm)	XZBF-2442- S F	1777.52	1954.29
		48"(1219mm)	XZBF-2448- S F	1875.44	2060.85
		54"(1372mm)	XZBF-2454- S FS	1973.36	2167.41
		60"(1524mm)	XZBF-2460- S FS	2071.28	2273.97

## Masters Series

Corner Shells

Height	Depth	Width	Number ① ② ③ ④	Laminate A	B	Wood Group A	Group B
<b>Laminate</b>							
29.125"(740mm)	36"(914mm)	36"(914mm)	XLCN-3636-JS ■ ■ ■	\$1892.29	\$2027.50		
	42"(1067mm)	42"(1067mm)	XLCN-4242-JS ■ ■ ■	1898.61	2033.82		
<b>Wood</b>							
29.125"(740mm)	36"(914mm)	36"(914mm)	XZCN-3636- ■ S ■ ■ ■			\$3003.64	\$3342.54
	42"(1067mm)	42"(1067mm)	XZCN-4242- ■ S ■ ■ ■			3199.81	3558.34

## Shell — Corner

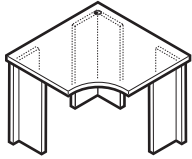
XLCN-22  
XZCN-22

## Features

- Includes worksurface, L-supports and attachment hardware.
- 1.1875"(30mm) thick laminate worksurface with 3mm edgeband applied to user edge only; connection edges are unfinished.
- 1.1875"(30mm) thick wood worksurface with a choice of profiled edge (Square, Bevel, Radius or Traditional) applied to user and visitor edges. Double-cut veneers available with Square 3mm Radius edge only.
- Available with No Modesty option only.
- 36" x 36"(914 x 914mm) corner available with an option of 19"(483mm) or 24"(610mm) deep attachment.
- 42" x 42"(1067 x 1067mm) corner available with an option of 24"(610mm) or 30"(762mm) deep attachment.
- 10" x 10"(254 x 254mm) L-support in back corner of corner shell.
- 19"(483mm) and 24"(610mm) deep connection edges include 10" x 10"(254 x 254mm) L-support.
- 30"(762mm) deep connection edges include 15" x 15" (381 x 381mm) L-support.
- L-supports include unfinished clearcoat integrated wireways.
- Optional 2"(51mm) grommet centered in back of worksurface.
- Grommet available with option of black or satin chrome finish.
- Glides provide 2"(51mm) adjustment range.
- Shipped unassembled.

## Specification Tips

- Attachment depth may differ each side of the corner shell.
- Designed to be used against wall.
- May be used with return tops or modular worksurface.
- Corner shell cannot be used with a pre-configured return or bridge with profiled edges; can be used with Square edge only.
- See Corner Unit Applications in Specification Guide.

## To Order, Specify:

1) Product number, including:

## ① Edge Option:

Wood:

- ① Square
- ⑤ Bevel, add \$245.60 list
- ⑥ Radius, add \$245.60 list
- ⑦ Traditional, add \$245.60 list

## ② Grommet Option:

- Y Grommet, add \$178.68 list
- N No Grommet

## ③ Attachment Depth Left:

- ① 19"(36" Corner Only)
- ② 24"
- ③ 30"(42" Corner Only)

## ④ Attachment Depth Right:

- ① 19"(36" Corner Only)
- ② 24"
- ③ 30"(42" Corner Only)

- 2) Finish code for lower supports (laminate or wood).
- 3) Laminate edge trim color for lower supports (if laminate option specified).
- 4) Laminate worksurface color (if laminate option specified).
- 5) Laminate edge trim for worksurface (if laminate option specified).
- 6) Trim color for grommet (if specified).

**Note:** Wood grained laminate worksurface finishes are applied with wood grain direction side-to-side only.

# Masters Series

## Return Tops – Rectangular

Height	Depth	Width	Number	① ② ③ ④ ⑤					Laminate		Wood	
				A	B	Group A	Group B	A	B			
<b>Laminate</b>												
29.125"(740mm)	19"(483mm)	36"(914mm)	XLBR-1936-JS	■	■	■	N	■	\$583.44	\$630.03		
		42"(1067mm)	XLBR-1942-JS	■	■	■	N	■	631.32	681.33		
		48"(1219mm)	XLBR-1948-JS	■	■	■	N	■	679.20	732.63		
		54"(1372mm)	XLBR-1954-JS	■	■	■	N	■	727.08	783.93		
		60"(1524mm)	XLBR-1960-JS	■	■	■	N	■	774.96	835.23		
	24"(610mm)	36"(914mm)	XLBR-2436-JS	■	■	■	N	■	\$659.04	\$711.03		
		42"(1067mm)	XLBR-2442-JS	■	■	■	N	■	719.52	775.83		
		48"(1219mm)	XLBR-2448-JS	■	■	■	N	■	780.00	840.63		
		54"(1372mm)	XLBR-2454-JS	■	■	■	N	■	840.48	905.43		
		60"(1524mm)	XLBR-2460-JS	■	■	■	N	■	900.96	970.23		
<b>Wood</b>												
29.125"(740mm)	19"(483mm)	36"(914mm)	XZBR-1936-	■	S	■	■	■			\$ 887.96	\$ 989.46
		42"(1067mm)	XZBR-1942-	■	S	■	■	■			975.74	1087.50
		48"(1219mm)	XZBR-1948-	■	S	■	■	■			1063.52	1185.54
		54"(1372mm)	XZBR-1954-	■	S	■	S	■			1151.30	1283.58
		60"(1524mm)	XZBR-1960-	■	S	■	S	■			1239.08	1381.62
	24"(610mm)	36"(914mm)	XZBR-2436-	■	S	■	■	■			\$1026.56	\$1144.26
		42"(1067mm)	XZBR-2442-	■	S	■	■	■			1137.44	1268.10
		48"(1219mm)	XZBR-2448-	■	S	■	■	■			1248.32	1391.94
		54"(1372mm)	XZBR-2454-	■	S	■	S	■			1359.20	1515.78
		60"(1524mm)	XZBR-2460-	■	S	■	S	■			1470.08	1639.62

### Return Top

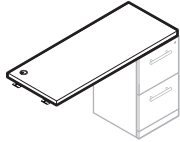

XLBR-SR  
XZBR-SR  
(Right shown)

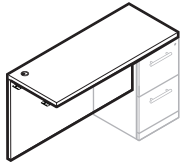

XLBR-SR  
XZBR-SR  
(Right shown)

### Features

- Includes worksurface, optional modesty panel and attachment hardware.
- 1.1875"(30mm) thick laminate worksurface with 3mm edgeband applied to user edge only; connection edge unfinished. End capped with 1mm thick edgeband.
- 1.1875"(30mm) thick wood worksurface with a choice of profiled edge (Square, Bevel, Radius or Traditional) applied to user edge only. Double-cut veneers available with Square 3mm Radius edge only.
- Optional 2"(51mm) grommet.
- Grommet available with option of black or satin finish.
- Includes one coped attachment edge for worksurfaces with Bevel, Radius and Traditional profiled edges.
- Wood worksurfaces 42"(1067mm) and 48"(1219mm) wide available with choice of grain direction; side-to-side or front-to-back.
- Optional modesty panel is .75"(19mm) thick; finished both sides.
- Shipped unassembled.

### Specification Tips

- Orientation option is based on storage placement not coped edge.
- Not for free-standing application.
- May be used between single pedestal desk or convergent and corner shell as a bridge.
- Connects to separately specified end panel or attached storage unit for use as a return.
- See Corner Unit Application in Specification Guide.

### To Order, Specify:

1) Product number, including:

#### ① Edge Option:

Wood:

- ① Square
- ⑤ Bevel, add \$115.82 list
- ⑥ Radius, add \$115.82 list
- ⑦ Traditional, add \$115.82 list

#### ② Grommet Option:

- ① Y Grommet, add \$178.68 list
- ① N No Grommet

#### ③ Modesty Option:

- ① F Full Height, add \$638.17 list
- ① N No Modesty

#### ④ Grain Direction (wood only):

(36", 42" and 48" wide only)

- ① F Front-to-back
- ① S Side-to-side

#### ⑤ Orientation:

- ① L Left
- ① R Right

2) Finish code for modesty (if specified).

3) Laminate edge trim color for modesty (if specified).

4) Finish code for return top (laminate or wood).

5) Edge trim for return top (if laminate option specified).

6) Trim color for grommet (if specified).

**Note:** Wood grained laminate worksurface finishes are applied with wood grain direction side-to-side only.

## Masters Series

Returns with Pedestal

Height	Depth	Width	Number	1	2	3	4	5	6	Wood Group A	Group B
<b>Wood</b>											
29.125"(740mm)	19"(483mm)	42"(1067mm)	XZRP-1942-	SS						\$2763.01	\$3080.90
		48"(1219mm)	XZRP-1948-	SS						2873.21	3202.12
		54"(1372mm)	XZRP-1954-	SS					S	2983.41	3323.34
		60"(1524mm)	XZRP-1960-	SS					S	3093.61	3444.56

## Return with Pedestal

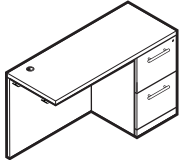

XLRP-RS  
XZRP-RS  
(Right-hand shown)

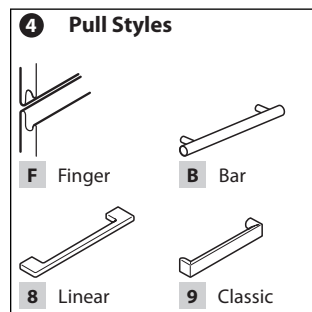

## Features

- Includes worksurface, case and one pedestal.
- 1.1875"(30mm) thick wood worksurface with a choice of profiled edge (Square, Bevel, Radius or Traditional) applied to user edge only; connection edge unfinished. End capped with 1mm thick edgeband. Double-cut veneers available with Square edge only.
- Includes coped attachment edge for worksurfaces with Bevel, Radius and Traditional profiled edges.
- Wood worksurfaces 42"(1067mm) and 48"(1219mm) wide available with choice of grain direction; side-to-side (**\$87.47**) or front-to-back.
- Optional 2"(51mm) grommet oriented to connection end of return top.
- Grommet and lock plug available with option of black or chrome finish; chrome grommet has a satin finish.
- Includes flush full overlay modesty panel; modesty veneered both sides.
- Letter width 15.5"(394mm) File/File pedestal.
- File drawers with an integrated file hanging system.
- Drawer pull options:
  - Bar pulls available in powdercoat finishes.
  - Linear and Classic pulls are available in satin nickel finish only.
  - Finger pull option available with Wood Group B finishes.
- File drawers have full extension slides.
- One lock standard per pedestal.
- For lock options, refer to Lock Program section of the Accessories Price List.
- Glides provide 2"(51mm) adjustment range.
- Return shell shipped unassembled, pedestal shipped assembled ready for field installation.

## Specification Tips

- Not designed for free-standing application.
- Handed design (left or right) based on position of pedestal.
- Connects to single pedestal desk or desk shell.
- Return with Square edge only available for use with corner shell; not for use with profiled edges.
- Can be utilized with attached 2H lower storage; no back option must be specified.

## To Order, Specify:

1) Product number, including:

**1 Edge Option:**

Wood:

- 1** Square
- 5** Bevel, add **\$115.82** list
- 6** Radius, add **\$115.82** list
- 7** Traditional, add **\$115.82** list

**2 Pedestal Drawer Option:**

- 6** File/File Black Miterfold
- T** File/File Wood, add **\$143.83** list

**3 Drawer Pull Option:**

- F** Finger (Wood only)
- B** Bar
- 8** Linear
- 9** Classic

**4 Grommet Option:**

- Y** Grommet, add **\$178.68** list
- N** No Grommet

**5 Orientation:**

- L** Left
- R** Right

**6 Grain Direction:**

(42" and 48" wide only)

- F** Front-to-back
- S** Side-to-side

2) Finish code (wood only).

3) Trim color for bar pull (if specified).

4) Trim color for lock (required) and grommet (if specified).

# Masters Series

Returns with Lateral File

Height	Depth	Width	Number	1	2	3	4	5	Wood Group A	Group B
29.125"(740mm)	19"(483mm)	60"(1524mm)	XZRL-1960-	SS				S	\$3825.59	\$4259.87

## Return with 30" Wide Lateral File

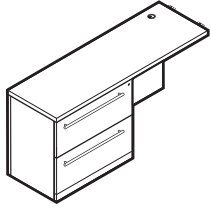

XLRL-LS  
XZRL-LS  
(Left-hand shown)

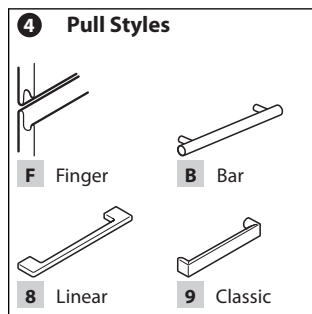

### Features

- Includes worksurface, case and 30"(762mm) wide lateral file.
- 1.1875"(30mm) thick wood worksurface with a choice of profiled edge (Square, Bevel, Radius or Traditional) applied to user edge only; connection edge unfinished. End capped with 1mm thick edgeband. Double-cut veneers available with Square edge only.
- Includes coped attachment edge for worksurfaces with Bevel, Radius and Traditional profiled edges.
- Optional 2"(51mm) grommet oriented to connection end of return top.
- Grommet and lock plug available with option of black or chrome finish; chrome grommet has a satin finish.
- Includes flush full overlay modesty panel; modesty finished on both sides.
- File drawers with an integrated file hanging system.
- Drawer pull options:
  - Bar pulls available in powdercoat finishes.
  - Linear and Classic pulls are available in satin nickel finish only.
  - Finger pull option available with Wood Group B finishes.
- File drawers have full extension slides.
- One lock standard per lateral file.
- For lock options, refer to Lock Program section of the Accessories Price List.
- Glides provide 2"(51mm) adjustment range.
- Return shell shipped unassembled, lateral file shipped assembled ready for field installation.

### Specification Tips

- Not designed for free-standing application.
- Handed design (left or right) based on position of lateral file.
- Connects to single pedestal desk or desk shell.
- Return with Square edge only available for use with corner shell; not for use with profiled edges.
- Can be utilized with attached 2H lower storage; no back option must be specified.

### To Order, Specify:

1) Product number, including:

#### 1 Edge Option:

Wood:

- 1** Square
- 5** Bevel, add \$118.15 list
- 6** Radius, add \$118.15 list
- 7** Traditional, add \$118.15 list

#### 2 File Drawer Option:

- J** Black Miterfold
- Y** Wood, add \$177.19 list

#### 3 Drawer Pull Option:

- F** Finger (Wood only)
- B** Bar
- 8** Linear
- 9** Classic

#### 4 Grommet Option:

- Y** Grommet, add \$178.68 list
- N** No Grommet

#### 5 Orientation:

- L** Left
- R** Right

2) Finish code (wood only).

3) Trim color for bar pull (if specified).

4) Trim color for lock (required) and grommet (if specified).

# Masters Series

Credenzas with Pedestals

	Height	Depth	Width	Number	1	2	3	4	Wood Group A	Group B
<b>Credenza with Pedestals</b>	29.125"(740mm)	24"(610mm)	72"(1829mm)	XZZP-2472-	SS				\$5167.04	\$5784.00

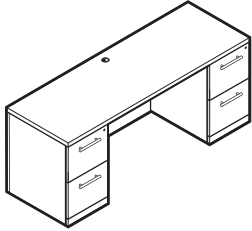

XZZP-BY

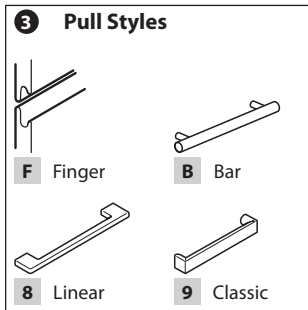

**Features**

- Includes worksurface, case and two pedestals.
- 1.1875"(30mm) thick wood worksurface with a choice of profiled edge (Square, Bevel, Radius or Traditional) applied to user edge only. Double-cut veneers available with Square edge only.
- Optional 2"(51mm) grommet centered in back of worksurface.
- Grommet and lock plugs available with option of black or chrome finish; chrome grommet has a satin finish.
- Includes flush full overlay modesty panel; modesty finished on both sides.
- Two letter width 15.5"(394mm) File/File pedestals.
- File drawers with an integrated file hanging system.
- Drawer pull options:
  - Bar pulls available in powdercoat finishes.
  - Linear and Classic pulls are available in satin nickel finish only.
  - Finger pull option available with Wood Group B finishes.
- File drawers have full extension slides.
- One lock standard per pedestal; each pedestal locks separately.
- Common keys within each credenza.
- For lock options, refer to Lock Program section of the Accessories Price List.
- Glides provide 2"(51mm) adjustment range.
- Credenza shipped unassembled, storage shipped assembled ready for field installation.

**Specification Tips**

- May be used with vertical storage unit of equal width.

**To Order, Specify:**

1) Product number, including:

**1 Edge Option:**

- 1** Square
- 5** Bevel, add \$118.15 list
- 6** Radius, add \$118.15 list
- 7** Traditional, add \$118.15 list

**2 Pedestal Drawer Option:**

- 66** Two File/File Black Miterfold
- TT** Two File/File Wood, add \$295.32 list

**3 Drawer Pull Option:**

- F** Finger
- B** Bar
- 8** Linear
- 9** Classic

**4 Grommet Option:**

- Y** Grommet, add \$178.68 list
- N** No Grommet

2) Finish code (wood only).

3) Trim color for bar pull (if specified).

4) Trim color for lock plug (required) and grommet (if specified).

This page intentionally blank



## Masters Series

## Height Adjustable Credenza Desk — Rectangular – T-Leg Base

### Height Adjustable Credenza Desk Features

#### — Rectangular – T-Leg Base

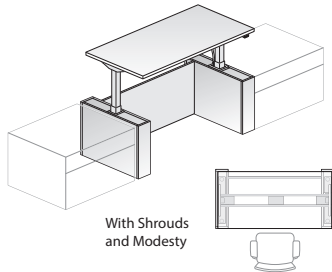
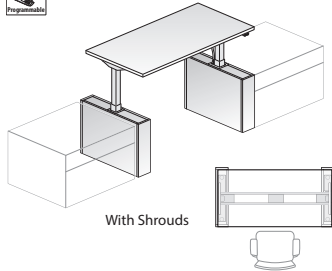
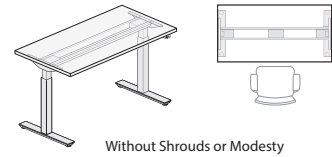

XLZR-2460  
XZZR-2460

- Includes 1.1875" (36mm) thick top, T-leg base assembly, wire management clips, height adjustment mechanism and hardware.
- Pair of Shrouds with two bezels, cable chain and attachment hardware
- Pair of Shrouds and Modesty with two bezels, cable chain, modesty and attachment hardware.
- Actual top width and depth is 2" (51mm) less than nominal width and depth.
- Height adjustment touch pad actuator options:
  - Single Stage Touch Pad Actuator available in Standard (E) up/down movement or Programmable (R) providing four different up/down programmed heights. Provides 27" (686mm) to 46" (1168mm) continuous height adjustment range.
- Touch Pad Actuator:
  - Can be mounted on left or right side of table; predrilled for field installed and field changeable.
  - Touch pad actuator has touch pad controls and standard with black housing.
  - Control box is field installed and standard with black housing.
- Height adjustment: 1" (25mm) per 1.6 seconds.
  - Telescoping base tubes and J-rails. Telescoping base tubes will match base trim color. Smooth paint trim will match. Textured paint will be complimentary.
- Includes: 9.5' (2895.6mm) long black power cord with NEMA 5-15P plug to the building.
- Base includes leg assembly and foot; available in painted trim colors.
- Glides have .5" (13mm) height adjustment and are standard in black.
- Grommets are available for field installation; separately specified. Specification Guide.

#### Specification Tips

- Top is designed to allow pinch point clearance to accommodate cables. The undersized top provides:
  - 1" (25mm) gap along each side of the top between the adjacent furnishings or building architecture.
  - 2" (51mm) gap along the back of the top between the building architecture to accommodate cables and a tackboard above the top.
- Pinch point should be adjusted when using spacers and a tackboard.
- Separately specified Reinforcement Channel or Bar are not required.
- A pair of shrouds are optional; a shroud is an aesthetic cover which conceals a Height Adjustable T-Leg.
- For a Height Adjustable Credenza Desk with Shrouds:
  - See options below; select the catalog number for a pair of shrouds.
  - A modesty panel for use with shrouds may be specified as a functional option; modesty not for use with exposed T-Legs.
  - Shroud base material to match worksurface material.
- Height Adjustable Credenza Desk without shrouds may be used with a separately specified Adaptable Modesty Panel.
- Height Adjustable Credenza Desk is not for use with separately specified Shroud for use with Adjustable T-Legs; dimensionally different shrouds.

#### Electrical:

- For use with separately specified electrical components: (Note: All of the options shown below require field cut mounting holes in the top. Ensure placement provides adequate clearance for table understructure.)
  - Flush Mounted Power Module Cord for Height Adjustable or Hardwire
  - Enhanced Power Module Corded or Hardwire with mounting bracket
  - Flip Top Unit Corded or Hardwire
  - Workware connect narrow non-switching interface module
  - Bezel Utility Module
- Height Adjustable Credenza Desk is not for use with AKP's, suspended or attached pedestals.
- Total lifting capacity of table is 250 lbs. including surface; applied weight should be evenly distributed.

#### To Order, Specify:

- Product number, including:

#### 1 Surface Option:

- L** Laminate
- Z** Wood

#### 2 Edge Option:

- J** Edgeband (Laminate only)
- 1** Square (Wood only)
- 5** Bevel (Wood only)
- 6** Radius (Wood only)
- 7** Traditional (Wood only)

#### 3 Height Adjustment Actuator Option:

Single Stage:

- E** Standard
- R** Programmable, add **\$187.41** list

#### 4 Lower Material:

**(Lower Material always matches top Material)**

(Shrouds only or Shrouds and Modesty Panel)

- L** Laminate
- W** Wood (lower material shroud and modesty)

#### No Shroud or Modesty:

- Laminate surface color or wood finish color for top material.
- Edge trim color (laminate only).
- Trim color for base

#### With Shroud:

- Laminate surface color or wood finish color for Shroud.
- Edge trim color (laminate only).
- Laminate surface color or wood finish for top material.
- Edge trim color (laminate only).
- Trim color for base (including bezel).

#### With Shroud and Modesty:

- Laminate surface color or wood finish color for Shroud and Modesty.
- Edge trim color (laminate only).
- Laminate surface color or wood finish for top material.
- Edge trim color (laminate only).
- Trim color for base (including bezel).

**Note:** **\$56.58** upcharge (list) for Metallic and accent trim colors.

Table Depth and Base	Screens	Monitor Arms
29" (737mm) T-Leg Glides	Yes	Yes (50 lbs max)
35" (889mm) T-Leg Glides	Yes	Yes (50 lbs max)
41" (1041mm) T-Leg Glides	Yes	Yes (50 lbs max)

# Masters Series

Height Adjustable Credenza Desk — Rectangular – T-Leg Base

Depth	Width	Number			Laminate		Wood Group A	Wood Group B	Wood Group B		
		①	②	③ ④	A	B	Edge Options 1	Edge Options 1	Edge Options 5,6,7		
<b>Without Shrouds or Modesty</b>											
24"(610mm)	60"(1524mm)	X	ZR-2460-	SNNB		N	\$2398.63	\$2541.84	\$3747.63	\$3822.79	\$3962.66
	66"(1676mm)	X	ZR-2466-	SNNB		N	2437.11	2580.32	3805.43	3881.67	4021.54
	72"(1829mm)	X	ZR-2472-	SNNB		N	2475.59	2618.80	3863.23	3940.55	4080.42
30"(762mm)	60"(1524mm)	X	ZR-3060-	SNNB		N	\$2494.83	\$2638.04	\$3892.13	\$3969.99	\$4109.86
	66"(1676mm)	X	ZR-3066-	SNNB		N	2542.93	2686.14	3964.38	4043.59	4183.46
	72"(1829mm)	X	ZR-3072-	SNNB		N	2591.03	2734.24	4036.63	4117.19	4257.06
<b>With Shrouds and no Modesty</b>											
24"(610mm)	60"(1524mm)	X	ZR-2460-	SNSB		N	\$4850.66	\$5190.00	\$7993.44	\$8323.35	\$8463.22
	66"(1676mm)	X	ZR-2466-	SNSB		N	4889.14	5228.48	8051.24	8382.23	8522.10
	72"(1829mm)	X	ZR-2472-	SNSB		N	4927.62	5266.96	8109.04	8441.11	8580.98
30"(762mm)	60"(1524mm)	X	ZR-3060-	SNSB		N	\$4946.86	\$5286.20	\$8137.94	\$8470.55	\$8610.42
	66"(1676mm)	X	ZR-3066-	SNSB		N	4994.96	5334.30	8210.19	8544.15	8684.02
	72"(1829mm)	X	ZR-3072-	SNSB		N	5043.06	5382.40	8282.44	8617.75	8757.62
<b>With Shrouds and Modesty</b>											
24"(610mm)	60"(1524mm)	X	ZR-2460-	SNSB		M	\$5214.30	\$5556.14	\$8831.94	\$9192.23	\$9332.10
	66"(1676mm)	X	ZR-2466-	SNSB		M	5252.78	5594.62	8889.74	9251.11	9390.98
	72"(1829mm)	X	ZR-2472-	SNSB		M	5291.26	5633.10	8947.54	9309.99	9449.86
30"(762mm)	60"(1524mm)	X	ZR-3060-	SNSB		M	\$5310.50	\$5652.34	\$8976.44	\$9339.43	\$9479.30
	66"(1676mm)	X	ZR-3066-	SNSB		M	5358.60	5700.44	9048.69	9413.03	9552.90
	72"(1829mm)	X	ZR-3072-	SNSB		M	5406.70	5748.54	9120.94	9486.63	9626.50

## Masters Series

## Credenzas with Pedestals and Closed Storage

	Height	Depth	Width	Number	1	2	3	4	5	Wood Group A	Group B
<b>Credenza with Pedestals and Closed Storage</b>	29.125"(740mm)	24"(610mm)	72"(1829mm)	XZZS-2472-	SS	■	■	■	■	\$8053.74	\$9015.35

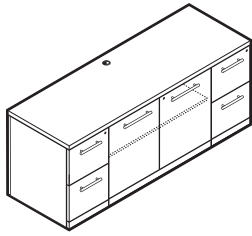

XZZS-YL

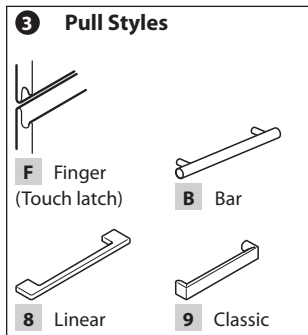
**Features**

- Includes worksurface, storage cabinet and two pedestals.
- 1.1875"(30mm) thick wood worksurface with a choice of profiled edge (Square, Bevel, Radius or Traditional) applied to user edge only. Double-cut veneers available with Square edge only.
- Optional 2"(51mm) grommet centered in back of worksurface.
- Grommet and lock plugs available with option of black or chrome finish; chrome grommet has a satin finish.
- Finished veneer back.
- Two letter width 15.5"(394mm) File/File pedestals.
- File drawers with an integrated file hanging system.
- Drawer pull options:
  - Bar pulls available in powdercoat finishes.
  - Linear and Classic pulls are available in satin nickel finish only.
  - Finger pull option available with Wood Group B finishes.
- File drawers have full extension slides.
- Storage cabinet utilize concealed hinges.
- One interior .75"(19mm) thick wood shelf in storage cabinet with  $\pm 1.25"$ (32mm) adjustment range.
- One lock standard per pedestal; each pedestal locks separately.
- Common keys within each credenza.
- Optional lock available on storage cabinet.
- For lock options, refer to Lock Program section of the Accessories Price List.
- Glides provide 2"(51mm) adjustment range.
- Credenza shipped fully assembled and ready for field installation.

**Specification Tip**

- May be used with vertical storage unit of equal width.

**To Order, Specify:**

1) Product number, including:

**1 Edge Option:**

- 1** Square
- 5** Bevel, add \$118.15 list
- 6** Radius, add \$118.15 list
- 7** Traditional, add \$118.15 list

**2 Pedestal Drawer Option:**

- 66** Two File/File Black Miterfold
- TT** Two File/File Wood, add \$293.41 list

**3 Drawer/Door Pull Option:**

- F** Finger (Touch latch)
- B** Bar
- 8** Linear
- 9** Classic

**4 Grommet Option:**

- Y** Grommet, add \$178.68 list
- N** No Grommet

**5 Lock Option for Storage:**

- N** No Lock
- L** Lock, add \$169.05 list

2) Finish code (wood only).

3) Trim color for bar pull (if specified).

4) Trim color for lock plugs (if specified) and grommet (if specified).

# Masters Series

## Credenzas with Lateral Files

	Height	Depth	Width	Number	①	②	③	Wood Group A	Group B
<b>Credenza with 36" Wide Lateral Files</b>	29.125"(740mm)	24"(610mm)	72"(1829mm)	XZZL-2472-	SS		N	\$6869.71	\$7352.21

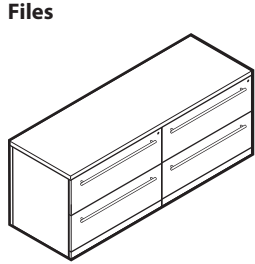

XZZL-BN

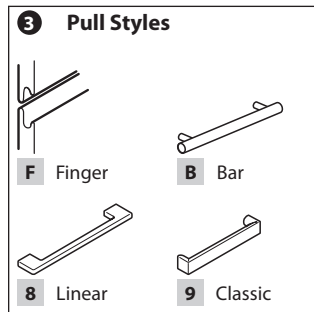

### Features

- Includes worksurface and two 36"(914mm) wide lateral files.
- 1.1875"(30mm) thick wood worksurface with a choice of profiled edge (Square, Bevel, Radius or Traditional) applied to user edge only. Double-cut veneers available with Square 3mm Radius edge only.
- Finished wood back.
- File drawers with an integrated file hanging system.
- Drawer pull options:
  - Bar pulls available in powdercoat finishes.
  - Linear and Classic pulls are available in satin nickel finish only.
  - Finger pull option available with Wood Group B finishes.
- File drawers have full extension slides.
- One lock with dual lock bar system standard per lateral file; each lateral file locks separately.
- Common keys within each credenza.
- Lock plug is available in black or satin chrome.
- For lock options, refer to Lock Program section of the Accessories Price List.
- Glides provide 2"(51mm) adjustment range.
- Credenza shipped fully assembled and ready for field installation.

### Specification Tips

- May be used with vertical storage unit of equal width.

### To Order, Specify:

- 1) Product number, including:

#### ① Edge Option:

- 1 Square
- 5 Bevel, add \$115.82 list
- 6 Radius, add \$115.82 list
- 7 Traditional, add \$115.82 list

#### ② Drawer Option:

- KK Black Miterfold
- ZZ Wood, add \$345.56 list

#### ③ Drawer Pull Option:

- F Finger
- B Bar
- 8 Linear
- 9 Classic

- 2) Finish code (wood only).
- 3) Trim color for bar pull (if specified).
- 4) Trim color for lock plug (required).

# Masters Series

## Credenzas with Lateral Files

	Height	Depth	Width	Number	①	②	③	④	Wood Group A	Group B
<b>Credenza with 30" Wide Lateral Files and Kneespace</b>	29.125"(740mm)	24"(610mm)	90"(2286mm)	XZZM-2490-	SS	■	■	■	\$6670.24	\$7148.11

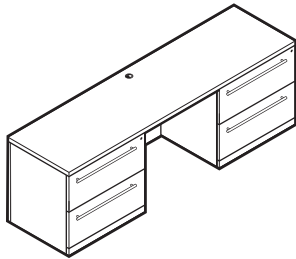

XZZM-BY

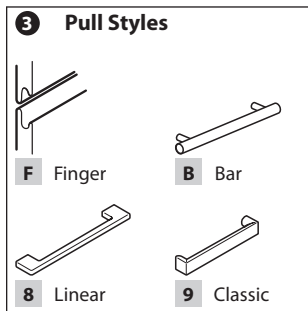

### Features

- Includes worksurface, case and two 30"(762mm) wide lateral files.
- 1.1875"(30mm) thick wood worksurface with a choice of profiled edge (Square, Bevel, Radius or Traditional) applied to user edge only. Double-cut veneers available with Square 3mm Radius edge only.
- Optional 2"(51mm) grommet centered in back of worksurface.
- Grommet and lock plugs available with option of black or chrome finish; chrome grommet has a satin finish.
- Includes flush full overlay modesty panel; wood finish both sides.
- File drawers with an integrated file hanging system.
- Drawer pull options:
  - Bar pulls available in powdercoat finishes.
  - Linear and Classic pulls are available in satin nickel finish only.
  - Finger pull option available with Wood Group B finishes.
- File drawers have full extension slides.
- One lock with dual lock bar system standard per lateral file; each lateral file locks separately.
- Common keys within each credenza.
- For lock options, refer to Lock Program section of the Accessories Price List.
- Glides provide 2"(51mm) adjustment range.
- Credenza shipped fully assembled and ready for field installation.

### Specification Tips

- May be used with vertical storage unit of equal width.

### To Order, Specify:

- 1) Product number, including:

#### ① Edge Option:

- 1** Square
- 5** Bevel, add \$118.15 list
- 6** Radius, add \$118.15 list
- 7** Traditional, add \$118.15 list

#### ② Pedestal Drawer Option:

- JJ** 30" wide Black Miterfold
- YY** 30" wide Wood, add \$352.42 list

#### ③ Drawer Pull Option:

- F** Finger
- B** Bar
- 8** Linear
- 9** Classic

#### ④ Grommet Option:

- Y** Grommet, add \$178.68 list
- N** No Grommet

- 2) Finish code (wood only).
- 3) Trim color for bar pull (if specified).
- 4) Trim color for lock plugs (required) and grommet (if specified).

# Masters Series

## Vertical Storage Units Open

### Vertical Storage Unit — 1H Open Features

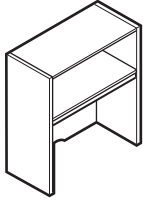

30" and 36" widths

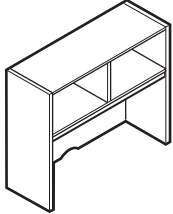

42", 48" and 54" widths

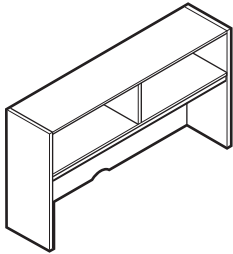

60", 66" and 72" widths

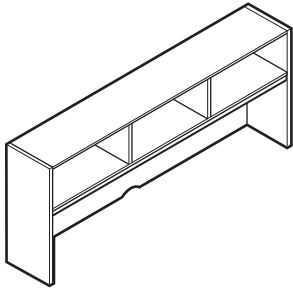

78", 84", 90" and 96" widths

X4UL-NN  
X4UD-NN  
X5UL-NN  
X5UD-NN

- Includes 2"(51mm) integrated light valance, vertical supports and attachment material.
- 23.375"(594mm) clearance between top of worksurface and bottom of light valance.
- Standard unfinished two-piece back.
- The underside of the cabinet and front of lower section:
  - Laminate - the underside of the cabinet and front of lower section is finished.
  - Wood - the underside of the cabinet is finished, the lower section is finished with backer sealer (black).
- Unfinished clearcoat wireway scallop in bottom center of back panel.
- Shipped assembled.

### Specification Tips

- Not for use on a freestanding or standalone desk.
- Designed to stack on equal width credenza, 2H storage cabinet or 2H lateral file. Refer to Stack-on Application Rules in Specification Guide.
- Accommodates separately specified tackboards and lighting accessories. Tackboard will block the ability to drop cords down or bring power to the surface. Use field installed grommets for power access.
- Aligns with 5H storage units.
- Wood units are not designed for applications where the back of unit is visible.

### To Order, Specify:

- 1) Product number.
- 2) Finish code (laminated or wood).
- 3) Laminate edge trim color (if laminate specified).

# Masters Series

Vertical Storage Units Open

Height	Width	Depth	Number	Laminate	
				A	B
<b>Laminate — Letter Depth</b>					
39.875"(1013mm)	30"(762mm)	14"(356mm)	X5UL-4030-NSNN	\$1519.17	\$1578.74
	36"(914mm)	14"(356mm)	X5UL-4036-NSNN	1630.87	1699.37
	42"(1067mm)	14"(356mm)	X5UL-4042-NSNN	1758.96	1836.39
	48"(1219mm)	14"(356mm)	X5UL-4048-NSNN	1870.66	1957.02
	54"(1372mm)	14"(356mm)	X5UL-4054-NSNN	1982.36	2077.65
	60"(1524mm)	14"(356mm)	X5UL-4060-NSNN	2094.06	2198.28
	66"(1676mm)	14"(356mm)	X5UL-4066-NSNN	2205.76	2318.91
	72"(1829mm)	14"(356mm)	X5UL-4072-NSNN	2317.46	2439.54
	78"(1981mm)	14"(356mm)	X5UL-4078-NSNN	2445.55	2576.56
	84"(2134mm)	14"(356mm)	X5UL-4084-NSNN	2557.25	2697.19
	90"(2286mm)	14"(356mm)	X5UL-4090-NSNN	2668.95	2817.82
	96"(2438mm)	14"(356mm)	X5UL-4096-NSNN	2780.65	2938.45

<b>Laminate — Legal Depth</b>					
39.875"(1013mm)	30"(762mm)	16.5"(419mm)	X5UD-4030-NSNN	\$1668.10	\$1739.58
	36"(914mm)	16.5"(419mm)	X5UD-4036-NSNN	1779.80	1860.21
	42"(1067mm)	16.5"(419mm)	X5UD-4042-NSNN	1907.89	1997.23
	48"(1219mm)	16.5"(419mm)	X5UD-4048-NSNN	2019.59	2117.86
	54"(1372mm)	16.5"(419mm)	X5UD-4054-NSNN	2131.29	2238.49
	60"(1524mm)	16.5"(419mm)	X5UD-4060-NSNN	2242.99	2359.12
	66"(1676mm)	16.5"(419mm)	X5UD-4066-NSNN	2354.69	2479.75
	72"(1829mm)	16.5"(419mm)	X5UD-4072-NSNN	2466.39	2600.38
	78"(1981mm)	16.5"(419mm)	X5UD-4078-NSNN	2594.48	2737.40
	84"(2134mm)	16.5"(419mm)	X5UD-4084-NSNN	2706.18	2858.03
	90"(2286mm)	16.5"(419mm)	X5UD-4090-NSNN	2817.88	2978.66
	96"(2438mm)	16.5"(419mm)	X5UD-4096-NSNN	2929.58	3099.29

Height	Width	Depth	Number	Wood	
				Group A	Group B
<b>Wood — Letter Depth</b>					
39.875"(1013mm)	30"(762mm)	14"(356mm)	X4UL-4030-NSNN	\$2114.94	\$2246.01
	36"(914mm)	14"(356mm)	X4UL-4036-NSNN	2286.23	2431.14
	42"(1067mm)	14"(356mm)	X4UL-4042-NSNN	2473.91	2632.66
	48"(1219mm)	14"(356mm)	X4UL-4048-NSNN	2645.20	2817.79
	54"(1372mm)	14"(356mm)	X4UL-4054-NSNN	2816.49	3002.92
	60"(1524mm)	14"(356mm)	X4UL-4060-NSNN	2987.78	3188.05
	66"(1676mm)	14"(356mm)	X4UL-4066-NSNN	3159.07	3373.18
	72"(1829mm)	14"(356mm)	X4UL-4072-NSNN	3330.36	3558.31
	78"(1981mm)	14"(356mm)	X4UL-4078-NSNN	3518.04	3759.83
	84"(2134mm)	14"(356mm)	X4UL-4084-NSNN	3689.33	3944.96
	90"(2286mm)	14"(356mm)	X4UL-4090-NSNN	3860.62	4130.09
	96"(2438mm)	14"(356mm)	X4UL-4096-NSNN	4031.91	4315.22

<b>Wood — Legal Depth</b>					
39.875"(1013mm)	30"(762mm)	16.5"(419mm)	X4UD-4030-NSNN	\$2316.02	\$2467.16
	36"(914mm)	16.5"(419mm)	X4UD-4036-NSNN	2487.31	2652.29
	42"(1067mm)	16.5"(419mm)	X4UD-4042-NSNN	2674.99	2853.81
	48"(1219mm)	16.5"(419mm)	X4UD-4048-NSNN	2846.28	3038.94
	54"(1372mm)	16.5"(419mm)	X4UD-4054-NSNN	3017.57	3224.07
	60"(1524mm)	16.5"(419mm)	X4UD-4060-NSNN	3188.86	3409.20
	66"(1676mm)	16.5"(419mm)	X4UD-4066-NSNN	3360.15	3594.33
	72"(1829mm)	16.5"(419mm)	X4UD-4072-NSNN	3531.44	3779.46
	78"(1981mm)	16.5"(419mm)	X4UD-4078-NSNN	3719.12	3980.98
	84"(2134mm)	16.5"(419mm)	X4UD-4084-NSNN	3890.41	4166.11
	90"(2286mm)	16.5"(419mm)	X4UD-4090-NSNN	4061.70	4351.24
	96"(2438mm)	16.5"(419mm)	X4UD-4096-NSNN	4232.99	4536.37

# Masters Series

## Vertical Storage Units Open

### Vertical Storage Unit — 2H Open Features

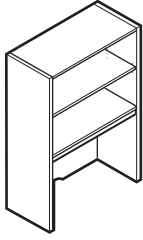

30" and 36" widths

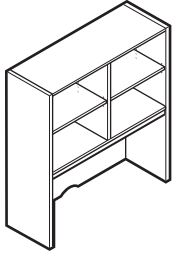

42", 48" and 54" widths

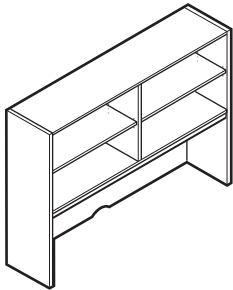

60", 66" and 72" widths

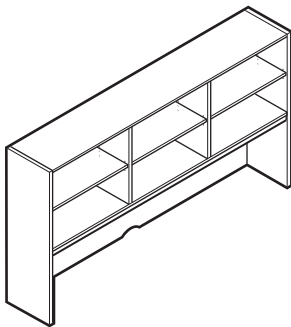

78", 84", 90" and 96" widths

X4UL-NN  
X4UD-NN  
X5UL-NN  
X5UD-NN

- Includes storage cabinet(s) with 2"(51mm) integrated light valance, one adjustable shelf, vertical supports and attachment material.
- 23.375"(594mm) clearance between top of worksurface and bottom of light valance.
- Standard unfinished two-piece back.
- The underside of the cabinet and front of lower section:
  - Laminate - the underside of the cabinet and front of lower section is finished.
  - Wood - the underside of the cabinet is finished, the lower section is unfinished.
- One interior .75"(19mm) wood shelf with ±1.25"(32mm) adjustment range.
- Unfinished clearcoat wireway scallop in bottom center of back panel.
- Shipped assembled.

### Specification Tips

- Not for use on a freestanding or standalone desk.
- Designed to stack on equal width credenza, 2H storage cabinet or 2H lateral file. Refer to Stack-on Application Rules in Specification Guide.
- Accommodates separately specified tackboards and lighting accessories. Tackboard will block the ability to drop cords down or bring power to the surface. Use field installed grommets for power access.
- Aligns with 6H storage units.
- Wood units are not designed for applications where the back of unit is visible.

### To Order, Specify:

- 1) Product number.
- 2) Finish code (laminate or wood).
- 3) Laminate edge trim color (if laminate specified).



# Masters Series

Vertical Storage Units Open

Height	Width	Depth	Number	Laminate	
				A	B
<b>Laminate — Letter Depth</b>					
52.5"(1334mm)	30"(762mm)	14"(356mm)	X5UL-5230-NSNN	\$1764.93	\$1843.85
	36"(914mm)	14"(356mm)	X5UL-5236-NSNN	1910.91	2001.71
	42"(1067mm)	14"(356mm)	X5UL-5242-NSNN	2073.28	2175.96
	48"(1219mm)	14"(356mm)	X5UL-5248-NSNN	2219.26	2333.82
	54"(1372mm)	14"(356mm)	X5UL-5254-NSNN	2365.24	2491.68
	60"(1524mm)	14"(356mm)	X5UL-5260-NSNN	2511.22	2649.54
	66"(1676mm)	14"(356mm)	X5UL-5266-NSNN	2657.20	2807.40
	72"(1829mm)	14"(356mm)	X5UL-5272-NSNN	2803.18	2965.26
	78"(1981mm)	14"(356mm)	X5UL-5278-NSNN	2965.55	3139.51
	84"(2134mm)	14"(356mm)	X5UL-5284-NSNN	3111.53	3297.37
	90"(2286mm)	14"(356mm)	X5UL-5290-NSNN	3257.51	3455.23
	96"(2438mm)	14"(356mm)	X5UL-5296-NSNN	3403.49	3613.09

<b>Laminate — Legal Depth</b>					
52.5"(1334mm)	30"(762mm)	16.5"(419mm)	X5UD-5230-NSNN	\$1913.86	\$2004.69
	36"(914mm)	16.5"(419mm)	X5UD-5236-NSNN	2059.84	2162.55
	42"(1067mm)	16.5"(419mm)	X5UD-5242-NSNN	2222.21	2336.80
	48"(1219mm)	16.5"(419mm)	X5UD-5248-NSNN	2368.19	2494.66
	54"(1372mm)	16.5"(419mm)	X5UD-5254-NSNN	2514.17	2652.52
	60"(1524mm)	16.5"(419mm)	X5UD-5260-NSNN	2660.15	2810.38
	66"(1676mm)	16.5"(419mm)	X5UD-5266-NSNN	2806.13	2968.24
	72"(1829mm)	16.5"(419mm)	X5UD-5272-NSNN	2952.11	3126.10
	78"(1981mm)	16.5"(419mm)	X5UD-5278-NSNN	3114.48	3300.35
	84"(2134mm)	16.5"(419mm)	X5UD-5284-NSNN	3260.46	3458.21
	90"(2286mm)	16.5"(419mm)	X5UD-5290-NSNN	3406.44	3616.07
	96"(2438mm)	16.5"(419mm)	X5UD-5296-NSNN	3552.42	3773.93

Height	Width	Depth	Number	Wood	
				Group A	Group B
<b>Wood — Letter Depth</b>					
52.5"(1334mm)	30"(762mm)	14"(356mm)	X4UL-5230-NSNN	\$2487.30	\$2655.59
	36"(914mm)	14"(356mm)	X4UL-5236-NSNN	2710.71	2897.99
	42"(1067mm)	14"(356mm)	X4UL-5242-NSNN	2950.51	3156.78
	48"(1219mm)	14"(356mm)	X4UL-5248-NSNN	3173.92	3399.18
	54"(1372mm)	14"(356mm)	X4UL-5254-NSNN	3397.33	3641.58
	60"(1524mm)	14"(356mm)	X4UL-5260-NSNN	3620.74	3883.98
	66"(1676mm)	14"(356mm)	X4UL-5266-NSNN	3844.15	4126.38
	72"(1829mm)	14"(356mm)	X4UL-5272-NSNN	4067.56	4368.78
	78"(1981mm)	14"(356mm)	X4UL-5278-NSNN	4307.36	4627.57
	84"(2134mm)	14"(356mm)	X4UL-5284-NSNN	4530.77	4869.97
	90"(2286mm)	14"(356mm)	X4UL-5290-NSNN	4754.18	5112.37
	96"(2438mm)	14"(356mm)	X4UL-5296-NSNN	4977.59	5354.77

<b>Wood — Legal Depth</b>					
52.5"(1334mm)	30"(762mm)	16.5"(419mm)	X4UD-5230-NSNN	\$2688.38	\$2876.74
	36"(914mm)	16.5"(419mm)	X4UD-5236-NSNN	2911.79	3119.14
	42"(1067mm)	16.5"(419mm)	X4UD-5242-NSNN	3151.59	3377.93
	48"(1219mm)	16.5"(419mm)	X4UD-5248-NSNN	3375.00	3620.33
	54"(1372mm)	16.5"(419mm)	X4UD-5254-NSNN	3598.41	3862.73
	60"(1524mm)	16.5"(419mm)	X4UD-5260-NSNN	3821.82	4105.13
	66"(1676mm)	16.5"(419mm)	X4UD-5266-NSNN	4045.23	4347.53
	72"(1829mm)	16.5"(419mm)	X4UD-5272-NSNN	4268.64	4589.93
	78"(1981mm)	16.5"(419mm)	X4UD-5278-NSNN	4508.44	4848.72
	84"(2134mm)	16.5"(419mm)	X4UD-5284-NSNN	4731.85	5091.12
	90"(2286mm)	16.5"(419mm)	X4UD-5290-NSNN	4955.26	5333.52
	96"(2438mm)	16.5"(419mm)	X4UD-5296-NSNN	5178.67	5575.92

# Masters Series

## Vertical Storage Units with Hinged Doors

### Vertical Storage Unit — 1H with Hinged Doors

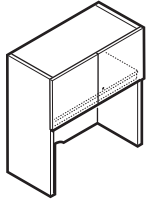

X4VL-NW  
X4VD-NW  
X5VL-NL  
X5VD-NL  
30" and 36" widths

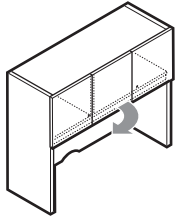

X4VL-LW  
X4VD-LW  
X5VL-LL  
X5VD-LL  
42", 48" and 54" widths  
(Left-hand single door swing shown)

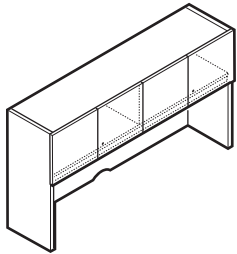

X4VL-NW  
X4VD-NW  
X5VL-NL  
X5VD-NL  
60", 66" and 72" widths

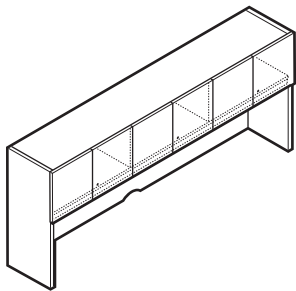

X4VL-NW  
X4VD-NW  
X5VL-NL  
X5VD-NL  
78", 84", 90" and 96" widths

### Features

- Includes storage cabinet(s) with hinged doors, 2"(51 mm) integrated light valance, vertical supports and attachment material.
- 42"(1067mm), 48"(1219mm) and 54"(1372mm) wide units available with choice of left or right door swing for single door.
- Optional locks available; each pair of doors and each single door lock separately.
- Common keys within each unit.
- Lock plug is available in black or chrome.
- For lock options, refer to Lock Program section of the Accessories Price List.
- 23.375"(594mm) clearance between top of worksurface and bottom of light valance.
- Standard unfinished two-piece back.
- The underside of the cabinet and front of lower section:
  - Laminate - the underside of the cabinet and front of lower section is finished.
  - Wood - the underside of the cabinet is finished, the lower section is unfinished.
- Unfinished clearcoat wireway scallop in bottom center of back panel.
- Shipped assembled.

### Specification Tips

- Not for use on a freestanding or standalone desk.
- Designed to stack on equal width credenza, 2H storage cabinet or 2H lateral file. Refer to Stack-on Application Rules in Specification Guide.
- Accommodates separately specified tackboards and lighting accessories. Tackboard will block the ability to drop cords down or bring power to the surface. Use field installed grommets for power access.
- Aligns with 5H storage units.
- Wood units are not designed for applications where the back of unit is visible.

### To Order, Specify:

- 1) Product number, including:

#### 1 Lock Option:

- N** No Lock
- L** Lock
  - 30"-36", add **\$169.05** list
  - 42"-72", add **\$338.10** list
  - 78"-96", add **\$507.16** list

#### 2 Single Door Swing Orientation:

(42", 48" and 54" wide only)

- L** Left-hand
- R** Right-hand

- 2) Finish code (laminate or wood).
- 3) Laminate edge trim color (if laminate specified).
- 4) Trim color for lock (if specified).

## Masters Series

Vertical Storage Units with Hinged Doors

Height	Width	Actual Depth	Number ① ②	Laminate	
				A	B
<b>Laminate — Letter Depth</b>					
39.9"(1013mm)	30"(762mm)	14.8"(376mm)	X5VL-4030- SNL	\$1884.07	\$1972.84
	36"(914mm)	14.8"(376mm)	X5VL-4036- SNL	2013.21	2112.38
	42"(1067mm)	14.8"(376mm)	X5VL-4042- S L	2158.74	2268.31
	48"(1219mm)	14.8"(376mm)	X5VL-4048- S L	2287.88	2407.85
	54"(1372mm)	14.8"(376mm)	X5VL-4054- S L	2417.02	2547.39
	60"(1524mm)	14.8"(376mm)	X5VL-4060- SNL	2546.16	2686.93
	66"(1676mm)	14.8"(376mm)	X5VL-4066- SNL	2675.30	2826.47
	72"(1829mm)	14.8"(376mm)	X5VL-4072- SNL	2804.44	2966.01
	78"(1981mm)	14.8"(376mm)	X5VL-4078- SNL	2949.97	3121.94
	84"(2134mm)	14.8"(376mm)	X5VL-4084- SNL	3079.11	3261.48
	90"(2286mm)	14.8"(376mm)	X5VL-4090- SNL	3208.25	3401.02
	96"(2438mm)	14.8"(376mm)	X5VL-4096- SNL	3337.39	3540.56

<b>Laminate — Legal Depth</b>					
39.9"(1013mm)	30"(762mm)	17.3"(439mm)	X5VD-4030- SNL	\$2033.00	\$2133.68
	36"(914mm)	17.3"(439mm)	X5VD-4036- SNL	2162.14	2273.22
	42"(1067mm)	17.3"(439mm)	X5VD-4042- S L	2307.67	2429.15
	48"(1219mm)	17.3"(439mm)	X5VD-4048- S L	2436.81	2568.69
	54"(1372mm)	17.3"(439mm)	X5VD-4054- S L	2565.95	2708.23
	60"(1524mm)	17.3"(439mm)	X5VD-4060- SNL	2695.09	2847.77
	66"(1676mm)	17.3"(439mm)	X5VD-4066- SNL	2824.23	2987.31
	72"(1829mm)	17.3"(439mm)	X5VD-4072- SNL	2953.37	3126.85
	78"(1981mm)	17.3"(439mm)	X5VD-4078- SNL	3098.90	3282.78
	84"(2134mm)	17.3"(439mm)	X5VD-4084- SNL	3228.04	3422.32
	90"(2286mm)	17.3"(439mm)	X5VD-4090- SNL	3357.18	3561.86
	96"(2438mm)	17.3"(439mm)	X5VD-4096- SNL	3486.32	3701.40

Height	Width	Actual Depth	Number ① ②	Wood	
				Group A	Group B
<b>Wood — Letter Depth</b>					
39.9"(1013mm)	30"(762mm)	14.8"(376mm)	X4VL-4030- SNW	\$2710.71	\$2977.31
	36"(914mm)	14.8"(376mm)	X4VL-4036- SNW	2908.82	3194.82
	42"(1067mm)	14.8"(376mm)	X4VL-4042- S W	3123.32	3428.72
	48"(1219mm)	14.8"(376mm)	X4VL-4048- S W	3321.43	3646.23
	54"(1372mm)	14.8"(376mm)	X4VL-4054- S W	3519.54	3863.74
	60"(1524mm)	14.8"(376mm)	X4VL-4060- SNW	3717.65	4081.25
	66"(1676mm)	14.8"(376mm)	X4VL-4066- SNW	3915.76	4298.76
	72"(1829mm)	14.8"(376mm)	X4VL-4072- SNW	4113.87	4516.27
	78"(1981mm)	14.8"(376mm)	X4VL-4078- SNW	4328.37	4750.17
	84"(2134mm)	14.8"(376mm)	X4VL-4084- SNW	4526.48	4967.68
	90"(2286mm)	14.8"(376mm)	X4VL-4090- SNW	4724.59	5185.19
	96"(2438mm)	14.8"(376mm)	X4VL-4096- SNW	4922.70	5402.70

<b>Wood — Legal Depth</b>					
39.9"(1013mm)	30"(762mm)	17.3"(439mm)	X4VD-4030- SNW	\$2911.79	\$3198.46
	36"(914mm)	17.3"(439mm)	X4VD-4036- SNW	3109.90	3415.97
	42"(1067mm)	17.3"(439mm)	X4VD-4042- S W	3324.40	3649.87
	48"(1219mm)	17.3"(439mm)	X4VD-4048- S W	3522.51	3867.38
	54"(1372mm)	17.3"(439mm)	X4VD-4054- S W	3720.62	4084.89
	60"(1524mm)	17.3"(439mm)	X4VD-4060- SNW	3918.73	4302.40
	66"(1676mm)	17.3"(439mm)	X4VD-4066- SNW	4116.84	4519.91
	72"(1829mm)	17.3"(439mm)	X4VD-4072- SNW	4314.95	4737.42
	78"(1981mm)	17.3"(439mm)	X4VD-4078- SNW	4529.45	4971.32
	84"(2134mm)	17.3"(439mm)	X4VD-4084- SNW	4727.56	5188.83
	90"(2286mm)	17.3"(439mm)	X4VD-4090- SNW	4925.67	5406.34
	96"(2438mm)	17.3"(439mm)	X4VD-4096- SNW	5123.78	5623.85

# Masters Series

## Vertical Storage Units with Hinged Doors

### Vertical Storage Unit — 2H with Hinged Doors

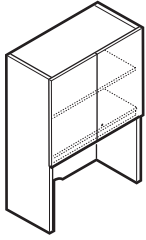

X4VL-NW  
X4VD-NW  
X5VL-NL  
X5VD-NL  
30" and 36" widths

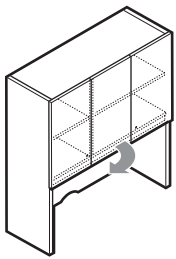

X4VL-LW  
X4VD-LW  
X5VL-LL  
X5VD-LL  
42", 48" and 54" widths  
(Left-hand single door swing shown)

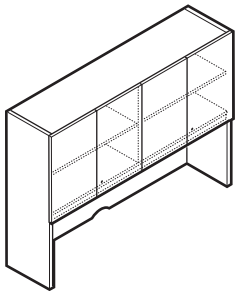

X4VL-NW  
X4VD-NW  
X5VL-NL  
X5VD-NL  
60", 66" and 72" widths

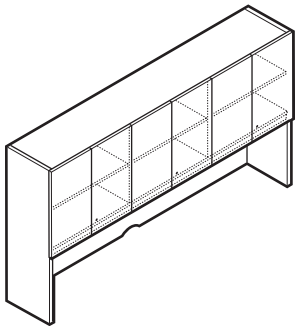

X4VL-NW  
X4VD-NW  
X5VL-NL  
X5VD-NL  
78", 84", 90" and 96" widths

### Features

- Includes storage cabinet(s) with hinged doors, 2"(51mm) integrated light valance, one adjustable shelf, vertical supports and attachment material.
- 42"(1067mm), 48"(1219mm) and 54"(1372mm) wide units available with choice of left or right door swing for single door.
- Optional locks available; each pair of doors and each single door lock separately.
- Lock plug is available in black or chrome.
- Common keys within each unit.
- For lock options, refer to Lock Program section of the Accessories Price List.
- 23.375"(594mm) clearance between top of worksurface and bottom of light valance.
- Standard unfinished two-piece back.
- The underside of the cabinet and front of lower section:
  - Laminate - the underside of the cabinet and front of lower section is finished.
  - Wood - the underside of the cabinet is finished, the lower section is unfinished.
- One interior .75"(19mm) thick wood shelf with  $\pm 1.25$ "(32mm) adjustment range.
- Unfinished clearcoat wireway scallop in bottom center of back panel.
- Shipped assembled.

### Specification Tips

- Not for use on a freestanding or standalone desk.
- Designed to stack on equal width credenza, 2H storage cabinet or 2H lateral file. Refer to Stack-on Application Rules in Specification Guide.
- Accommodates separately specified tackboards and lighting accessories. Tackboard will block the ability to drop cords down or bring power to the surface. Use field installed grommets for power access.
- Aligns with 6H storage units.
- Wood units are not designed for applications where the back of unit is visible.

### To Order, Specify:

- 1) Product number, including:

#### ① Lock Option:

- N** No Lock
- L** Lock  
30"-36", add **\$169.05** list  
42"-72", add **\$338.10** list  
78"-96", add **\$507.16** list

#### ② Single Door Swing Orientation:

(42", 48" and 54" wide only)

- L** Left-hand
- R** Right-hand

- 2) Finish code (laminate or wood).
- 3) Laminate edge trim color (if laminate specified).
- 4) Trim color for lock (if specified).

**Masters Series**

Vertical Storage Units with Hinged Doors

Height	Width	Actual Depth	Number ① ②	Laminate	
				A	B
<b>Laminate — Letter Depth</b>					
52.5"(1334mm)	30"(762mm)	14.8"(376mm)	X5VL-5230- SNL	\$2371.84	\$2498.54
	36"(914mm)	14.8"(376mm)	X5VL-5236- SNL	2535.26	2675.31
	42"(1067mm)	14.8"(376mm)	X5VL-5242- S L	2715.07	2868.47
	48"(1219mm)	14.8"(376mm)	X5VL-5248- S L	2878.49	3045.24
	54"(1372mm)	14.8"(376mm)	X5VL-5254- S L	3041.91	3222.01
	60"(1524mm)	14.8"(376mm)	X5VL-5260- SNL	3205.33	3398.78
	66"(1676mm)	14.8"(376mm)	X5VL-5266- SNL	3368.75	3575.55
	72"(1829mm)	14.8"(376mm)	X5VL-5272- SNL	3532.17	3752.32
	78"(1981mm)	14.8"(376mm)	X5VL-5278- SNL	3711.98	3945.48
	84"(2134mm)	14.8"(376mm)	X5VL-5284- SNL	3875.40	4122.25
	90"(2286mm)	14.8"(376mm)	X5VL-5290- SNL	4038.82	4299.02
	96"(2438mm)	14.8"(376mm)	X5VL-5296- SNL	4202.24	4475.79
<b>Laminate — Legal Depth</b>					
52.5"(1334mm)	30"(762mm)	17.3"(439mm)	X5VD-5230- SNL	\$2520.77	\$2659.38
	36"(914mm)	17.3"(439mm)	X5VD-5236- SNL	2684.19	2836.15
	42"(1067mm)	17.3"(439mm)	X5VD-5242- S L	2864.00	3029.31
	48"(1219mm)	17.3"(439mm)	X5VD-5248- S L	3027.42	3206.08
	54"(1372mm)	17.3"(439mm)	X5VD-5254- S L	3190.84	3382.85
	60"(1524mm)	17.3"(439mm)	X5VD-5260- SNL	3354.26	3559.62
	66"(1676mm)	17.3"(439mm)	X5VD-5266- SNL	3517.68	3736.39
	72"(1829mm)	17.3"(439mm)	X5VD-5272- SNL	3681.10	3913.16
	78"(1981mm)	17.3"(439mm)	X5VD-5278- SNL	3860.91	4106.32
	84"(2134mm)	17.3"(439mm)	X5VD-5284- SNL	4024.33	4283.09
	90"(2286mm)	17.3"(439mm)	X5VD-5290- SNL	4187.75	4459.86
	96"(2438mm)	17.3"(439mm)	X5VD-5296- SNL	4351.17	4636.63
<b>Wood — Letter Depth</b>					
52.5"(1334mm)	30"(762mm)	14.8"(376mm)	X4VL-5230- SNW	\$3455.43	\$3796.47
	36"(914mm)	14.8"(376mm)	X4VL-5236- SNW	3705.66	4071.25
	42"(1067mm)	14.8"(376mm)	X4VL-5242- S W	3972.28	4362.42
	48"(1219mm)	14.8"(376mm)	X4VL-5248- S W	4222.51	4637.20
	54"(1372mm)	14.8"(376mm)	X4VL-5254- S W	4472.74	4911.98
	60"(1524mm)	14.8"(376mm)	X4VL-5260- SNW	4722.97	5186.76
	66"(1676mm)	14.8"(376mm)	X4VL-5266- SNW	4973.20	5461.54
	72"(1829mm)	14.8"(376mm)	X4VL-5272- SNW	5223.43	5736.32
	78"(1981mm)	14.8"(376mm)	X4VL-5278- SNW	5490.05	6027.49
	84"(2134mm)	14.8"(376mm)	X4VL-5284- SNW	5740.28	6302.27
	90"(2286mm)	14.8"(376mm)	X4VL-5290- SNW	5990.51	6577.05
	96"(2438mm)	14.8"(376mm)	X4VL-5296- SNW	6240.74	6851.83
<b>Wood — Legal Depth</b>					
52.5"(1334mm)	30"(762mm)	17.3"(439mm)	X4VD-5230- SNW	\$3656.51	\$4017.62
	36"(914mm)	17.3"(439mm)	X4VD-5236- SNW	3906.74	4292.40
	42"(1067mm)	17.3"(439mm)	X4VD-5242- S W	4173.36	4583.57
	48"(1219mm)	17.3"(439mm)	X4VD-5248- S W	4423.59	4858.35
	54"(1372mm)	17.3"(439mm)	X4VD-5254- S W	4673.82	5133.13
	60"(1524mm)	17.3"(439mm)	X4VD-5260- SNW	4924.05	5407.91
	66"(1676mm)	17.3"(439mm)	X4VD-5266- SNW	5174.28	5682.69
	72"(1829mm)	17.3"(439mm)	X4VD-5272- SNW	5424.51	5957.47
	78"(1981mm)	17.3"(439mm)	X4VD-5278- SNW	5691.13	6248.64
	84"(2134mm)	17.3"(439mm)	X4VD-5284- SNW	5941.36	6523.42
	90"(2286mm)	17.3"(439mm)	X4VD-5290- SNW	6191.59	6798.20
	96"(2438mm)	17.3"(439mm)	X4VD-5296- SNW	6441.82	7072.98

# Masters Series

## Vertical Storage Units with Sliding Door

### Vertical Storage Unit — 1H with Sliding Door

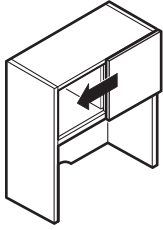

30" and 36" widths

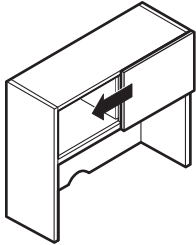

42", 48" and 54" widths

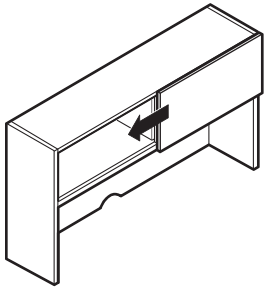

60", 66" and 72" widths

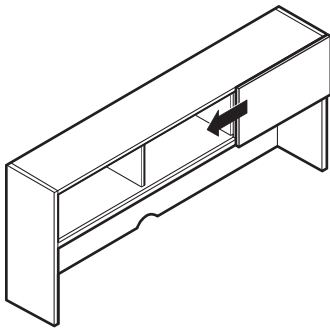

X4RL-NW  
X4RD-NW  
X5RL-NL  
X5RD-NL  
78", 84", 90" and 96" widths

### Features

- Includes storage cabinet(s) with one sliding door, 2" (51 mm) integrated light valance, vertical supports and attachment material.
- Units 30"-72" (762mm-1829mm) wide include two equal width sections divided by one inset intermediate center support.
- Units 78"-96" (1981mm-2438mm) wide include three equal width sections divided by two inset intermediate center supports.
- Sliding door width is equal to one section width (one-half or one-third of unit width).
- Includes internally mounted sliding door track top and bottom with bumpers at each end.
- Locks not available.
- 23.375" (594mm) clearance between top of worksurface and bottom of light valance.
- Standard unfinished two-piece back.
- The underside of the cabinet and front of lower section:
  - Laminate - the underside of the cabinet and front of lower section is finished.
  - Wood - the underside of the cabinet is finished, the lower section is unfinished.
- Unfinished clearcoat wireway scallop in bottom center of back panel.
- Shipped assembled.

### Specification Tips

- Not for use on a freestanding or standalone desk.
- Designed to stack on equal width credenza, 2H storage cabinet or 2H lateral file. Refer to Stack-on Application Rules in Specification Guide.
- Accommodates separately specified tackboards and lighting accessories. Tackboard will block the ability to drop cords down or bring power to the surface. Use field installed grommets for power access.
- Aligns with 5H storage units.
- Wood units are not designed for applications where the back of unit is visible.

### To Order, Specify:

- 1) Product number.
- 2) Finish code (laminate or wood).
- 3) Laminate edge trim color (if laminate specified).

**Masters Series**

Vertical Storage Units with Sliding Door

Height	Width	Actual Depth	Number	Laminate	
				A	B
<b>Laminate — Letter Depth</b>					
39.9"(1013mm)	30"(762mm)	14.8"(376mm)	X5RL-4030-NSNL	\$1761.18	\$1839.33
	36"(914mm)	14.8"(376mm)	X5RL-4036-NSNL	1877.72	1965.19
	42"(1067mm)	14.8"(376mm)	X5RL-4042-NSNL	2010.65	2107.44
	48"(1219mm)	14.8"(376mm)	X5RL-4048-NSNL	2127.19	2233.30
	54"(1372mm)	14.8"(376mm)	X5RL-4054-NSNL	2243.73	2359.16
	60"(1524mm)	14.8"(376mm)	X5RL-4060-NSNL	2360.27	2485.02
	66"(1676mm)	14.8"(376mm)	X5RL-4066-NSNL	2476.81	2610.88
	72"(1829mm)	14.8"(376mm)	X5RL-4072-NSNL	2593.35	2736.74
	78"(1981mm)	14.8"(376mm)	X5RL-4078-NSNL	2726.28	2878.99
	84"(2134mm)	14.8"(376mm)	X5RL-4084-NSNL	2842.82	3004.85
	90"(2286mm)	14.8"(376mm)	X5RL-4090-NSNL	2959.36	3130.71
	96"(2438mm)	14.8"(376mm)	X5RL-4096-NSNL	3075.90	3256.57
<b>Laminate — Legal Depth</b>					
39.9"(1013mm)	30"(762mm)	17.3"(439mm)	X5RD-4030-NSNL	\$1910.11	\$2000.17
	36"(914mm)	17.3"(439mm)	X5RD-4036-NSNL	2026.65	2126.03
	42"(1067mm)	17.3"(439mm)	X5RD-4042-NSNL	2159.58	2268.28
	48"(1219mm)	17.3"(439mm)	X5RD-4048-NSNL	2276.12	2394.14
	54"(1372mm)	17.3"(439mm)	X5RD-4054-NSNL	2392.66	2520.00
	60"(1524mm)	17.3"(439mm)	X5RD-4060-NSNL	2509.20	2645.86
	66"(1676mm)	17.3"(439mm)	X5RD-4066-NSNL	2625.74	2771.72
	72"(1829mm)	17.3"(439mm)	X5RD-4072-NSNL	2742.28	2897.58
	78"(1981mm)	17.3"(439mm)	X5RD-4078-NSNL	2875.21	3039.83
	84"(2134mm)	17.3"(439mm)	X5RD-4084-NSNL	2991.75	3165.69
	90"(2286mm)	17.3"(439mm)	X5RD-4090-NSNL	3108.29	3291.55
	96"(2438mm)	17.3"(439mm)	X5RD-4096-NSNL	3224.83	3417.41
Height	Width	Actual Depth	Number	Wood	
				Group A	Group B
<b>Wood — Letter Depth</b>					
39.9"(1013mm)	30"(762mm)	14.8"(376mm)	X4RL-4030-NSNW	\$2487.30	\$2736.01
	36"(914mm)	14.8"(376mm)	X4RL-4036-NSNW	2666.05	2932.60
	42"(1067mm)	14.8"(376mm)	X4RL-4042-NSNW	2861.19	3145.58
	48"(1219mm)	14.8"(376mm)	X4RL-4048-NSNW	3039.94	3342.17
	54"(1372mm)	14.8"(376mm)	X4RL-4054-NSNW	3218.69	3538.76
	60"(1524mm)	14.8"(376mm)	X4RL-4060-NSNW	3397.44	3735.35
	66"(1676mm)	14.8"(376mm)	X4RL-4066-NSNW	3576.19	3931.94
	72"(1829mm)	14.8"(376mm)	X4RL-4072-NSNW	3754.94	4128.53
	78"(1981mm)	14.8"(376mm)	X4RL-4078-NSNW	3950.08	4341.51
	84"(2134mm)	14.8"(376mm)	X4RL-4084-NSNW	4128.83	4538.10
	90"(2286mm)	14.8"(376mm)	X4RL-4090-NSNW	4307.58	4734.69
	96"(2438mm)	14.8"(376mm)	X4RL-4096-NSNW	4486.33	4931.28
<b>Wood — Legal Depth</b>					
39.9"(1013mm)	30"(762mm)	17.3"(439mm)	X4RD-4030-NSNW	\$2688.38	\$2957.16
	36"(914mm)	17.3"(439mm)	X4RD-4036-NSNW	2867.13	3153.75
	42"(1067mm)	17.3"(439mm)	X4RD-4042-NSNW	3062.27	3366.73
	48"(1219mm)	17.3"(439mm)	X4RD-4048-NSNW	3241.02	3563.32
	54"(1372mm)	17.3"(439mm)	X4RD-4054-NSNW	3419.77	3759.91
	60"(1524mm)	17.3"(439mm)	X4RD-4060-NSNW	3598.52	3956.50
	66"(1676mm)	17.3"(439mm)	X4RD-4066-NSNW	3777.27	4153.09
	72"(1829mm)	17.3"(439mm)	X4RD-4072-NSNW	3956.02	4349.68
	78"(1981mm)	17.3"(439mm)	X4RD-4078-NSNW	4151.16	4562.66
	84"(2134mm)	17.3"(439mm)	X4RD-4084-NSNW	4329.91	4759.25
	90"(2286mm)	17.3"(439mm)	X4RD-4090-NSNW	4508.66	4955.84
	96"(2438mm)	17.3"(439mm)	X4RD-4096-NSNW	4687.41	5152.43

# Masters Series

## Vertical Storage Units with Sliding Door

### Vertical Storage Unit — 2H with Sliding Door

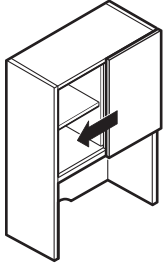

30" and 36" widths

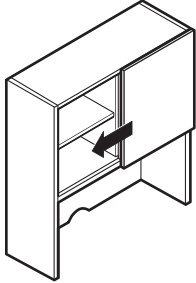

42", 48" and 54" widths

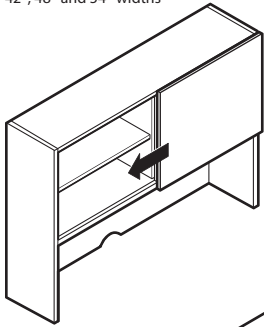

60", 66" and 72" widths

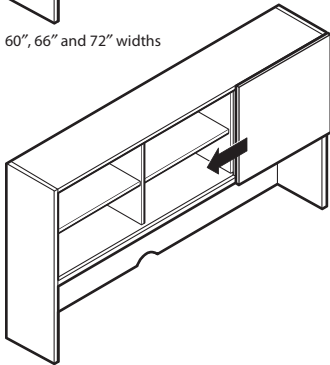

78", 84", 90" and 96" widths

X4RL-NW  
X4RD-NW  
X5RL-NL  
X5RD-NL

### Features

- Includes storage cabinet(s) with one sliding door, 2"(51mm) integrated light valance, one adjustable shelf, vertical supports and attachment material.
- Units 30"-72"(762mm-1829mm) wide include two equal width sections divided by one inset intermediate center support.
- Units 78"-96"(1981mm-2438mm) wide include three equal width sections divided by two inset intermediate center supports.
- Sliding door width is equal to one section width (one-half or one-third of unit width).
- Includes internally mounted sliding door track top and bottom with bumpers at each end.
- Locks not available.
- 23.375"(594mm) clearance between top of worksurface and bottom of light valance.
- Standard unfinished two-piece back.
- The underside of the cabinet and front of lower section:
  - Laminate - the underside of the cabinet and front of lower section is finished.
  - Wood - the underside of the cabinet is finished, the lower section is unfinished.
- Unfinished clearcoat wireway scallop in bottom center of back panel.
- One interior .75"(19mm) thick wood shelf with  $\pm 1.25"$ (32mm) adjustment range.
- Shipped assembled.

### Specification Tips

- Not for use on a freestanding or standalone desk.
- Designed to stack on equal width credenza, 2H storage cabinet or 2H lateral file. Refer to Stack-on Application Rules in Specification Guide.
- Accommodates separately specified tackboards and lighting accessories. Tackboard will block the ability to drop cords down or bring power to the surface. Use field installed grommets for power access.
- Aligns with 6H storage units.
- Wood units are not designed for applications where the back of unit is visible.

### To Order, Specify:

- 1) Product number.
- 2) Finish code (laminate or wood).
- 3) Laminate edge trim color (if laminate specified).



**Masters Series**

Vertical Storage Units with Sliding Door

Height	Width	Actual Depth	Number	Laminate	
				A	B
<b>Laminate — Letter Depth</b>					
52.5"(1334mm)	30"(762mm)	14.8"(376mm)	X5RL-5230-NSNL	\$2055.36	\$2156.71
	36"(914mm)	14.8"(376mm)	X5RL-5236-NSNL	2206.18	2319.80
	42"(1067mm)	14.8"(376mm)	X5RL-5242-NSNL	2373.39	2499.28
	48"(1219mm)	14.8"(376mm)	X5RL-5248-NSNL	2524.21	2662.37
	54"(1372mm)	14.8"(376mm)	X5RL-5254-NSNL	2675.03	2825.46
	60"(1524mm)	14.8"(376mm)	X5RL-5260-NSNL	2825.85	2988.55
	66"(1676mm)	14.8"(376mm)	X5RL-5266-NSNL	2976.67	3151.64
	72"(1829mm)	14.8"(376mm)	X5RL-5272-NSNL	3127.49	3314.73
	78"(1981mm)	14.8"(376mm)	X5RL-5278-NSNL	3294.70	3494.21
	84"(2134mm)	14.8"(376mm)	X5RL-5284-NSNL	3445.52	3657.30
	90"(2286mm)	14.8"(376mm)	X5RL-5290-NSNL	3596.34	3820.39
	96"(2438mm)	14.8"(376mm)	X5RL-5296-NSNL	3747.16	3983.48

<b>Laminate — Legal Depth</b>					
52.5"(1334mm)	30"(762mm)	17.3"(439mm)	X5RD-5230-NSNL	\$2204.29	\$2317.55
	36"(914mm)	17.3"(439mm)	X5RD-5236-NSNL	2355.11	2480.64
	42"(1067mm)	17.3"(439mm)	X5RD-5242-NSNL	2522.32	2660.12
	48"(1219mm)	17.3"(439mm)	X5RD-5248-NSNL	2673.14	2823.21
	54"(1372mm)	17.3"(439mm)	X5RD-5254-NSNL	2823.96	2986.30
	60"(1524mm)	17.3"(439mm)	X5RD-5260-NSNL	2974.78	3149.39
	66"(1676mm)	17.3"(439mm)	X5RD-5266-NSNL	3125.60	3312.48
	72"(1829mm)	17.3"(439mm)	X5RD-5272-NSNL	3276.42	3475.57
	78"(1981mm)	17.3"(439mm)	X5RD-5278-NSNL	3443.63	3655.05
	84"(2134mm)	17.3"(439mm)	X5RD-5284-NSNL	3594.45	3818.14
	90"(2286mm)	17.3"(439mm)	X5RD-5290-NSNL	3745.27	3981.23
	96"(2438mm)	17.3"(439mm)	X5RD-5296-NSNL	3896.09	4144.32

Height	Width	Actual Depth	Number	Wood	
				Group A	Group B
<b>Wood — Letter Depth</b>					
52.5"(1334mm)	30"(762mm)	14.8"(376mm)	X4RL-5230-NSNW	\$2934.14	\$3224.53
	36"(914mm)	14.8"(376mm)	X4RL-5236-NSNW	3165.01	3478.39
	42"(1067mm)	14.8"(376mm)	X4RL-5242-NSNW	3412.27	3748.64
	48"(1219mm)	14.8"(376mm)	X4RL-5248-NSNW	3643.14	4002.50
	54"(1372mm)	14.8"(376mm)	X4RL-5254-NSNW	3874.01	4256.36
	60"(1524mm)	14.8"(376mm)	X4RL-5260-NSNW	4104.88	4510.22
	66"(1676mm)	14.8"(376mm)	X4RL-5266-NSNW	4335.75	4764.08
	72"(1829mm)	14.8"(376mm)	X4RL-5272-NSNW	4566.62	5017.94
	78"(1981mm)	14.8"(376mm)	X4RL-5278-NSNW	4813.88	5288.19
	84"(2134mm)	14.8"(376mm)	X4RL-5284-NSNW	5044.75	5542.05
	90"(2286mm)	14.8"(376mm)	X4RL-5290-NSNW	5275.62	5795.91
	96"(2438mm)	14.8"(376mm)	X4RL-5296-NSNW	5506.49	6049.77

<b>Wood — Legal Depth</b>					
52.5"(1334mm)	30"(762mm)	17.3"(439mm)	X4RD-5230-NSNW	\$3135.22	\$3445.68
	36"(914mm)	17.3"(439mm)	X4RD-5236-NSNW	3366.09	3699.54
	42"(1067mm)	17.3"(439mm)	X4RD-5242-NSNW	3613.35	3969.79
	48"(1219mm)	17.3"(439mm)	X4RD-5248-NSNW	3844.22	4223.65
	54"(1372mm)	17.3"(439mm)	X4RD-5254-NSNW	4075.09	4477.51
	60"(1524mm)	17.3"(439mm)	X4RD-5260-NSNW	4305.96	4731.37
	66"(1676mm)	17.3"(439mm)	X4RD-5266-NSNW	4536.83	4985.23
	72"(1829mm)	17.3"(439mm)	X4RD-5272-NSNW	4767.70	5239.09
	78"(1981mm)	17.3"(439mm)	X4RD-5278-NSNW	5014.96	5509.34
	84"(2134mm)	17.3"(439mm)	X4RD-5284-NSNW	5245.83	5763.20
	90"(2286mm)	17.3"(439mm)	X4RD-5290-NSNW	5476.70	6017.06
	96"(2438mm)	17.3"(439mm)	X4RD-5296-NSNW	5707.57	6270.92

# Masters Series

## Vertical Storage Units with Glass Hinged Doors

### Vertical Storage Unit — 1H with Glass Hinged Doors

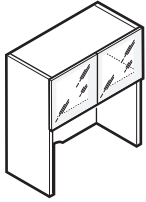

X45L-NT  
X45D-NT  
X55L-NT  
X55D-NT  
30" and 36" widths

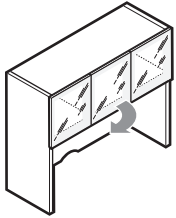

X45L-LT  
X45D-LT  
X55L-LT  
X55D-LT  
42", 48" and 54" widths  
(Left-hand single swing door shown)

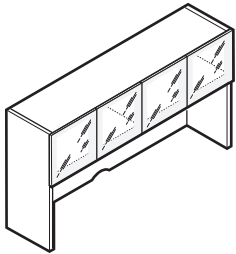

X45L-NT  
X45D-NT  
X55L-NT  
X55D-NT  
60", 66" and 72" widths

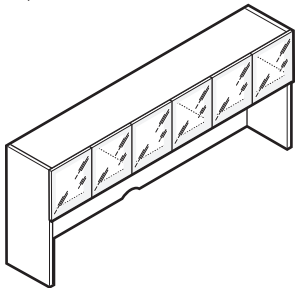

X45L-NT  
X45D-NT  
X55L-NT  
X55D-NT  
78", 84", 90" and 96" widths

### Features

- Includes storage cabinet(s) with glass doors, 2"(51mm) integrated light valance, vertical supports and attachment material.
- 42"(1067mm), 48"(1219mm) and 54"(1372mm) wide units available with choice of left or right door swing for single door.
- 23.375"(594mm) clearance between top of worksurface and bottom of light valance.
- Locks not available.
- Glass door includes metal frame with metallic powdercoat finish on back side of door.
- The underside of the cabinet and front of lower section:
  - Laminate - the underside of the cabinet and front of lower section is finished.
  - Wood - the underside of the cabinet is finished, the lower section is unfinished.
- Standard unfinished two-piece back.
- Unfinished clearcoat wireway scallop in bottom center of back panel.
- Glass doors will be field installed.

### Specification Tips

- Not for use on a freestanding or standalone desk.
- Designed to stack on equal width credenza, 2H storage cabinet or 2H lateral file. Refer to Stack-on Application Rules in Specification Guide.
- Accommodates separately specified tackboards and lighting accessories. Tackboard will block the ability to drop cords down or bring power to the surface. Use field installed grommets for power access.
- Aligns with 5H storage units.
- Wood units are not designed for applications where the back of unit is visible.

### To Order, Specify:

- 1) Product number, including:

#### ① Single Door Swing Orientation: (42", 48" and 54" wide only)

**L** Left-hand

**R** Right-hand

- 2) Finish code (laminated or wood).
- 3) Laminate edge trim color (if laminate specified).
- 4) Glass code.
- 5) Trim color for glass frame (required - metallic paint only).

## Masters Series

Vertical Storage Units with Glass Hinged Doors

Height	Width	Depth	Number ①	Laminate A Glass				Laminate B Glass				
				A	C	D	F	A	C	D	F	
<b>Letter Depth</b>												
39.875"(1013mm)	30"(762mm)	14"(356mm)	X5SL-4030-NSNT	\$2375.00	\$2640.79	\$2818.14	\$3060.08	\$2434.57	\$2700.36	\$2877.71	\$3119.65	
	36"(914mm)	14"(356mm)	X5SL-4036-NSNT	2528.78	2807.67	2993.73	3245.46	2597.28	2876.17	3062.23	3313.96	
	42"(1067mm)	14"(356mm)	X5SL-4042-NS T	2698.95	2990.94	3185.71	3447.23	2776.38	3068.37	3263.14	3524.66	
	48"(1219mm)	14"(356mm)	X5SL-4048-NS T	2852.73	3157.82	3361.30	3632.61	2939.09	3244.18	3447.66	3718.97	
	54"(1372mm)	14"(356mm)	X5SL-4054-NS T	3006.51	3324.70	3536.89	3817.99	3101.80	3419.99	3632.18	3913.28	
	60"(1524mm)	14"(356mm)	X5SL-4060-NSNT	3160.29	3491.58	3712.48	4003.37	3264.51	3595.80	3816.70	4107.59	
	66"(1676mm)	14"(356mm)	X5SL-4066-NSNT	3314.07	3658.46	3888.07	4188.75	3427.22	3771.61	4001.22	4301.90	
	72"(1829mm)	14"(356mm)	X5SL-4072-NSNT	3467.85	3825.34	4063.66	4374.13	3589.93	3947.42	4185.74	4496.21	
	78"(1981mm)	14"(356mm)	X5SL-4078-NSNT	3638.02	4008.61	4255.64	4575.90	3769.03	4139.62	4386.65	4706.91	
	84"(2134mm)	14"(356mm)	X5SL-4084-NSNT	3791.80	4175.49	4431.23	4761.28	3931.74	4315.43	4571.17	4901.22	
	90"(2286mm)	14"(356mm)	X5SL-4090-NSNT	3945.58	4342.37	4606.82	4946.66	4094.45	4491.24	4755.69	5095.53	
	96"(2438mm)	14"(356mm)	X5SL-4096-NSNT	4099.36	4509.25	4782.41	5132.04	4257.16	4667.05	4940.21	5289.84	
<b>Legal Depth</b>												
39.875"(1013mm)	30"(762mm)	16.5"(419mm)	X5SD-4030-NSNT	\$2523.93	\$2789.72	\$2967.07	\$3209.01	\$2595.41	\$2861.20	\$3038.55	\$3280.49	
	36"(914mm)	16.5"(419mm)	X5SD-4036-NSNT	2677.71	2956.60	3142.66	3394.39	2758.12	3037.01	3223.07	3474.80	
	42"(1067mm)	16.5"(419mm)	X5SD-4042-NS T	2847.88	3139.87	3334.64	3596.16	2937.22	3229.21	3423.98	3685.50	
	48"(1219mm)	16.5"(419mm)	X5SD-4048-NS T	3001.66	3306.75	3510.23	3781.54	3099.93	3405.02	3608.50	3879.81	
	54"(1372mm)	16.5"(419mm)	X5SD-4054-NS T	3155.44	3473.63	3685.82	3966.92	3262.64	3580.83	3793.02	4074.12	
	60"(1524mm)	16.5"(419mm)	X5SD-4060-NSNT	3309.22	3640.51	3861.41	4152.30	3425.35	3756.64	3977.54	4268.43	
	66"(1676mm)	16.5"(419mm)	X5SD-4066-NSNT	3463.00	3807.39	4037.00	4337.68	3588.06	3932.45	4162.06	4462.74	
	72"(1829mm)	16.5"(419mm)	X5SD-4072-NSNT	3616.78	3974.27	4212.59	4523.06	3750.77	4108.26	4346.58	4657.05	
	78"(1981mm)	16.5"(419mm)	X5SD-4078-NSNT	3786.95	4157.54	4404.57	4724.83	3929.87	4300.46	4547.49	4867.75	
	84"(2134mm)	16.5"(419mm)	X5SD-4084-NSNT	3940.73	4324.42	4580.16	4910.21	4092.58	4476.27	4732.01	5062.06	
	90"(2286mm)	16.5"(419mm)	X5SD-4090-NSNT	4094.51	4491.30	4755.75	5095.59	4255.29	4652.08	4916.53	5256.37	
	96"(2438mm)	16.5"(419mm)	X5SD-4096-NSNT	4248.29	4658.18	4931.34	5280.97	4418.00	4827.89	5101.05	5450.68	

Height	Width	Depth	Number ①	Wood Group A Glass				Wood Group B Glass				
				A	C	D	F	A	C	D	F	
<b>Letter Depth</b>												
39.875"(1013mm)	30"(762mm)	14"(356mm)	X4SL-4030-NSNT	\$2970.77	\$3236.56	\$3413.91	\$3655.85	\$3101.84	\$3367.63	\$3544.98	\$3786.92	
	36"(914mm)	14"(356mm)	X4SL-4036-NSNT	3184.14	3463.03	3649.09	3900.82	3329.05	3607.94	3794.00	4045.73	
	42"(1067mm)	14"(356mm)	X4SL-4042-NS T	3413.90	3705.89	3900.66	4162.18	3572.65	3864.64	4059.41	4320.93	
	48"(1219mm)	14"(356mm)	X4SL-4048-NS T	3627.27	3932.36	4135.84	4407.15	3799.86	4104.95	4308.43	4579.74	
	54"(1372mm)	14"(356mm)	X4SL-4054-NS T	3840.64	4158.83	4371.02	4652.12	4027.07	4345.26	4557.45	4838.55	
	60"(1524mm)	14"(356mm)	X4SL-4060-NSNT	4054.01	4385.30	4606.20	4897.09	4254.28	4585.57	4806.47	5097.36	
	66"(1676mm)	14"(356mm)	X4SL-4066-NSNT	4267.38	4611.77	4841.38	5142.06	4481.49	4825.88	5055.49	5356.17	
	72"(1829mm)	14"(356mm)	X4SL-4072-NSNT	4480.75	4838.24	5076.56	5387.03	4708.70	5066.19	5304.51	5614.98	
	78"(1981mm)	14"(356mm)	X4SL-4078-NSNT	4710.51	5081.10	5328.13	5648.39	4952.30	5322.89	5569.92	5890.18	
	84"(2134mm)	14"(356mm)	X4SL-4084-NSNT	4923.88	5307.57	5563.31	5893.36	5179.51	5563.20	5818.94	6148.99	
	90"(2286mm)	14"(356mm)	X4SL-4090-NSNT	5137.25	5534.04	5798.49	6138.33	5406.72	5803.51	6067.96	6407.80	
	96"(2438mm)	14"(356mm)	X4SL-4096-NSNT	5350.62	5760.51	6033.67	6383.30	5633.93	6043.82	6316.98	6666.61	
<b>Legal Depth</b>												
39.875"(1013mm)	30"(762mm)	16.5"(419mm)	X4SD-4030-NSNT	\$3171.85	\$3437.64	\$3614.99	\$3856.93	\$3322.99	\$3588.78	\$3766.13	\$4008.07	
	36"(914mm)	16.5"(419mm)	X4SD-4036-NSNT	3385.22	3664.11	3850.17	4101.90	3550.20	3829.09	4015.15	4266.88	
	42"(1067mm)	16.5"(419mm)	X4SD-4042-NS T	3614.98	3906.97	4101.74	4363.26	3793.80	4085.79	4280.56	4542.08	
	48"(1219mm)	16.5"(419mm)	X4SD-4048-NS T	3828.35	4133.44	4336.92	4608.23	4021.01	4326.10	4529.58	4800.89	
	54"(1372mm)	16.5"(419mm)	X4SD-4054-NS T	4041.72	4359.91	4572.10	4853.20	4248.22	4566.41	4778.60	5059.70	
	60"(1524mm)	16.5"(419mm)	X4SD-4060-NSNT	4255.09	4586.38	4807.28	5098.17	4475.43	4806.72	5027.62	5318.51	
	66"(1676mm)	16.5"(419mm)	X4SD-4066-NSNT	4468.46	4812.85	5042.46	5343.14	4702.64	5047.03	5276.64	5577.32	
	72"(1829mm)	16.5"(419mm)	X4SD-4072-NSNT	4681.83	5039.32	5277.64	5588.11	4929.85	5287.34	5525.66	5836.13	
	78"(1981mm)	16.5"(419mm)	X4SD-4078-NSNT	4911.59	5282.18	5529.21	5849.47	5173.45	5544.04	5791.07	6111.33	
	84"(2134mm)	16.5"(419mm)	X4SD-4084-NSNT	5124.96	5508.65	5764.39	6094.44	5400.66	5784.35	6040.09	6370.14	
	90"(2286mm)	16.5"(419mm)	X4SD-4090-NSNT	5338.33	5735.12	5999.57	6339.41	5627.87	6024.66	6289.11	6628.95	
	96"(2438mm)	16.5"(419mm)	X4SD-4096-NSNT	5551.70	5961.59	6234.75	6584.38	5855.08	6264.97	6538.13	6887.76	

# Masters Series

## Vertical Storage Units with Glass Hinged Doors

### Vertical Storage Unit — 2H with Glass Hinged Doors

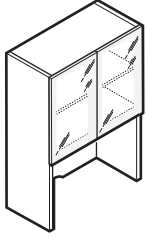

X45L-NT  
X45D-NT  
X55L-NT  
X55D-NT  
30" and 36" widths

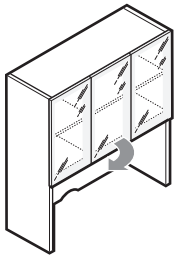

X45L-LT  
X45D-LT  
X55L-LT  
X55D-LT  
42", 48" and 54" widths  
(Left-hand single swing door shown)

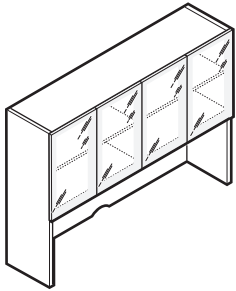

X45L-NT  
X45D-NT  
X55L-NT  
X55D-NT  
60", 66" and 72" widths

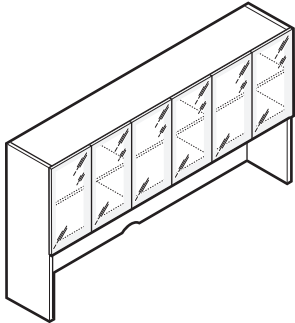

X45L-NT  
X45D-NT  
X55L-NT  
X55D-NT  
78", 84", 90" and 96" widths

### Features

- Includes storage cabinet(s) with glass doors, 2"(51mm) integrated light valance, one adjustable shelf, vertical supports and attachment material.
- 42"(1067mm), 48"(1219mm) and 54"(1372mm) wide units available with choice of left or right door swing for single door.
- 23.375"(594mm) clearance between top of worksurface and bottom of light valance.
- Locks not available.
- Glass door includes metal frame with metallic powdercoat finish on back side of door.
- The underside of the cabinet and front of lower section:
  - Laminate - the underside of the cabinet and front of lower section is finished.
  - Wood - the underside of the cabinet is finished, the lower section is unfinished.
- Standard unfinished two-piece back.
- Unfinished clearcoat wireway scallop in bottom center of back panel.
- One interior .75"(19mm) thick wood shelf with  $\pm 1.25$ "(32mm) adjustment range.
- Glass doors will be field installed.

### Specification Tips

- Not for use on a freestanding or standalone desk.
- Designed to stack on equal width credenza, 2H storage cabinet or 2H lateral file. Refer to Stack-on Application Rules in Specification Guide.
- Accommodates separately specified tackboards and lighting accessories. Tackboard will block the ability to drop cords down or bring power to the surface. Use field installed grommets for power access.
- Aligns with 6H storage units.
- Wood units are not designed for applications where the back of unit is visible.

### To Order, Specify:

- 1) Product number, including:

#### ❶ Single Door Swing Orientation: (42", 48" and 54" wide only)

**L** Left-hand

**R** Right-hand

- 2) Finish code (laminate or wood).
- 3) Laminate edge trim color (if laminate specified).
- 4) Glass code.
- 5) Trim color for glass frame (required - metallic paint only).

# Masters Series

Vertical Storage Units with Glass Hinged Doors

Height	Width	Depth	Number ①	Laminate A Glass				Laminate B Glass			
				A	C	D	F	A	C	D	F
<b>Letter Depth</b>											
52.5"(1334mm)	30"(762mm)	14"(356mm)	X5SL-5230-NSNT	\$3179.85	\$3619.27	\$3912.46	\$4284.26	\$3258.77	\$3698.19	\$3991.38	\$4363.18
	36"(914mm)	14"(356mm)	X5SL-5236-NSNT	3367.91	3820.43	4122.33	4503.92	3458.71	3911.23	4213.13	4594.72
	42"(1067mm)	14"(356mm)	X5SL-5242-NS T	3572.36	4037.98	4348.59	4739.97	3675.04	4140.66	4451.27	4842.65
	48"(1219mm)	14"(356mm)	X5SL-5248-NS T	3760.42	4239.14	4558.46	4959.63	3874.98	4353.70	4673.02	5074.19
	54"(1372mm)	14"(356mm)	X5SL-5254-NS T	3948.48	4440.30	4768.33	5179.29	4074.92	4566.74	4894.77	5305.73
	60"(1524mm)	14"(356mm)	X5SL-5260-NSNT	4136.54	4641.46	4978.20	5398.95	4274.86	4779.78	5116.52	5537.27
	66"(1676mm)	14"(356mm)	X5SL-5266-NSNT	4324.60	4842.62	5188.07	5618.61	4474.80	4992.82	5338.27	5768.81
	72"(1829mm)	14"(356mm)	X5SL-5272-NSNT	4512.66	5043.78	5397.94	5838.27	4674.74	5205.86	5560.02	6000.35
	78"(1981mm)	14"(356mm)	X5SL-5278-NSNT	4717.11	5261.33	5624.20	6074.32	4891.07	5435.29	5798.16	6248.28
	84"(2134mm)	14"(356mm)	X5SL-5284-NSNT	4905.17	5462.49	5834.07	6293.98	5091.01	5648.33	6019.91	6479.82
	90"(2286mm)	14"(356mm)	X5SL-5290-NSNT	5093.23	5663.65	6043.94	6513.64	5290.95	5861.37	6241.66	6711.36
	96"(2438mm)	14"(356mm)	X5SL-5296-NSNT	5281.29	5864.81	6253.81	6733.30	5490.89	6074.41	6463.41	6942.90
<b>Legal Depth</b>											
52.5"(1334mm)	30"(762mm)	16.5"(419mm)	X5SD-5230-NSNT	\$3328.78	\$3768.20	\$4061.39	\$4433.19	\$3419.61	\$3859.03	\$4152.22	\$4524.02
	36"(914mm)	16.5"(419mm)	X5SD-5236-NSNT	3516.84	3969.36	4271.26	4652.85	3619.55	4072.07	4373.97	4755.56
	42"(1067mm)	16.5"(419mm)	X5SD-5242-NS T	3721.29	4186.91	4497.52	4888.90	3835.88	4301.50	4612.11	5003.49
	48"(1219mm)	16.5"(419mm)	X5SD-5248-NS T	3909.35	4388.07	4707.39	5108.56	4035.82	4514.54	4833.86	5235.03
	54"(1372mm)	16.5"(419mm)	X5SD-5254-NS T	4097.41	4589.23	4917.26	5328.22	4235.76	4727.58	5055.61	5466.57
	60"(1524mm)	16.5"(419mm)	X5SD-5260-NSNT	4285.47	4790.39	5127.13	5547.88	4435.70	4940.62	5277.36	5698.11
	66"(1676mm)	16.5"(419mm)	X5SD-5266-NSNT	4473.53	4991.55	5337.00	5767.54	4635.64	5153.66	5499.11	5929.65
	72"(1829mm)	16.5"(419mm)	X5SD-5272-NSNT	4661.59	5192.71	5546.87	5987.20	4835.58	5366.70	5720.86	6161.19
	78"(1981mm)	16.5"(419mm)	X5SD-5278-NSNT	4866.04	5410.26	5773.13	6223.25	5051.91	5596.13	5959.00	6409.12
	84"(2134mm)	16.5"(419mm)	X5SD-5284-NSNT	5054.10	5611.42	5983.00	6442.91	5251.85	5809.17	6180.75	6640.66
	90"(2286mm)	16.5"(419mm)	X5SD-5290-NSNT	5242.16	5812.58	6192.87	6662.57	5451.79	6022.21	6402.50	6872.20
	96"(2438mm)	16.5"(419mm)	X5SD-5296-NSNT	5430.22	6013.74	6402.74	6882.23	5651.73	6235.25	6624.25	7103.74

Height	Width	Depth	Number ①	Wood Group A Glass				Wood Group B Glass			
				A	C	D	F	A	C	D	F
<b>Letter Depth</b>											
52.5"(1334mm)	30"(762mm)	14"(356mm)	X4SL-5230-NSNT	\$3902.22	\$4341.64	\$4634.83	\$5006.63	\$4070.51	\$4509.93	\$4803.12	\$5174.92
	36"(914mm)	14"(356mm)	X4SL-5236-NSNT	4167.71	4620.23	4922.13	5303.72	4354.99	4807.51	5109.41	5491.00
	42"(1067mm)	14"(356mm)	X4SL-5242-NS T	4449.59	4915.21	5225.82	5617.20	4655.86	5121.48	5432.09	5823.47
	48"(1219mm)	14"(356mm)	X4SL-5248-NS T	4715.08	5193.80	5513.12	5914.29	4940.34	5419.06	5738.38	6139.55
	54"(1372mm)	14"(356mm)	X4SL-5254-NS T	4980.57	5472.39	5800.42	6211.38	5224.82	5716.64	6044.67	6455.63
	60"(1524mm)	14"(356mm)	X4SL-5260-NSNT	5246.06	5750.98	6087.72	6508.47	5509.30	6014.22	6350.96	6771.71
	66"(1676mm)	14"(356mm)	X4SL-5266-NSNT	5511.55	6029.57	6375.02	6805.56	5793.78	6311.80	6657.25	7087.79
	72"(1829mm)	14"(356mm)	X4SL-5272-NSNT	5777.04	6308.16	6662.32	7102.65	6078.26	6609.38	6963.54	7403.87
	78"(1981mm)	14"(356mm)	X4SL-5278-NSNT	6058.92	6603.14	6966.01	7416.13	6379.13	6923.35	7286.22	7736.34
	84"(2134mm)	14"(356mm)	X4SL-5284-NSNT	6324.41	6881.73	7253.31	7713.22	6663.61	7220.93	7592.51	8052.42
	90"(2286mm)	14"(356mm)	X4SL-5290-NSNT	6589.90	7160.32	7540.61	8010.31	6948.09	7518.51	7898.80	8368.50
	96"(2438mm)	14"(356mm)	X4SL-5296-NSNT	6855.39	7438.91	7827.91	8307.40	7232.57	7816.09	8205.09	8684.58
<b>Legal Depth</b>											
52.5"(1334mm)	30"(762mm)	16.5"(419mm)	X4SD-5230-NSNT	\$4103.30	\$4542.72	\$4835.91	\$5207.71	\$4291.66	\$4731.08	\$5024.27	\$5396.07
	36"(914mm)	16.5"(419mm)	X4SD-5236-NSNT	4368.79	4821.31	5123.21	5504.80	4576.14	5028.66	5330.56	5712.15
	42"(1067mm)	16.5"(419mm)	X4SD-5242-NS T	4650.67	5116.29	5426.90	5818.28	4877.01	5342.63	5653.24	6044.62
	48"(1219mm)	16.5"(419mm)	X4SD-5248-NS T	4916.16	5394.88	5714.20	6115.37	5161.49	5640.21	5959.53	6360.70
	54"(1372mm)	16.5"(419mm)	X4SD-5254-NS T	5181.65	5673.47	6001.50	6412.46	5445.97	5937.79	6265.82	6676.78
	60"(1524mm)	16.5"(419mm)	X4SD-5260-NSNT	5447.14	5952.06	6288.80	6709.55	5730.45	6235.37	6572.11	6992.86
	66"(1676mm)	16.5"(419mm)	X4SD-5266-NSNT	5712.63	6230.65	6576.10	7006.64	6014.93	6532.95	6878.40	7308.94
	72"(1829mm)	16.5"(419mm)	X4SD-5272-NSNT	5978.12	6509.24	6863.40	7303.73	6299.41	6830.53	7184.69	7625.02
	78"(1981mm)	16.5"(419mm)	X4SD-5278-NSNT	6260.00	6804.22	7167.09	7617.21	6600.28	7144.50	7507.37	7957.49
	84"(2134mm)	16.5"(419mm)	X4SD-5284-NSNT	6525.49	7082.81	7454.39	7914.30	6884.76	7442.08	7813.66	8273.57
	90"(2286mm)	16.5"(419mm)	X4SD-5290-NSNT	6790.98	7361.40	7741.69	8211.39	7169.24	7739.66	8119.95	8589.65
	96"(2438mm)	16.5"(419mm)	X4SD-5296-NSNT	7056.47	7639.99	8028.99	8508.48	7453.72	8037.24	8426.24	8905.73

# Masters Series

## Vertical Storage Units with Glass Sliding Door

### Vertical Storage Unit — 1H with Glass Sliding Door

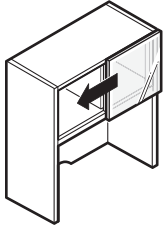

30" and 36" widths

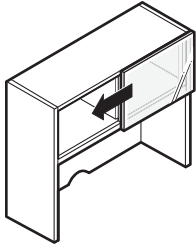

42", 48" and 54" widths

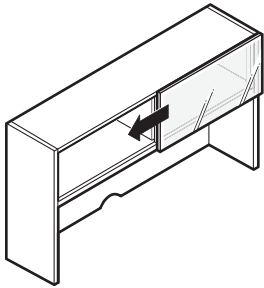

60", 66" and 72" widths

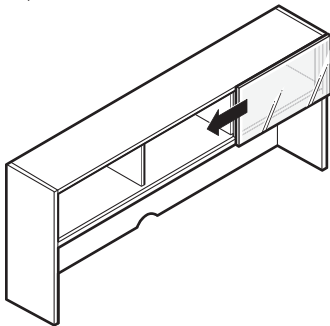

78", 84", 90" and 96" widths

X4L-NT  
X4L-NT  
X5L-NT  
X5L-NT

### Features

- Includes storage cabinet(s) with one glass sliding door, 2"(51mm) integrated light valance, vertical supports and attachment material.
- Units 30"-72"(762mm-1829mm) wide include two equal width sections divided by one inset intermediate center support.
- Units 78"-96"(1981mm-2438mm) wide include three equal width sections divided by two inset intermediate center supports.
- Locks not available.
- Glass door includes metal frame with metallic powdercoat finish on back side of door.
- Includes internally mounted sliding door track top and bottom with bumpers at each end.
- 23.375"(594mm) clearance between top of worksurface and bottom of light valance.
- The underside of the cabinet and front of lower section:
  - Laminate - the underside of the cabinet and front of lower section is finished.
  - Wood - the underside of the cabinet is finished, the lower section is unfinished.
- Standard unfinished two-piece back.
- Unfinished clearcoat wireway scallop in bottom center of back panel.
- Glass doors will be field installed.

### Specification Tips

- Not for use on a freestanding or standalone desk.
- Designed to stack on equal width credenza, 2H storage cabinet or 2H lateral file. Refer to Stack-on Application Rules in Specification Guide.
- Accommodates separately specified tackboards and lighting accessories. Tackboard will block the ability to drop cords down or bring power to the surface. Use field installed grommets for power access.
- Aligns with 5H storage units.
- Only back-painted glass available as standard; specifying alternate glass may allow for the light valance and hardware to be visible.
- Wood units are not designed for applications where the back of unit is visible.

### To Order, Specify:

- 1) Product number.
- 2) Finish code (laminate or wood).
- 3) Laminate edge trim color (if laminate specified).
- 4) Glass code.
- 5) Trim color for glass frame (required - metallic paint only).

## Masters Series

Vertical Storage Units with Glass Sliding Door

Height	Width	Depth	Number	Laminate A Glass				Laminate B Glass			
				A	C	D	F	A	C	D	F
<b>Letter Depth</b>											
39.875"(1013mm)	30"(762mm)	14"(356mm)	X5LL-4030-NSNT	\$2141.59	\$2334.90	\$2463.84	\$2608.39	\$2201.16	\$2394.47	\$2523.41	\$2667.96
	36"(914mm)	14"(356mm)	X5LL-4036-NSNT	2290.32	2495.13	2631.75	2786.75	2358.82	2563.63	2700.25	2855.25
	42"(1067mm)	14"(356mm)	X5LL-4042-NSNT	2455.44	2671.75	2816.05	2981.50	2532.87	2749.18	2893.48	3058.93
	48"(1219mm)	14"(356mm)	X5LL-4048-NSNT	2604.17	2831.98	2983.96	3159.86	2690.53	2918.34	3070.32	3246.22
	54"(1372mm)	14"(356mm)	X5LL-4054-NSNT	2752.90	2992.21	3151.87	3338.22	2848.19	3087.50	3247.16	3433.51
	60"(1524mm)	14"(356mm)	X5LL-4060-NSNT	2901.63	3152.44	3319.78	3516.58	3005.85	3256.66	3424.00	3620.80
	66"(1676mm)	14"(356mm)	X5LL-4066-NSNT	3050.36	3312.67	3487.69	3694.94	3163.51	3425.82	3600.84	3808.09
	72"(1829mm)	14"(356mm)	X5LL-4072-NSNT	3199.09	3472.90	3655.60	3873.30	3321.17	3594.98	3777.68	3995.38
	78"(1981mm)	14"(356mm)	X5LL-4078-NSNT	3364.21	3649.52	3839.90	4068.05	3495.22	3780.53	3970.91	4199.06
	84"(2134mm)	14"(356mm)	X5LL-4084-NSNT	3512.94	3809.75	4007.81	4246.41	3652.88	3949.69	4147.75	4386.35
	90"(2286mm)	14"(356mm)	X5LL-4090-NSNT	3661.67	3969.98	4175.72	4424.77	3810.54	4118.85	4324.59	4573.64
	96"(2438mm)	14"(356mm)	X5LL-4096-NSNT	3810.40	4130.21	4343.63	4603.13	3968.20	4288.01	4501.43	4760.93
<b>Legal Depth</b>											
39.875"(1013mm)	30"(762mm)	16.5"(419mm)	X5LD-4030-NSNT	\$2290.52	\$2483.83	\$2612.77	\$2757.32	\$2362.00	\$2555.31	\$2684.25	\$2828.80
	36"(914mm)	16.5"(419mm)	X5LD-4036-NSNT	2439.25	2644.06	2780.68	2935.68	2519.66	2724.47	2861.09	3016.09
	42"(1067mm)	16.5"(419mm)	X5LD-4042-NSNT	2604.37	2820.68	2964.98	3130.43	2693.71	2910.02	3054.32	3219.77
	48"(1219mm)	16.5"(419mm)	X5LD-4048-NSNT	2753.10	2980.91	3132.89	3308.79	2851.37	3079.18	3231.16	3407.06
	54"(1372mm)	16.5"(419mm)	X5LD-4054-NSNT	2901.83	3141.14	3300.80	3487.15	3009.03	3248.34	3408.00	3594.35
	60"(1524mm)	16.5"(419mm)	X5LD-4060-NSNT	3050.56	3301.37	3468.71	3665.51	3166.69	3417.50	3584.84	3781.64
	66"(1676mm)	16.5"(419mm)	X5LD-4066-NSNT	3199.29	3461.60	3636.62	3843.87	3324.35	3586.66	3761.68	3968.93
	72"(1829mm)	16.5"(419mm)	X5LD-4072-NSNT	3348.02	3621.83	3804.53	4022.23	3482.01	3755.82	3938.52	4156.22
	78"(1981mm)	16.5"(419mm)	X5LD-4078-NSNT	3513.14	3798.45	3988.83	4216.98	3656.06	3941.37	4131.75	4359.90
	84"(2134mm)	16.5"(419mm)	X5LD-4084-NSNT	3661.87	3958.68	4156.74	4395.34	3813.72	4110.53	4308.59	4547.19
	90"(2286mm)	16.5"(419mm)	X5LD-4090-NSNT	3810.60	4118.91	4324.65	4573.70	3971.38	4279.69	4485.43	4734.48
	96"(2438mm)	16.5"(419mm)	X5LD-4096-NSNT	3959.33	4279.14	4492.56	4752.06	4129.04	4448.85	4662.27	4921.77

Height	Width	Depth	Number	Wood Group A Glass				Wood Group B Glass			
				A	C	D	F	A	C	D	F
<b>Letter Depth</b>											
39.875"(1013mm)	30"(762mm)	14"(356mm)	X4LL-4030-NSNT	\$2737.36	\$2930.67	\$3059.61	\$3204.16	\$2868.43	\$3061.74	\$3190.68	\$3335.23
	36"(914mm)	14"(356mm)	X4LL-4036-NSNT	2945.68	3150.49	3287.11	3442.11	3090.59	3295.40	3432.02	3587.02
	42"(1067mm)	14"(356mm)	X4LL-4042-NSNT	3170.39	3386.70	3531.00	3696.45	3329.14	3545.45	3689.75	3855.20
	48"(1219mm)	14"(356mm)	X4LL-4048-NSNT	3378.71	3606.52	3758.50	3934.40	3551.30	3779.11	3931.09	4106.99
	54"(1372mm)	14"(356mm)	X4LL-4054-NSNT	3587.03	3826.34	3986.00	4172.35	3773.46	4012.77	4172.43	4358.78
	60"(1524mm)	14"(356mm)	X4LL-4060-NSNT	3795.35	4046.16	4213.50	4410.30	3995.62	4246.43	4413.77	4610.57
	66"(1676mm)	14"(356mm)	X4LL-4066-NSNT	4003.67	4265.98	4441.00	4648.25	4217.78	4480.09	4655.11	4862.36
	72"(1829mm)	14"(356mm)	X4LL-4072-NSNT	4211.99	4485.80	4668.50	4886.20	4439.94	4713.75	4896.45	5114.15
	78"(1981mm)	14"(356mm)	X4LL-4078-NSNT	4436.70	4722.01	4912.39	5140.54	4678.49	4963.80	5154.18	5382.33
	84"(2134mm)	14"(356mm)	X4LL-4084-NSNT	4645.02	4941.83	5139.89	5378.49	4900.65	5197.46	5395.52	5634.12
	90"(2286mm)	14"(356mm)	X4LL-4090-NSNT	4853.34	5161.65	5367.39	5616.44	5122.81	5431.12	5636.86	5885.91
	96"(2438mm)	14"(356mm)	X4LL-4096-NSNT	5061.66	5381.47	5594.89	5854.39	5344.97	5664.78	5878.20	6137.70
<b>Legal Depth</b>											
39.875"(1013mm)	30"(762mm)	16.5"(419mm)	X4LD-4030-NSNT	\$2938.44	\$3131.75	\$3260.69	\$3405.24	\$3089.58	\$3282.89	\$3411.83	\$3556.38
	36"(914mm)	16.5"(419mm)	X4LD-4036-NSNT	3146.76	3351.57	3488.19	3643.19	3311.74	3516.55	3653.17	3808.17
	42"(1067mm)	16.5"(419mm)	X4LD-4042-NSNT	3371.47	3587.78	3732.08	3897.53	3550.29	3766.60	3910.90	4076.35
	48"(1219mm)	16.5"(419mm)	X4LD-4048-NSNT	3579.79	3807.60	3959.58	4135.48	3772.45	4000.26	4152.24	4328.14
	54"(1372mm)	16.5"(419mm)	X4LD-4054-NSNT	3788.11	4027.42	4187.08	4373.43	3994.61	4233.92	4393.58	4579.93
	60"(1524mm)	16.5"(419mm)	X4LD-4060-NSNT	3996.43	4247.24	4414.58	4611.38	4216.77	4467.58	4634.92	4831.72
	66"(1676mm)	16.5"(419mm)	X4LD-4066-NSNT	4204.75	4467.06	4642.08	4849.33	4438.93	4701.24	4876.26	5083.51
	72"(1829mm)	16.5"(419mm)	X4LD-4072-NSNT	4413.07	4686.88	4869.58	5087.28	4661.09	4934.90	5117.60	5335.30
	78"(1981mm)	16.5"(419mm)	X4LD-4078-NSNT	4637.78	4923.09	5113.47	5341.62	4899.64	5184.95	5375.33	5603.48
	84"(2134mm)	16.5"(419mm)	X4LD-4084-NSNT	4846.10	5142.91	5340.97	5579.57	5121.80	5418.61	5616.67	5855.27
	90"(2286mm)	16.5"(419mm)	X4LD-4090-NSNT	5054.42	5362.73	5568.47	5817.52	5343.96	5652.27	5858.01	6107.06
	96"(2438mm)	16.5"(419mm)	X4LD-4096-NSNT	5262.74	5582.55	5795.97	6055.47	5566.12	5885.93	6099.35	6358.85

# Masters Series

## Vertical Storage Units with Glass Sliding Door

### Vertical Storage Unit — 2H with Glass Sliding Door

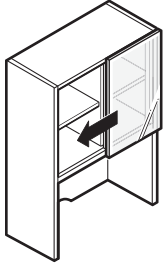

30" and 36" widths

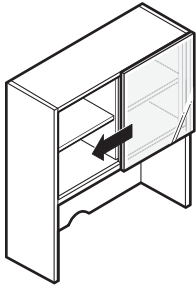

42", 48" and 54" widths

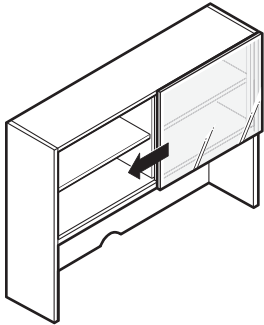

60", 66" and 72" widths

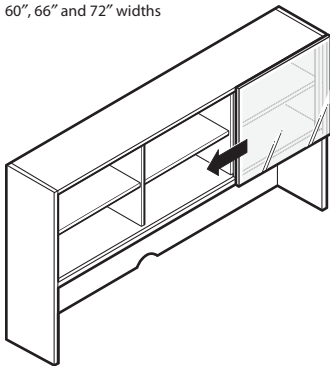

78", 84", 90" and 96" widths  
X4LL-NT  
X4LD-NT  
X5LL-NT  
X5LD-NT

### Features

- Includes storage cabinet(s) with one glass sliding door, 2"(51mm) integrated light valance, one adjustable shelf, vertical supports and attachment material.
- Unfinished clearcoat wireway scallop in bottom center of back panel.
- Units 30"-72"(762mm-1829mm) wide include two equal width sections divided by one inset intermediate center support.
- Units 78"-96"(1981mm-2438mm) wide include three equal width sections divided by two inset intermediate center supports.
- Sliding door width is equal to one section width (one-half or one-third of unit width).
- Locks not available.
- Glass door includes metal frame with metallic powdercoat finish on back side of door.
- Includes internally mounted sliding door track top and bottom with bumpers at each end.
- 23.375"(594mm) clearance between top of worksurface and bottom of light valance.
- The underside of the cabinet and front of lower section:
  - Laminate - the underside of the cabinet and front of lower section is finished.
  - Wood - the underside of the cabinet is finished, the lower section is unfinished.
- Standard unfinished two-piece back.
- One interior .75"(19mm) thick wood shelf with  $\pm 1.25"$ (32mm) adjustment range.
- Glass doors will be field installed.

### Specification Tips

- Not for use on a freestanding or standalone desk.
- Designed to stack on equal width credenza, 2H storage cabinet or 2H lateral file. Refer to Stack-on Application Rules in Specification Guide.
- Accommodates separately specified tackboards and lighting accessories. Tackboard will block the ability to drop cords down or bring power to the surface. Use field installed grommets for power access.
- Aligns with 6H storage units.
- Only back-painted glass available as standard; specifying alternate glass may allow for the light valance and hardware to be visible.
- Wood units are not designed for applications where the back of unit is visible.

### To Order, Specify:

- 1) Product number.
- 2) Finish code (laminate or wood).
- 3) Laminate edge trim color (if laminate specified).
- 4) Glass code.
- 5) Trim color for glass frame (required - metallic paint only).



## Masters Series

Vertical Storage Units with Glass Sliding Door

Height	Width	Depth	Number	Laminate A Glass				Laminate B Glass			
				A	C	D	F	A	C	D	F
<b>Letter Depth</b>											
52.5"(1334mm)	30"(762mm)	14"(356mm)	X5LL-5230-NSNT	\$2754.24	\$3061.49	\$3266.49	\$3514.59	\$2833.16	\$3140.41	\$3345.41	\$3593.51
	36"(914mm)	14"(356mm)	X5LL-5236-NSNT	2937.25	3256.00	3468.68	3727.23	3028.05	3346.80	3559.48	3818.03
	42"(1067mm)	14"(356mm)	X5LL-5242-NSNT	3136.65	3466.90	3687.26	3956.26	3239.33	3569.58	3789.94	4058.94
	48"(1219mm)	14"(356mm)	X5LL-5248-NSNT	3319.66	3661.41	3889.45	4168.90	3434.22	3775.97	4004.01	4283.46
	54"(1372mm)	14"(356mm)	X5LL-5254-NSNT	3502.67	3855.92	4091.64	4381.54	3629.11	3982.36	4218.08	4507.98
	60"(1524mm)	14"(356mm)	X5LL-5260-NSNT	3685.68	4050.43	4293.83	4594.18	3824.00	4188.75	4432.15	4732.50
	66"(1676mm)	14"(356mm)	X5LL-5266-NSNT	3868.69	4244.94	4496.02	4806.82	4018.89	4395.14	4646.22	4957.02
	72"(1829mm)	14"(356mm)	X5LL-5272-NSNT	4051.70	4439.45	4698.21	5019.46	4213.78	4601.53	4860.29	5181.54
	78"(1981mm)	14"(356mm)	X5LL-5278-NSNT	4251.10	4650.35	4916.79	5248.49	4425.06	4824.31	5090.75	5422.45
	84"(2134mm)	14"(356mm)	X5LL-5284-NSNT	4434.11	4844.86	5118.98	5461.13	4619.95	5030.70	5304.82	5646.97
	90"(2286mm)	14"(356mm)	X5LL-5290-NSNT	4617.12	5039.37	5321.17	5673.77	4814.84	5237.09	5518.89	5871.49
	96"(2438mm)	14"(356mm)	X5LL-5296-NSNT	4800.13	5233.88	5523.36	5886.41	5009.73	5443.48	5732.96	6096.01
<b>Legal Depth</b>											
52.5"(1334mm)	30"(762mm)	16.5"(419mm)	X5LD-5230-NSNT	\$2903.17	\$3210.42	\$3415.42	\$3663.52	\$2994.00	\$3301.25	\$3506.25	\$3754.35
	36"(914mm)	16.5"(419mm)	X5LD-5236-NSNT	3086.18	3404.93	3617.61	3876.16	3188.89	3507.64	3720.32	3978.87
	42"(1067mm)	16.5"(419mm)	X5LD-5242-NSNT	3285.58	3615.83	3836.19	4105.19	3400.17	3730.42	3950.78	4219.78
	48"(1219mm)	16.5"(419mm)	X5LD-5248-NSNT	3468.59	3810.34	4038.38	4317.83	3595.06	3936.81	4164.85	4444.30
	54"(1372mm)	16.5"(419mm)	X5LD-5254-NSNT	3651.60	4004.85	4240.57	4530.47	3789.95	4143.20	4378.92	4668.82
	60"(1524mm)	16.5"(419mm)	X5LD-5260-NSNT	3834.61	4199.36	4442.76	4743.11	3984.84	4349.59	4592.99	4893.34
	66"(1676mm)	16.5"(419mm)	X5LD-5266-NSNT	4017.62	4393.87	4644.95	4955.75	4179.73	4555.98	4807.06	5117.86
	72"(1829mm)	16.5"(419mm)	X5LD-5272-NSNT	4200.63	4588.38	4847.14	5168.39	4374.62	4762.37	5021.13	5342.38
	78"(1981mm)	16.5"(419mm)	X5LD-5278-NSNT	4400.03	4799.28	5065.72	5397.42	4585.90	4985.15	5251.59	5583.29
	84"(2134mm)	16.5"(419mm)	X5LD-5284-NSNT	4583.04	4993.79	5267.91	5610.06	4780.79	5191.54	5465.66	5807.81
	90"(2286mm)	16.5"(419mm)	X5LD-5290-NSNT	4766.05	5188.30	5470.10	5822.70	4975.68	5397.93	5679.73	6032.33
	96"(2438mm)	16.5"(419mm)	X5LD-5296-NSNT	4949.06	5382.81	5672.29	6035.34	5170.57	5604.32	5893.80	6256.85

Height	Width	Depth	Number	Wood Group A Glass				Wood Group B Glass			
				A	C	D	F	A	C	D	F
<b>Letter Depth</b>											
52.5"(1334mm)	30"(762mm)	14"(356mm)	X4LL-5230-NSNT	\$3476.61	\$3783.86	\$3988.86	\$4236.96	\$3644.90	\$3952.15	\$4157.15	\$4405.25
	36"(914mm)	14"(356mm)	X4LL-5236-NSNT	3737.05	4055.80	4268.48	4527.03	3924.33	4243.08	4455.76	4714.31
	42"(1067mm)	14"(356mm)	X4LL-5242-NSNT	4013.88	4344.13	4564.49	4833.49	4220.15	4550.40	4770.76	5039.76
	48"(1219mm)	14"(356mm)	X4LL-5248-NSNT	4274.32	4616.07	4844.11	5123.56	4499.58	4841.33	5069.37	5348.82
	54"(1372mm)	14"(356mm)	X4LL-5254-NSNT	4534.76	4888.01	5123.73	5413.63	4779.01	5132.26	5367.98	5657.88
	60"(1524mm)	14"(356mm)	X4LL-5260-NSNT	4795.20	5159.95	5403.35	5703.70	5058.44	5423.19	5666.59	5966.94
	66"(1676mm)	14"(356mm)	X4LL-5266-NSNT	5055.64	5431.89	5682.97	5993.77	5337.87	5714.12	5965.20	6276.00
	72"(1829mm)	14"(356mm)	X4LL-5272-NSNT	5316.08	5703.83	5962.59	6283.84	5617.30	6005.05	6263.81	6585.06
	78"(1981mm)	14"(356mm)	X4LL-5278-NSNT	5592.91	5992.16	6258.60	6590.30	5913.12	6312.37	6578.81	6910.51
	84"(2134mm)	14"(356mm)	X4LL-5284-NSNT	5853.35	6264.10	6538.22	6880.37	6192.55	6603.30	6877.42	7219.57
	90"(2286mm)	14"(356mm)	X4LL-5290-NSNT	6113.79	6536.04	6817.84	7170.44	6471.98	6894.23	7176.03	7528.63
	96"(2438mm)	14"(356mm)	X4LL-5296-NSNT	6374.23	6807.98	7097.46	7460.51	6751.41	7185.16	7474.64	7837.69
<b>Legal Depth</b>											
52.5"(1334mm)	30"(762mm)	16.5"(419mm)	X4LD-5230-NSNT	\$3677.69	\$3984.94	\$4189.94	\$4438.04	\$3866.05	\$4173.30	\$4378.30	\$4626.40
	36"(914mm)	16.5"(419mm)	X4LD-5236-NSNT	3938.13	4256.88	4469.56	4728.11	4145.48	4464.23	4676.91	4935.46
	42"(1067mm)	16.5"(419mm)	X4LD-5242-NSNT	4214.96	4545.21	4765.57	5034.57	4441.30	4771.55	4991.91	5260.91
	48"(1219mm)	16.5"(419mm)	X4LD-5248-NSNT	4475.40	4817.15	5045.19	5324.64	4720.73	5062.48	5290.52	5569.97
	54"(1372mm)	16.5"(419mm)	X4LD-5254-NSNT	4735.84	5089.09	5324.81	5614.71	5000.16	5353.41	5589.13	5879.03
	60"(1524mm)	16.5"(419mm)	X4LD-5260-NSNT	4996.28	5361.03	5604.43	5904.78	5279.59	5644.34	5887.74	6188.09
	66"(1676mm)	16.5"(419mm)	X4LD-5266-NSNT	5256.72	5632.97	5884.05	6194.85	5559.02	5935.27	6186.35	6497.15
	72"(1829mm)	16.5"(419mm)	X4LD-5272-NSNT	5517.16	5904.91	6163.67	6484.92	5838.45	6226.20	6484.96	6806.21
	78"(1981mm)	16.5"(419mm)	X4LD-5278-NSNT	5793.99	6193.24	6459.68	6791.38	6134.27	6533.52	6799.96	7131.66
	84"(2134mm)	16.5"(419mm)	X4LD-5284-NSNT	6054.43	6465.18	6739.30	7081.45	6413.70	6824.45	7098.57	7440.72
	90"(2286mm)	16.5"(419mm)	X4LD-5290-NSNT	6314.87	6737.12	7018.92	7371.52	6693.13	7115.38	7397.18	7749.78
	96"(2438mm)	16.5"(419mm)	X4LD-5296-NSNT	6575.31	7009.06	7298.54	7661.59	6972.56	7406.31	7695.79	8058.84

# Masters Series

## Tackboards for Vertical Storage Units

	Height	Width	Number	Fabric Grade		
				A	B	C
<b>Tackboards — Vertical Storage Units — Fabric</b>	24"(610mm)	27.5"(699mm)	MTVD-2430	\$372.07	\$ 415.77	\$ 465.11
		33.5"(851mm)	MTVD-2436	397.30	444.80	498.39
		39.5"(1003mm)	MTVD-2442	422.53	473.83	531.67
		45.5"(1156mm)	MTVD-2448	447.76	502.86	564.95
		51.5"(1308mm)	MTVD-2454	472.99	531.89	598.23
		57.5"(1461mm)	MTVD-2460	498.22	560.92	631.51
		63.5"(1613mm)	MTVD-2466	636.85	732.45	840.47
		69.5"(1765mm)	MTVD-2472	694.50	798.75	916.55
		75.5"(1918mm)	MTVD-2478	752.15	865.05	992.63
		81.5"(2070mm)	MTVD-2484	809.80	931.35	1068.71
		87.5"(2223mm)	MTVD-2490	867.45	997.65	1144.79
		93.5"(2375mm)	MTVD-2496	925.10	1063.95	1220.87

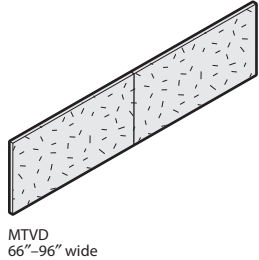
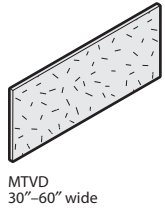

**Feature**

- Tackboards over 60"(1524mm) wide include two fabric sections.

**Specification Tips**

- Designed to mount on lower back panel of vertical storage unit.
- Tackboard widths are nominal; Catalog Number indicates width of Vertical Storage Unit for which the tackboard is to be used.

**To Order, Specify:**

- 1) Product number.
- 2) Fabric code.

	Height	Width	Number	Fabric Grade		
				A	B	C
<b>Tackboards — Vertical Storage Units — Fabric and Slat Rail</b>	24"(610mm)	27.5"(699mm)	MTSV-2430	\$ 594.39	\$ 612.98	\$ 625.34
		33.5"(851mm)	MTSV-2436	633.16	652.79	666.01
		39.5"(1003mm)	MTSV-2442	671.93	692.60	706.68
		45.5"(1156mm)	MTSV-2448	710.70	732.41	747.35
		51.5"(1308mm)	MTSV-2454	749.47	772.22	788.02
		57.5"(1461mm)	MTSV-2460	788.24	812.03	828.69
		63.5"(1613mm)	MTSV-2466	903.07	933.07	955.62
		69.5"(1765mm)	MTSV-2472	977.11	1009.56	1033.84
		75.5"(1918mm)	MTSV-2478	1051.15	1086.05	1112.06
		81.5"(2070mm)	MTSV-2484	1125.19	1162.54	1190.28
		87.5"(2223mm)	MTSV-2490	1199.23	1239.03	1268.50
		93.5"(2375mm)	MTSV-2496	1261.75	1324.33	1374.72

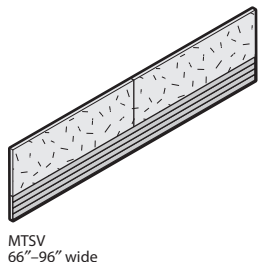
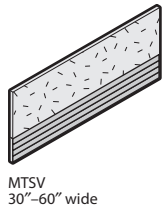

**Features**

- Includes fabric covered tackboard(s) with slat rail.
- Tackboards over 60"(1524mm) wide include two fabric sections.
- Optional slat rail is one full-width section.

**Specification Tips**

- Designed to mount on lower back panel of vertical storage unit.
- Slat rail accommodates separately specified Belong work tools.
- Tackboard widths are nominal; Catalog Number indicates width of Vertical Storage Unit for which the tackboard is to be used.

**To Order, Specify:**

- 1) Product number.
- 2) Fabric code.
- 3) Trim code for slat rail.

This page intentionally blank

# Masters Series

## Open Sided Shelf

### 1H and 2H

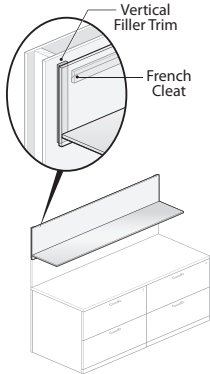

ULWL-1730-NSN  
ULWD-1730-NSN

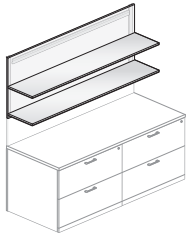

ULWL-2930-NSN  
ULWD-2930-NSN

### Features

- Includes shelf with back panel with vertical filler trim attached on each side, 4"(102mm)H French cleat with anti-dislodgement feature and attachment hardware.
- Available in Laminate or Wood.
- Laminate shelf available from 30"(762mm) to 120"(3048mm) wide.
- Wood shelf available from 30"(762mm) to 96"(2438mm)wide.
- Shelf available in letter and legal depth.
- 1H has one fixed shelf.
- 2H has two fixed shelves.
- Ships unassembled.

### Specification Tips

- Must be properly anchored to a structural wall.
- Anchors are not provided, must be field supplied.
- Product application options for adjacent 1H and 2H upper storage components; Open Sided Shelf and Overhead Storage:
  - 1H adjacent to 1H - installed 69"(1753mm) above finished floor to the top of upper storage.
  - 2H adjacent to 2H - installed 81.625"(2073mm) above finished floor to the top of upper storage.
  - 1H adjacent to 2H - 1H upper storage component to be installed 69"(1753mm) above finished floor to the top of upper storage for horizontal alignment between adjacent 1H and 2H upper storage components. **If a 1H upper storage component is needed to align with the top of a 2H upper storage component contact Tailored Solutions.**
- Commonly used above a separately specified tackboard.
- If a tackboard is required between 1.5H lower storage and 1.5H or 2H upper storage contact Tailored Solutions; tackboard height is not available as standard product.
- An Open Sided Shelf does not have a front valance and is not recommended for use with a task light; if specified the task light will be visible.
- To achieve proper alignment when installing Open Sided Shelves side by side, installation must be performed using eparts tool #TS00-137Z and field supplied dowels.315" (8mm) X 1.25" (31.75mm).

### To Order, Specify:

#### Laminate Surface:

- 1) Product number.
- 2) Laminate surface color.
- 3) Edge trim color.

#### Wood Surface:

- 1) Product number.
- 2) Wood finish for surface/edge.

**Masters Series**

Open Sided Shelf

Nominal Height	Nominal Depth	Nominal Width	Laminate Number	Laminate A	B	Wood Number	Wood Group A	Wood Group B
<b>1H — Letter Depth</b>								
17"(432mm)	14"(356mm)	30"(762mm)	ULWL-1730-NSN	\$1095.92	\$1157.77	UXWL-1730-NSN	\$1516.59	\$1541.80
		36"(914mm)	ULWL-1736-NSN	1176.21	1244.48	UXWL-1736-NSN	1631.99	1664.14
		42"(1067mm)	ULWL-1742-NSN	1256.50	1331.19	UXWL-1742-NSN	1747.39	1786.48
		48"(1219mm)	ULWL-1748-NSN	1336.79	1417.90	UXWL-1748-NSN	1862.79	1908.82
		54"(1372mm)	ULWL-1754-NSN	1417.08	1504.61	UXWL-1754-NSN	1978.19	2031.16
		60"(1524mm)	ULWL-1760-NSN	1497.37	1591.32	UXWL-1760-NSN	2093.59	2153.50
		66"(1676mm)	ULWL-1766-NSN	1577.66	1678.03	UXWL-1766-NSN	2208.99	2275.84
		72"(1829mm)	ULWL-1772-NSN	1657.95	1764.74	UXWL-1772-NSN	2324.39	2398.18
		78"(1981mm)	ULWL-1778-NSN	1738.24	1851.45	UXWL-1778-NSN	2439.79	2520.52
		84"(2134mm)	ULWL-1784-NSN	1818.53	1938.16	UXWL-1784-NSN	2555.19	2642.86
		90"(2286mm)	ULWL-1790-NSN	1898.82	2024.87	UXWL-1790-NSN	2670.59	2765.20
		96"(2438mm)	ULWL-1796-NSN	1979.11	2111.58	UXWL-1796-NSN	2785.99	2887.54
		102"(2591mm)	ULWL-17A2-NSN	2059.40	2198.29	UXWL-17A2-NSN	N/A	N/A
		108"(2743mm)	ULWL-17A8-NSN	2139.69	2285.00	UXWL-17A8-NSN	N/A	N/A
		114"(2896mm)	ULWL-17B4-NSN	2219.98	2371.71	UXWL-17B4-NSN	N/A	N/A
		120"(3048mm)	ULWL-17C0-NSN	2300.27	2458.42	UXWL-17C0-NSN	N/A	N/A
<b>1H — Legal Depth</b>								
	16.5"(419mm)	30"(762mm)	ULWD-1730-NSN	\$1114.22	\$1177.52	UXWD-1730-NSN	\$1555.34	\$1582.90
		36"(914mm)	ULWD-1736-NSN	1194.51	1264.23	UXWD-1736-NSN	1670.74	1705.24
		42"(1067mm)	ULWD-1742-NSN	1274.80	1350.94	UXWD-1742-NSN	1786.14	1827.58
		48"(1219mm)	ULWD-1748-NSN	1355.09	1437.65	UXWD-1748-NSN	1901.54	1949.92
		54"(1372mm)	ULWD-1754-NSN	1435.38	1524.36	UXWD-1754-NSN	2016.94	2072.26
		60"(1524mm)	ULWD-1760-NSN	1515.67	1611.07	UXWD-1760-NSN	2132.34	2194.60
		66"(1676mm)	ULWD-1766-NSN	1595.96	1697.78	UXWD-1766-NSN	2247.74	2316.94
		72"(1829mm)	ULWD-1772-NSN	1676.25	1784.49	UXWD-1772-NSN	2363.14	2439.28
		78"(1981mm)	ULWD-1778-NSN	1756.54	1871.20	UXWD-1778-NSN	2478.54	2561.62
		84"(2134mm)	ULWD-1784-NSN	1836.83	1957.91	UXWD-1784-NSN	2593.94	2683.96
		90"(2286mm)	ULWD-1790-NSN	1917.12	2044.62	UXWD-1790-NSN	2709.34	2806.30
		96"(2438mm)	ULWD-1796-NSN	1997.41	2131.33	UXWD-1796-NSN	2824.74	2928.64
		102"(2591mm)	ULWD-17A2-NSN	2077.70	2218.04	UXWD-17A2-NSN	N/A	N/A
		108"(2743mm)	ULWD-17A8-NSN	2157.99	2304.75	UXWD-17A8-NSN	N/A	N/A
		114"(2896mm)	ULWD-17B4-NSN	2238.28	2391.46	UXWD-17B4-NSN	N/A	N/A
		120"(3048mm)	ULWD-17C0-NSN	2318.57	2478.17	UXWD-17C0-NSN	N/A	N/A
<b>2H — Letter Depth</b>								
29"(737mm)	14"(356mm)	30"(762mm)	ULWL-2930-NSN	\$1159.75	\$1226.80	UXWL-2930-NSN	\$1618.38	\$1649.70
		36"(914mm)	ULWL-2936-NSN	1240.04	1313.51	UXWL-2936-NSN	1733.78	1772.04
		42"(1067mm)	ULWL-2942-NSN	1320.33	1400.22	UXWL-2942-NSN	1849.18	1894.38
		48"(1219mm)	ULWL-2948-NSN	1400.62	1486.93	UXWL-2948-NSN	1964.58	2016.72
		54"(1372mm)	ULWL-2954-NSN	1480.91	1573.64	UXWL-2954-NSN	2079.98	2139.06
		60"(1524mm)	ULWL-2960-NSN	1561.20	1660.35	UXWL-2960-NSN	2195.38	2261.40
		66"(1676mm)	ULWL-2966-NSN	1641.49	1747.06	UXWL-2966-NSN	2310.78	2383.74
		72"(1829mm)	ULWL-2972-NSN	1721.78	1833.77	UXWL-2972-NSN	2426.18	2506.08
		78"(1981mm)	ULWL-2978-NSN	1802.07	1920.48	UXWL-2978-NSN	2541.58	2628.42
		84"(2134mm)	ULWL-2984-NSN	1882.36	2007.19	UXWL-2984-NSN	2656.98	2750.76
		90"(2286mm)	ULWL-2990-NSN	1962.65	2093.90	UXWL-2990-NSN	2772.38	2873.10
		96"(2438mm)	ULWL-2996-NSN	2042.94	2180.61	UXWL-2996-NSN	2887.78	2995.44
		102"(2591mm)	ULWL-29A2-NSN	2123.23	2267.32	UXWL-29A2-NSN	N/A	N/A
		108"(2743mm)	ULWL-29A8-NSN	2203.52	2354.03	UXWL-29A8-NSN	N/A	N/A
		114"(2896mm)	ULWL-29B4-NSN	2283.81	2440.74	UXWL-29B4-NSN	N/A	N/A
		120"(3048mm)	ULWL-29C0-NSN	2364.10	2527.45	UXWL-29C0-NSN	N/A	N/A
<b>2H — Legal Depth</b>								
	16.5"(419mm)	30"(762mm)	ULWD-2930-NSN	\$1178.05	\$1246.55	UXWD-2930-NSN	\$1657.13	\$1690.80
		36"(914mm)	ULWD-2936-NSN	1258.34	1333.26	UXWD-2936-NSN	1772.53	1813.14
		42"(1067mm)	ULWD-2942-NSN	1338.63	1419.97	UXWD-2942-NSN	1887.93	1935.48
		48"(1219mm)	ULWD-2948-NSN	1418.92	1506.68	UXWD-2948-NSN	2003.33	2057.82
		54"(1372mm)	ULWD-2954-NSN	1499.21	1593.39	UXWD-2954-NSN	2118.73	2180.16
		60"(1524mm)	ULWD-2960-NSN	1579.50	1680.10	UXWD-2960-NSN	2234.13	2302.50
		66"(1676mm)	ULWD-2966-NSN	1659.79	1766.81	UXWD-2966-NSN	2349.53	2424.84
		72"(1829mm)	ULWD-2972-NSN	1740.08	1853.52	UXWD-2972-NSN	2464.93	2547.18
		78"(1981mm)	ULWD-2978-NSN	1820.37	1940.23	UXWD-2978-NSN	2580.33	2669.52
		84"(2134mm)	ULWD-2984-NSN	1900.66	2026.94	UXWD-2984-NSN	2695.73	2791.86
		90"(2286mm)	ULWD-2990-NSN	1980.95	2113.65	UXWD-2990-NSN	2811.13	2914.20
		96"(2438mm)	ULWD-2996-NSN	2061.24	2200.36	UXWD-2996-NSN	2926.53	3036.54
		102"(2591mm)	ULWD-29A2-NSN	2141.53	2287.07	UXWD-29A2-NSN	N/A	N/A
		108"(2743mm)	ULWD-29A8-NSN	2221.82	2373.78	UXWD-29A8-NSN	N/A	N/A
		114"(2896mm)	ULWD-29B4-NSN	2302.11	2460.49	UXWD-29B4-NSN	N/A	N/A
		120"(3048mm)	ULWD-29C0-NSN	2382.40	2547.20	UXWD-29C0-NSN	N/A	N/A

# Masters Series

## Overhead Storage Units Open

### Overhead Storage Units — 1H Open

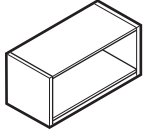

30" and 36" widths

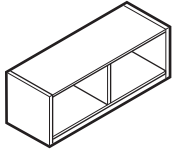

42", 48" and 54" widths

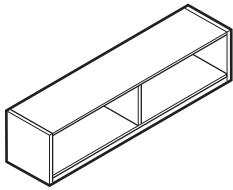

60", 66" and 72" widths

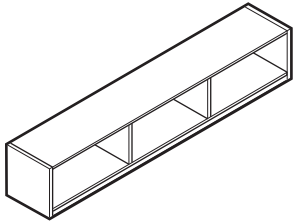

78", 84", 90" and 96" widths  
ULNL-SN  
ULND-SN  
UXNL-SN  
UXND-SN

### Features

- Includes storage cabinet(s) with 2"(51mm) integrated light valance and 4"(102mm) French cleat with anti-dislodgement feature.
- Shipped assembled.

### Specification Tips

- Accommodates separately specified tackboards and lighting accessories.
- Must be properly anchored to a structural wall.
- Anchors are not provided, must be field supplied.

### To Order, Specify:

- 1) Product number.
- 2) Finish code (laminated or wood).
- 3) Laminate edge trim color (if laminate specified).

# Masters Series

Overhead Storage Units Open

Height	Width	Depth	Number	Laminate	
				A	B
<b>Laminate — Letter Depth</b>					
16.56"(421mm)	30"(762mm)	14"(356mm)	ULNL-1730-NSN	\$1072.38	\$1131.95
	36"(914mm)	14"(356mm)	ULNL-1736-NSN	1184.08	1252.58
	42"(1067mm)	14"(356mm)	ULNL-1742-NSN	1312.17	1389.60
	48"(1219mm)	14"(356mm)	ULNL-1748-NSN	1423.87	1510.23
	54"(1372mm)	14"(356mm)	ULNL-1754-NSN	1535.57	1630.86
	60"(1524mm)	14"(356mm)	ULNL-1760-NSN	1647.27	1751.49
	66"(1676mm)	14"(356mm)	ULNL-1766-NSN	1758.97	1872.12
	72"(1829mm)	14"(356mm)	ULNL-1772-NSN	1870.67	1992.75
	78"(1981mm)	14"(356mm)	ULNL-1778-NSN	1998.76	2129.77
	84"(2134mm)	14"(356mm)	ULNL-1784-NSN	2110.46	2250.40
	90"(2286mm)	14"(356mm)	ULNL-1790-NSN	2222.16	2371.03
	96"(2438mm)	14"(356mm)	ULNL-1796-NSN	2333.86	2491.66

<b>Laminate — Legal Depth</b>					
16.56"(421mm)	30"(762mm)	16.5"(419mm)	ULND-1730-NSN	\$1221.31	\$1292.79
	36"(914mm)	16.5"(419mm)	ULND-1736-NSN	1333.01	1413.42
	42"(1067mm)	16.5"(419mm)	ULND-1742-NSN	1461.10	1550.44
	48"(1219mm)	16.5"(419mm)	ULND-1748-NSN	1572.80	1671.07
	54"(1372mm)	16.5"(419mm)	ULND-1754-NSN	1684.50	1791.70
	60"(1524mm)	16.5"(419mm)	ULND-1760-NSN	1796.20	1912.33
	66"(1676mm)	16.5"(419mm)	ULND-1766-NSN	1907.90	2032.96
	72"(1829mm)	16.5"(419mm)	ULND-1772-NSN	2019.60	2153.59
	78"(1981mm)	16.5"(419mm)	ULND-1778-NSN	2147.69	2290.61
	84"(2134mm)	16.5"(419mm)	ULND-1784-NSN	2259.39	2411.24
	90"(2286mm)	16.5"(419mm)	ULND-1790-NSN	2371.09	2531.87
	96"(2438mm)	16.5"(419mm)	ULND-1796-NSN	2482.79	2652.50

Height	Width	Depth	Number	Wood	
				Group A	Group B
<b>Wood — Letter Depth</b>					
16.56"(421mm)	30"(762mm)	14"(356mm)	UXNL-1730-NSN	\$1806.48	\$2012.04
	36"(914mm)	14"(356mm)	UXNL-1736-NSN	2013.04	2239.24
	42"(1067mm)	14"(356mm)	UXNL-1742-NSN	2235.99	2482.83
	48"(1219mm)	14"(356mm)	UXNL-1748-NSN	2442.55	2710.03
	54"(1372mm)	14"(356mm)	UXNL-1754-NSN	2649.11	2937.23
	60"(1524mm)	14"(356mm)	UXNL-1760-NSN	2855.67	3164.43
	66"(1676mm)	14"(356mm)	UXNL-1766-NSN	3062.23	3391.63
	72"(1829mm)	14"(356mm)	UXNL-1772-NSN	3268.79	3618.83
	78"(1981mm)	14"(356mm)	UXNL-1778-NSN	3491.74	3862.42
	84"(2134mm)	14"(356mm)	UXNL-1784-NSN	3698.30	4089.62
	90"(2286mm)	14"(356mm)	UXNL-1790-NSN	3904.86	4316.82
	96"(2438mm)	14"(356mm)	UXNL-1796-NSN	4111.42	4544.02

<b>Wood — Legal Depth</b>					
16.56"(421mm)	30"(762mm)	16.5"(419mm)	UXND-1730-NSN	\$2048.95	\$2278.75
	36"(914mm)	16.5"(419mm)	UXND-1736-NSN	2255.51	2505.95
	42"(1067mm)	16.5"(419mm)	UXND-1742-NSN	2478.46	2749.54
	48"(1219mm)	16.5"(419mm)	UXND-1748-NSN	2685.02	2976.74
	54"(1372mm)	16.5"(419mm)	UXND-1754-NSN	2891.58	3203.94
	60"(1524mm)	16.5"(419mm)	UXND-1760-NSN	3098.14	3431.14
	66"(1676mm)	16.5"(419mm)	UXND-1766-NSN	3304.70	3658.34
	72"(1829mm)	16.5"(419mm)	UXND-1772-NSN	3511.26	3885.54
	78"(1981mm)	16.5"(419mm)	UXND-1778-NSN	3734.21	4129.13
	84"(2134mm)	16.5"(419mm)	UXND-1784-NSN	3940.77	4356.33
	90"(2286mm)	16.5"(419mm)	UXND-1790-NSN	4147.33	4583.53
	96"(2438mm)	16.5"(419mm)	UXND-1796-NSN	4353.89	4810.73

# Masters Series

## Overhead Storage Units Open

### Overhead Storage Units — 2H Open

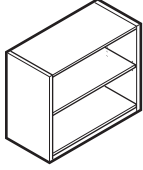

30" and 36" widths

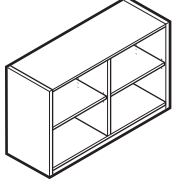

42", 48" and 54" widths

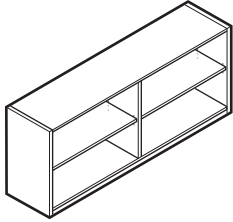

60", 66" and 72" widths

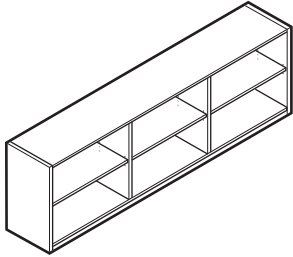

78", 84", 90" and 96" widths

ULNL-SN  
ULND-SN  
UXNL-SN  
UXND-SN

### Features

- Includes storage cabinet(s) with 2"(51mm) integrated light valance, one adjustable shelf and 4"(102mm) French cleat with anti-dislodgement feature.
- Shipped assembled.

### Specification Tips

- Accommodates separately specified tackboards and lighting accessories.
- Must be properly anchored to a structural wall.
- Anchors are not provided, must be field supplied.

### To Order, Specify:

- 1) Product number.
- 2) Finish code (laminated or wood).
- 3) Laminate edge trim color (if laminate specified).



# Masters Series

Overhead Storage Units Open

Height	Width	Depth	Number	Laminate	
				A	B
<b>Laminate — Letter Depth</b>					
29.125"(740mm)	30"(762mm)	14"(356mm)	ULNL-2930-NSN	\$1305.66	\$1383.83
	36"(914mm)	14"(356mm)	ULNL-2936-NSN	1451.64	1541.69
	42"(1067mm)	14"(356mm)	ULNL-2942-NSN	1614.01	1715.94
	48"(1219mm)	14"(356mm)	ULNL-2948-NSN	1759.99	1873.80
	54"(1372mm)	14"(356mm)	ULNL-2954-NSN	1905.97	2031.66
	60"(1524mm)	14"(356mm)	ULNL-2960-NSN	2051.95	2189.52
	66"(1676mm)	14"(356mm)	ULNL-2966-NSN	2197.93	2347.38
	72"(1829mm)	14"(356mm)	ULNL-2972-NSN	2343.91	2505.24
	78"(1981mm)	14"(356mm)	ULNL-2978-NSN	2506.28	2679.49
	84"(2134mm)	14"(356mm)	ULNL-2984-NSN	2652.26	2837.35
	90"(2286mm)	14"(356mm)	ULNL-2990-NSN	2798.24	2995.21
	96"(2438mm)	14"(356mm)	ULNL-2996-NSN	2944.22	3153.07

<b>Laminate — Legal Depth</b>					
29.125"(740mm)	30"(762mm)	16.5"(419mm)	ULND-2930-NSN	\$1454.59	\$1544.67
	36"(914mm)	16.5"(419mm)	ULND-2936-NSN	1600.57	1702.53
	42"(1067mm)	16.5"(419mm)	ULND-2942-NSN	1762.94	1876.78
	48"(1219mm)	16.5"(419mm)	ULND-2948-NSN	1908.92	2034.64
	54"(1372mm)	16.5"(419mm)	ULND-2954-NSN	2054.90	2192.50
	60"(1524mm)	16.5"(419mm)	ULND-2960-NSN	2200.88	2350.36
	66"(1676mm)	16.5"(419mm)	ULND-2966-NSN	2346.86	2508.22
	72"(1829mm)	16.5"(419mm)	ULND-2972-NSN	2492.84	2666.08
	78"(1981mm)	16.5"(419mm)	ULND-2978-NSN	2655.21	2840.33
	84"(2134mm)	16.5"(419mm)	ULND-2984-NSN	2801.19	2998.19
	90"(2286mm)	16.5"(419mm)	ULND-2990-NSN	2947.17	3156.05
	96"(2438mm)	16.5"(419mm)	ULND-2996-NSN	3093.15	3313.91

Height	Width	Depth	Number	Wood	
				Group A	Group B
<b>Wood — Letter Depth</b>					
29.125"(740mm)	30"(762mm)	14"(356mm)	UXNL-2930-NSN	\$2233.20	\$2481.12
	36"(914mm)	14"(356mm)	UXNL-2936-NSN	2502.62	2777.48
	42"(1067mm)	14"(356mm)	UXNL-2942-NSN	2788.43	3090.23
	48"(1219mm)	14"(356mm)	UXNL-2948-NSN	3057.85	3386.59
	54"(1372mm)	14"(356mm)	UXNL-2954-NSN	3327.27	3682.95
	60"(1524mm)	14"(356mm)	UXNL-2960-NSN	3596.69	3979.31
	66"(1676mm)	14"(356mm)	UXNL-2966-NSN	3866.11	4275.67
	72"(1829mm)	14"(356mm)	UXNL-2972-NSN	4135.53	4572.03
	78"(1981mm)	14"(356mm)	UXNL-2978-NSN	4421.34	4884.78
	84"(2134mm)	14"(356mm)	UXNL-2984-NSN	4690.76	5181.14
	90"(2286mm)	14"(356mm)	UXNL-2990-NSN	4960.18	5477.50
	96"(2438mm)	14"(356mm)	UXNL-2996-NSN	5229.60	5773.86

<b>Wood — Legal Depth</b>					
29.125"(740mm)	30"(762mm)	16.5"(419mm)	UXND-2930-NSN	\$2475.67	\$2747.83
	36"(914mm)	16.5"(419mm)	UXND-2936-NSN	2745.09	3044.19
	42"(1067mm)	16.5"(419mm)	UXND-2942-NSN	3030.90	3356.94
	48"(1219mm)	16.5"(419mm)	UXND-2948-NSN	3300.32	3653.30
	54"(1372mm)	16.5"(419mm)	UXND-2954-NSN	3569.74	3949.66
	60"(1524mm)	16.5"(419mm)	UXND-2960-NSN	3839.16	4246.02
	66"(1676mm)	16.5"(419mm)	UXND-2966-NSN	4108.58	4542.38
	72"(1829mm)	16.5"(419mm)	UXND-2972-NSN	4378.00	4838.74
	78"(1981mm)	16.5"(419mm)	UXND-2978-NSN	4663.81	5151.49
	84"(2134mm)	16.5"(419mm)	UXND-2984-NSN	4933.23	5447.85
	90"(2286mm)	16.5"(419mm)	UXND-2990-NSN	5202.65	5744.21
	96"(2438mm)	16.5"(419mm)	UXND-2996-NSN	5472.07	6040.57

# Masters Series

## Overhead Storage Units with Hinged Doors

### Overhead Storage Units — 1H with Hinged Doors

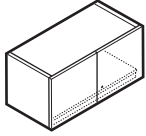

ULOL-SN  
ULOD-SN  
UXOL-SN  
UXOD-SN  
30" and 36" widths

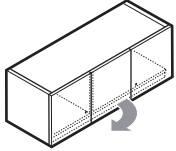

ULOL-SL  
ULOD-SL  
UXOL-SL  
UXOD-SL  
42", 48" and 54" widths  
(Left-hand single door swing shown)

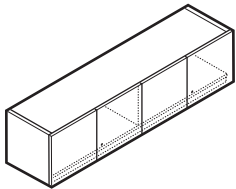

ULOL-SN  
ULOD-SN  
UXOL-SN  
UXOD-SN  
60", 66" and 72" widths

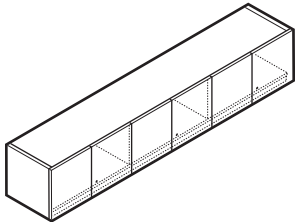

ULOL-SN  
ULOD-SN  
UXOL-SN  
UXOD-SN  
78", 84", 90" and 96" widths

### Features

- Includes storage cabinet(s) with hinged doors, 2"(51mm) integrated light valance and 4"(102mm) French cleat with anti-dislodgement feature.
- 42"(1067mm), 48"(1219mm) and 54"(1372mm) wide units available with choice of left or right door swing for single door.
- Common keys within each unit.
- Lock plug is available in black or chrome.
- For lock options, refer to Lock Program section of the Accessories Price List.
- Shipped assembled.

### Specification Tips

- Accommodates separately specified tackboards and lighting accessories.
- Must be properly anchored to a structural wall.
- Anchors are not provided, must be field supplied.

### To Order, Specify:

- 1) Product number.

#### ① Lock Option:

- N** No Lock
- L** Lock  
30"-36", add **\$169.05** list  
42"-72", add **\$338.10** list  
78"-96", add **\$507.16** list

#### ② Single Door Swing Orientation:

(42", 48" and 54" wide only)

- L** Left-hand
- R** Right-hand

- 2) Finish code (laminate or wood).
- 3) Laminate edge trim color (if laminate specified).
- 4) Trim color for lock (if specified).

**Masters Series**

Overhead Storage Units with Hinged Doors

Height	Width	Depth	Number ① ②	Laminate	
				A	B
<b>Laminate — Letter Depth</b>					
16.56"(421mm)	30"(762mm)	14"(356mm)	ULOL-1730- SN	\$1437.28	\$1526.05
	36"(914mm)	14"(356mm)	ULOL-1736- SN	1566.42	1665.59
	42"(1067mm)	14"(356mm)	ULOL-1742- S	1711.95	1821.52
	48"(1219mm)	14"(356mm)	ULOL-1748- S	1841.09	1961.06
	54"(1372mm)	14"(356mm)	ULOL-1754- S	1970.23	2100.60
	60"(1524mm)	14"(356mm)	ULOL-1760- SN	2099.37	2240.14
	66"(1676mm)	14"(356mm)	ULOL-1766- SN	2228.51	2379.68
	72"(1829mm)	14"(356mm)	ULOL-1772- SN	2357.65	2519.22
	78"(1981mm)	14"(356mm)	ULOL-1778- SN	2503.18	2675.15
	84"(2134mm)	14"(356mm)	ULOL-1784- SN	2632.32	2814.69
	90"(2286mm)	14"(356mm)	ULOL-1790- SN	2761.46	2954.23
	96"(2438mm)	14"(356mm)	ULOL-1796- SN	2890.60	3093.77
<b>Laminate — Legal Depth</b>					
16.56"(421mm)	30"(762mm)	16.5"(419mm)	ULOD-1730- SN	\$1586.21	\$1686.89
	36"(914mm)	16.5"(419mm)	ULOD-1736- SN	1715.35	1826.43
	42"(1067mm)	16.5"(419mm)	ULOD-1742- S	1860.88	1982.36
	48"(1219mm)	16.5"(419mm)	ULOD-1748- S	1990.02	2121.90
	54"(1372mm)	16.5"(419mm)	ULOD-1754- S	2119.16	2261.44
	60"(1524mm)	16.5"(419mm)	ULOD-1760- SN	2248.30	2400.98
	66"(1676mm)	16.5"(419mm)	ULOD-1766- SN	2377.44	2540.52
	72"(1829mm)	16.5"(419mm)	ULOD-1772- SN	2506.58	2680.06
	78"(1981mm)	16.5"(419mm)	ULOD-1778- SN	2652.11	2835.99
	84"(2134mm)	16.5"(419mm)	ULOD-1784- SN	2781.25	2975.53
	90"(2286mm)	16.5"(419mm)	ULOD-1790- SN	2910.39	3115.07
	96"(2438mm)	16.5"(419mm)	ULOD-1796- SN	3039.53	3254.61
<b>Wood — Letter Depth</b>					
16.56"(421mm)	30"(762mm)	14"(356mm)	UXOL-1730- SN	\$2524.94	\$2802.34
	36"(914mm)	14"(356mm)	UXOL-1736- SN	2763.83	3065.12
	42"(1067mm)	14"(356mm)	UXOL-1742- S	3019.11	3344.29
	48"(1219mm)	14"(356mm)	UXOL-1748- S	3258.00	3607.07
	54"(1372mm)	14"(356mm)	UXOL-1754- S	3496.89	3869.85
	60"(1524mm)	14"(356mm)	UXOL-1760- SN	3735.78	4132.63
	66"(1676mm)	14"(356mm)	UXOL-1766- SN	3974.67	4395.41
	72"(1829mm)	14"(356mm)	UXOL-1772- SN	4213.56	4658.19
	78"(1981mm)	14"(356mm)	UXOL-1778- SN	4468.84	4937.36
	84"(2134mm)	14"(356mm)	UXOL-1784- SN	4707.73	5200.14
	90"(2286mm)	14"(356mm)	UXOL-1790- SN	4946.62	5462.92
	96"(2438mm)	14"(356mm)	UXOL-1796- SN	5185.51	5725.70
<b>Wood — Legal Depth</b>					
16.56"(421mm)	30"(762mm)	16.5"(419mm)	UXOD-1730- SN	\$2767.41	\$3069.05
	36"(914mm)	16.5"(419mm)	UXOD-1736- SN	3006.30	3331.83
	42"(1067mm)	16.5"(419mm)	UXOD-1742- S	3261.58	3611.00
	48"(1219mm)	16.5"(419mm)	UXOD-1748- S	3500.47	3873.78
	54"(1372mm)	16.5"(419mm)	UXOD-1754- S	3739.36	4136.56
	60"(1524mm)	16.5"(419mm)	UXOD-1760- SN	3978.25	4399.34
	66"(1676mm)	16.5"(419mm)	UXOD-1766- SN	4217.14	4662.12
	72"(1829mm)	16.5"(419mm)	UXOD-1772- SN	4456.03	4924.90
	78"(1981mm)	16.5"(419mm)	UXOD-1778- SN	4711.31	5204.07
	84"(2134mm)	16.5"(419mm)	UXOD-1784- SN	4950.20	5466.85
	90"(2286mm)	16.5"(419mm)	UXOD-1790- SN	5189.09	5729.63
	96"(2438mm)	16.5"(419mm)	UXOD-1796- SN	5427.98	5992.41

# Masters Series

## Overhead Storage Units with Hinged Doors

### Overhead Storage Units — 1.5H with Hinged Doors

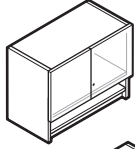

30"-36"

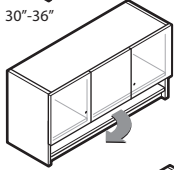

42"-54"

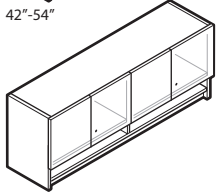

60"-72"

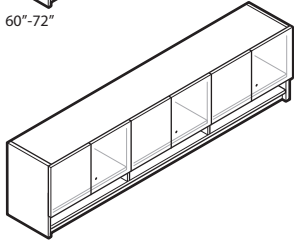

78"-96"

ULQL-SN  
ULOD-SN  
UXOL-SN  
UXOD-SN  
ULQL-SL  
ULOD-SL  
UXOL-SL  
UXOD-SL

### Features

- Includes storage cabinet(s) with hinged doors, 3.25"(83mm) cubbies, 2"(51mm) integrated light valance and 4"(102mm) French cleat with anti-dislodgement feature.
- 42"(1067mm), 48"(1219mm) and 54"(1372mm) wide units available with choice of left or right door swing for single door.
- Common keys within each unit.
- Lock plug is available in black or chrome.
- For lock options, refer to Lock Program section of the Accessories Price List.
- Shipped assembled.

### Specification Tips

- Accommodates separately specified tackboards and lighting accessories.
- Must be properly anchored to a structural wall.
- Anchors are not provided, must be field supplied.

### To Order, Specify:

- 1) Product number, including:

#### ① Lock Option:

- N** No Lock
- L** Lock  
30"-36", add **\$169.05** list  
42"-72", add **\$338.10** list  
78"-96", add **\$507.16** list

#### ② Single Door Swing Orientation:

(42", 48" and 54" wide only)

- L** Left-hand
- R** Right-hand

- 2) Finish code (laminate or wood).
- 3) Laminate edge trim color (if laminate specified).
- 4) Trim color for lock (if specified).

**Masters Series**

Overhead Storage Units with Hinged Doors

Height	Width	Depth	Number ① ②	Laminate	
				A	B
<b>Laminate — Letter Depth</b>					
21"(533mm)	14"(356mm)	30"(762mm)	ULOL-2130- SN	\$1591.72	\$1692.53
		36"(914mm)	ULOL-2136- SN	1755.14	1869.30
		42"(1067mm)	ULOL-2142- S	1934.95	2062.46
		48"(1219mm)	ULOL-2148- S	2098.37	2239.23
		54"(1372mm)	ULOL-2154- S	2261.79	2416.00
		60"(1524mm)	ULOL-2160- SN	2425.21	2592.77
		66"(1676mm)	ULOL-2166- SN	2588.63	2769.54
		72"(1829mm)	ULOL-2172- SN	2752.05	2946.31
		78"(1981mm)	ULOL-2178- SN	2931.86	3139.47
		84"(2134mm)	ULOL-2184- SN	3095.28	3316.24
		90"(2286mm)	ULOL-2190- SN	3258.70	3493.01
96"(2438mm)	ULOL-2196- SN	3422.12	3669.78		
<b>Laminate — Legal Depth</b>					
21"(533mm)	16.5"(419mm)	30"(762mm)	ULOD-2130- SN	\$1740.65	\$1853.37
		36"(914mm)	ULOD-2136- SN	1904.07	2030.14
		42"(1067mm)	ULOD-2142- S	2083.88	2223.30
		48"(1219mm)	ULOD-2148- S	2247.30	2400.07
		54"(1372mm)	ULOD-2154- S	2410.72	2576.84
		60"(1524mm)	ULOD-2160- SN	2574.14	2753.61
		66"(1676mm)	ULOD-2166- SN	2737.56	2930.38
		72"(1829mm)	ULOD-2172- SN	2900.98	3107.15
		78"(1981mm)	ULOD-2178- SN	3080.79	3300.31
		84"(2134mm)	ULOD-2184- SN	3244.21	3477.08
		90"(2286mm)	ULOD-2190- SN	3407.63	3653.85
96"(2438mm)	ULOD-2196- SN	3571.05	3830.62		
<b>Wood — Letter Depth</b>					
21"(533mm)	14"(356mm)	30"(762mm)	UXOL-2130- SN	\$2809.42	\$3115.06
		36"(914mm)	UXOL-2136- SN	3111.17	3447.00
		42"(1067mm)	UXOL-2142- S	3429.31	3795.33
		48"(1219mm)	UXOL-2148- S	3731.06	4127.27
		54"(1372mm)	UXOL-2154- S	4032.81	4459.21
		60"(1524mm)	UXOL-2160- SN	4334.56	4791.15
		66"(1676mm)	UXOL-2166- SN	4636.31	5123.09
		72"(1829mm)	UXOL-2172- SN	4938.06	5455.03
		78"(1981mm)	UXOL-2178- SN	5256.20	5803.36
		84"(2134mm)	UXOL-2184- SN	5557.95	6135.30
		90"(2286mm)	UXOL-2190- SN	5859.70	6467.24
96"(2438mm)	UXOL-2196- SN	6161.45	6799.18		
<b>Wood — Legal Depth</b>					
21"(533mm)	16.5"(419mm)	30"(762mm)	UXOD-2130- SN	\$3051.89	\$3381.77
		36"(914mm)	UXOD-2136- SN	3353.64	3713.71
		42"(1067mm)	UXOD-2142- S	3671.78	4062.04
		48"(1219mm)	UXOD-2148- S	3973.53	4393.98
		54"(1372mm)	UXOD-2154- S	4275.28	4725.92
		60"(1524mm)	UXOD-2160- SN	4577.03	5057.86
		66"(1676mm)	UXOD-2166- SN	4878.78	5389.80
		72"(1829mm)	UXOD-2172- SN	5180.53	5721.74
		78"(1981mm)	UXOD-2178- SN	5498.67	6070.07
		84"(2134mm)	UXOD-2184- SN	5800.42	6402.01
		90"(2286mm)	UXOD-2190- SN	6102.17	6733.95
96"(2438mm)	UXOD-2196- SN	6403.92	7065.89		

# Masters Series

## Overhead Storage Units with Hinged Doors

### Overhead Storage Units — 2H with Hinged Doors

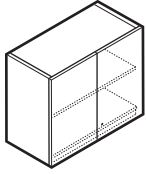

ULOL-SN  
ULOD-SN  
UXOL-SN  
UXOD-SN  
30" and 36" widths

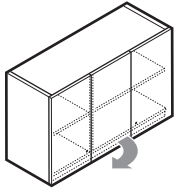

ULOL-SL  
ULOD-SL  
UXOL-SL  
UXOD-SL  
42", 48" and 54" widths  
(Left-hand single door swing shown)

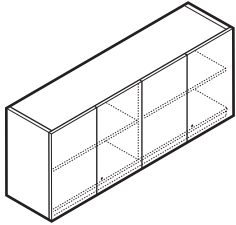

ULOL-SN  
ULOD-SN  
UXOL-SN  
UXOD-SN  
60", 66" and 72" widths

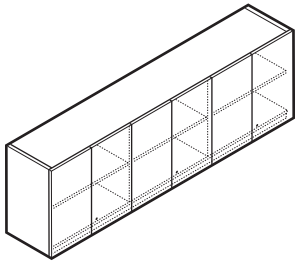

ULOL-SN  
ULOD-SN  
UXOL-SN  
UXOD-SN  
78", 84", 90" and 96" widths

### Features

- Includes storage cabinet(s) with hinged doors, 2"(51mm) integrated light valance, one adjustable shelf and 4"(102mm) French cleat with anti-dislodgement feature.
- 42"(1067mm), 48"(1219mm) and 54"(1372mm) wide units available with choice of left or right door swing for single door.
- Common keys within each unit.
- Lock plug is available in black or chrome.
- For lock options, refer to Lock Program section of the Accessories Price List.
- Shipped assembled.

### Specification Tips

- Accommodates separately specified tackboards and lighting accessories.
- Must be properly anchored to a structural wall.
- Anchors are not provided, must be field supplied.

### To Order, Specify:

- 1) Product number, including:

#### 1 Lock Option:

- N** No Lock
- L** Lock  
30"-36", add **\$169.05** list  
42"-72", add **\$338.10** list  
78"-96", add **\$507.16** list

#### 2 Single Door Swing Orientation:

(42", 48" and 54" wide only)

- L** Left-hand
- R** Right-hand

- 2) Finish code (laminated or wood).
- 3) Laminate edge trim color (if laminate specified).
- 4) Trim color for lock (if specified).

**Masters Series**

Overhead Storage Units with Hinged Doors

Height	Width	Depth	Number ① ②	Laminate	
				A	B
<b>Laminate — Letter Depth</b>					
29.125"(740mm)	30"(762mm)	14"(356mm)	ULOL-2930- SN	\$1900.60	\$2025.49
	36"(914mm)	14"(356mm)	ULOL-2936- SN	2064.02	2202.26
	42"(1067mm)	14"(356mm)	ULOL-2942- S	2243.83	2395.42
	48"(1219mm)	14"(356mm)	ULOL-2948- S	2407.25	2572.19
	54"(1372mm)	14"(356mm)	ULOL-2954- S	2570.67	2748.96
	60"(1524mm)	14"(356mm)	ULOL-2960- SN	2734.09	2925.73
	66"(1676mm)	14"(356mm)	ULOL-2966- SN	2897.51	3102.50
	72"(1829mm)	14"(356mm)	ULOL-2972- SN	3060.93	3279.27
	78"(1981mm)	14"(356mm)	ULOL-2978- SN	3240.74	3472.43
	84"(2134mm)	14"(356mm)	ULOL-2984- SN	3404.16	3649.20
	90"(2286mm)	14"(356mm)	ULOL-2990- SN	3567.58	3825.97
	96"(2438mm)	14"(356mm)	ULOL-2996- SN	3731.00	4002.74
<b>Laminate — Legal Depth</b>					
29.125"(740mm)	30"(762mm)	16.5"(419mm)	ULOD-2930- SN	\$2049.53	\$2186.33
	36"(914mm)	16.5"(419mm)	ULOD-2936- SN	2212.95	2363.10
	42"(1067mm)	16.5"(419mm)	ULOD-2942- S	2392.76	2556.26
	48"(1219mm)	16.5"(419mm)	ULOD-2948- S	2556.18	2733.03
	54"(1372mm)	16.5"(419mm)	ULOD-2954- S	2719.60	2909.80
	60"(1524mm)	16.5"(419mm)	ULOD-2960- SN	2883.02	3086.57
	66"(1676mm)	16.5"(419mm)	ULOD-2966- SN	3046.44	3263.34
	72"(1829mm)	16.5"(419mm)	ULOD-2972- SN	3209.86	3440.11
	78"(1981mm)	16.5"(419mm)	ULOD-2978- SN	3389.67	3633.27
	84"(2134mm)	16.5"(419mm)	ULOD-2984- SN	3553.09	3810.04
	90"(2286mm)	16.5"(419mm)	ULOD-2990- SN	3716.51	3986.81
	96"(2438mm)	16.5"(419mm)	ULOD-2996- SN	3879.93	4163.58
<b>Wood — Letter Depth</b>					
29.125"(740mm)	30"(762mm)	14"(356mm)	UXOL-2930- SN	\$3378.38	\$3740.50
	36"(914mm)	14"(356mm)	UXOL-2936- SN	3680.13	4072.44
	42"(1067mm)	14"(356mm)	UXOL-2942- S	3998.27	4420.77
	48"(1219mm)	14"(356mm)	UXOL-2948- S	4300.02	4752.71
	54"(1372mm)	14"(356mm)	UXOL-2954- S	4601.77	5084.65
	60"(1524mm)	14"(356mm)	UXOL-2960- SN	4903.52	5416.59
	66"(1676mm)	14"(356mm)	UXOL-2966- SN	5205.27	5748.53
	72"(1829mm)	14"(356mm)	UXOL-2972- SN	5507.02	6080.47
	78"(1981mm)	14"(356mm)	UXOL-2978- SN	5825.16	6428.80
	84"(2134mm)	14"(356mm)	UXOL-2984- SN	6126.91	6760.74
	90"(2286mm)	14"(356mm)	UXOL-2990- SN	6428.66	7092.68
	96"(2438mm)	14"(356mm)	UXOL-2996- SN	6730.41	7424.62
<b>Wood — Legal Depth</b>					
29.125"(740mm)	30"(762mm)	16.5"(419mm)	UXOD-2930- SN	\$3620.85	\$4007.21
	36"(914mm)	16.5"(419mm)	UXOD-2936- SN	3922.60	4339.15
	42"(1067mm)	16.5"(419mm)	UXOD-2942- S	4240.74	4687.48
	48"(1219mm)	16.5"(419mm)	UXOD-2948- S	4542.49	5019.42
	54"(1372mm)	16.5"(419mm)	UXOD-2954- S	4844.24	5351.36
	60"(1524mm)	16.5"(419mm)	UXOD-2960- SN	5145.99	5683.30
	66"(1676mm)	16.5"(419mm)	UXOD-2966- SN	5447.74	6015.24
	72"(1829mm)	16.5"(419mm)	UXOD-2972- SN	5749.49	6347.18
	78"(1981mm)	16.5"(419mm)	UXOD-2978- SN	6067.63	6695.51
	84"(2134mm)	16.5"(419mm)	UXOD-2984- SN	6369.38	7027.45
	90"(2286mm)	16.5"(419mm)	UXOD-2990- SN	6671.13	7359.39
	96"(2438mm)	16.5"(419mm)	UXOD-2996- SN	6972.88	7691.33

# Masters Series

## Overhead Storage Units with Sliding Door

### Overhead Storage Units — 1H with Sliding Door

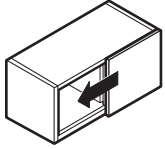

30" and 36" widths

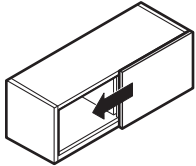

42", 48" and 54" widths

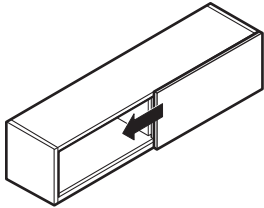

60", 66" and 72" widths

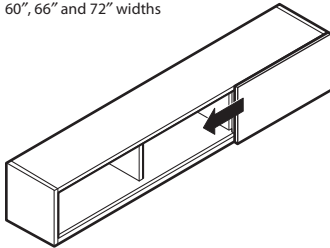

78", 84", 90" and 96" widths

ULRL-SN  
ULRD-SN  
UXRL-SN  
UXRD-SN

### Features

- Includes storage cabinet(s) with one sliding door, 2"(51mm) integrated light valance and 4"(102mm) French cleat with anti-dislodgement feature.
- Units 30"-72"(762mm-1829mm) wide include two equal width sections divided by one inset intermediate center support.
- Units 78"-96"(1981mm-2438mm) wide include three equal width sections divided by two inset intermediate center supports.
- Sliding door width is equal to one section width (one-half or one-third of unit width).
- Locks not available.
- Includes internally mounted sliding door track top and bottom with bumpers at each end.
- Shipped assembled.

### Specification Tips

- Accommodates separately specified tackboards and lighting accessories.
- Must be properly anchored to a structural wall.
- Anchors are not provided, must be field supplied.

### To Order, Specify:

- 1) Product number.
- 2) Finish code (laminated or wood).
- 3) Laminate edge trim color (if laminate specified).



**Masters Series**

Overhead Storage Units with Sliding Door

Height	Width	Depth	Number	Laminate	
				A	B
<b>Laminate — Letter Depth</b>					
16.56"(421mm)	30"(762mm)	14"(356mm)	ULRL-1730-NSN	\$1314.39	\$1392.54
	36"(914mm)	14"(356mm)	ULRL-1736-NSN	1430.93	1518.40
	42"(1067mm)	14"(356mm)	ULRL-1742-NSN	1563.86	1660.65
	48"(1219mm)	14"(356mm)	ULRL-1748-NSN	1680.40	1786.51
	54"(1372mm)	14"(356mm)	ULRL-1754-NSN	1796.94	1912.37
	60"(1524mm)	14"(356mm)	ULRL-1760-NSN	1913.48	2038.23
	66"(1676mm)	14"(356mm)	ULRL-1766-NSN	2030.02	2164.09
	72"(1829mm)	14"(356mm)	ULRL-1772-NSN	2146.56	2289.95
	78"(1981mm)	14"(356mm)	ULRL-1778-NSN	2279.49	2432.20
	84"(2134mm)	14"(356mm)	ULRL-1784-NSN	2396.03	2558.06
	90"(2286mm)	14"(356mm)	ULRL-1790-NSN	2512.57	2683.92
	96"(2438mm)	14"(356mm)	ULRL-1796-NSN	2629.11	2809.78
<b>Laminate — Legal Depth</b>					
16.56"(421mm)	30"(762mm)	16.5"(419mm)	ULRD-1730-NSN	\$1463.32	\$1553.38
	36"(914mm)	16.5"(419mm)	ULRD-1736-NSN	1579.86	1679.24
	42"(1067mm)	16.5"(419mm)	ULRD-1742-NSN	1712.79	1821.49
	48"(1219mm)	16.5"(419mm)	ULRD-1748-NSN	1829.33	1947.35
	54"(1372mm)	16.5"(419mm)	ULRD-1754-NSN	1945.87	2073.21
	60"(1524mm)	16.5"(419mm)	ULRD-1760-NSN	2062.41	2199.07
	66"(1676mm)	16.5"(419mm)	ULRD-1766-NSN	2178.95	2324.93
	72"(1829mm)	16.5"(419mm)	ULRD-1772-NSN	2295.49	2450.79
	78"(1981mm)	16.5"(419mm)	ULRD-1778-NSN	2428.42	2593.04
	84"(2134mm)	16.5"(419mm)	ULRD-1784-NSN	2544.96	2718.90
	90"(2286mm)	16.5"(419mm)	ULRD-1790-NSN	2661.50	2844.76
	96"(2438mm)	16.5"(419mm)	ULRD-1796-NSN	2778.04	2970.62
<b>Wood</b>					
Height	Width	Depth	Number	Wood	
				Group A	Group B
<b>Wood — Letter Depth</b>					
16.56"(421mm)	30"(762mm)	14"(356mm)	UXRL-1730-NSN	\$2255.51	\$2505.97
	36"(914mm)	14"(356mm)	UXRL-1736-NSN	2471.06	2743.05
	42"(1067mm)	14"(356mm)	UXRL-1742-NSN	2703.00	2996.52
	48"(1219mm)	14"(356mm)	UXRL-1748-NSN	2918.55	3233.60
	54"(1372mm)	14"(356mm)	UXRL-1754-NSN	3134.10	3470.68
	60"(1524mm)	14"(356mm)	UXRL-1760-NSN	3349.65	3707.76
	66"(1676mm)	14"(356mm)	UXRL-1766-NSN	3565.20	3944.84
	72"(1829mm)	14"(356mm)	UXRL-1772-NSN	3780.75	4181.92
	78"(1981mm)	14"(356mm)	UXRL-1778-NSN	4012.69	4435.39
	84"(2134mm)	14"(356mm)	UXRL-1784-NSN	4228.24	4672.47
	90"(2286mm)	14"(356mm)	UXRL-1790-NSN	4443.79	4909.55
	96"(2438mm)	14"(356mm)	UXRL-1796-NSN	4659.34	5146.63
<b>Wood — Legal Depth</b>					
16.56"(421mm)	30"(762mm)	16.5"(419mm)	UXRD-1730-NSN	\$2497.98	\$2772.68
	36"(914mm)	16.5"(419mm)	UXRD-1736-NSN	2713.53	3009.76
	42"(1067mm)	16.5"(419mm)	UXRD-1742-NSN	2945.47	3263.23
	48"(1219mm)	16.5"(419mm)	UXRD-1748-NSN	3161.02	3500.31
	54"(1372mm)	16.5"(419mm)	UXRD-1754-NSN	3376.57	3737.39
	60"(1524mm)	16.5"(419mm)	UXRD-1760-NSN	3592.12	3974.47
	66"(1676mm)	16.5"(419mm)	UXRD-1766-NSN	3807.67	4211.55
	72"(1829mm)	16.5"(419mm)	UXRD-1772-NSN	4023.22	4448.63
	78"(1981mm)	16.5"(419mm)	UXRD-1778-NSN	4255.16	4702.10
	84"(2134mm)	16.5"(419mm)	UXRD-1784-NSN	4470.71	4939.18
	90"(2286mm)	16.5"(419mm)	UXRD-1790-NSN	4686.26	5176.26
	96"(2438mm)	16.5"(419mm)	UXRD-1796-NSN	4901.81	5413.34

# Masters Series

## Overhead Storage Units with Sliding Door

### Overhead Storage Units — 1.5H with Sliding Door

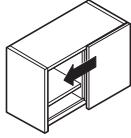

30" & 36"

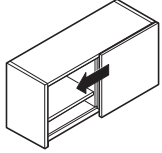

42", 48", & 54"

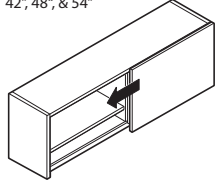

60", 66", & 72"

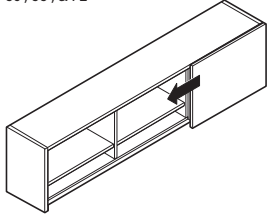

78", 84", 90" & 96"

ULRL-SN  
ULRD-SN  
UXRL-SN  
UXRD-SN

### Features

- Includes storage cabinet(s) with one sliding door, 3.25"(83mm) cubbies, 2"(51mm) integrated light valance and 4"(102mm) French cleat with anti-dislodgement feature.
- Units 30"-72"(762mm-1829mm) wide include two equal width sections divided by one inset intermediate center support.
- Units 78"-96"(1981mm-2438mm) wide include three equal width sections divided by two inset intermediate center supports.
- Sliding door width is equal to one section width (one-half or one-third of unit width).
- Locks not available.
- Includes internally mounted sliding door track top and bottom with bumpers at each end.
- Shipped assembled.

### Specification Tips

- Accommodates separately specified tackboards and lighting accessories.
- Must be properly anchored to a structural wall.
- Anchors are not provided, must be field supplied.

### To Order, Specify:

- 1) Product number.
- 2) Finish code (laminated or wood).
- 3) Laminate edge trim color (if laminate specified).

**Masters Series**

Overhead Storage Units with Sliding Door

Height	Depth	Width	Number	Laminate	
				A	B
<b>Laminate — Letter Depth</b>					
21"(533mm)	14"(356mm)	30"(762mm)	ULRL-2130-NSN	\$1407.47	\$1493.10
		36"(914mm)	ULRL-2136-NSN	1558.29	1656.19
		42"(1067mm)	ULRL-2142-NSN	1725.50	1835.67
		48"(1219mm)	ULRL-2148-NSN	1876.32	1998.76
		54"(1372mm)	ULRL-2154-NSN	2027.14	2161.85
		60"(1524mm)	ULRL-2160-NSN	2177.96	2324.94
		66"(1676mm)	ULRL-2166-NSN	2328.78	2488.03
		72"(1829mm)	ULRL-2172-NSN	2479.60	2651.12
		78"(1981mm)	ULRL-2178-NSN	2646.81	2830.60
		84"(2134mm)	ULRL-2184-NSN	2797.63	2993.69
		90"(2286mm)	ULRL-2190-NSN	2948.45	3156.78
96"(2438mm)	ULRL-2196-NSN	3099.27	3319.87		
<b>Laminate — Legal Depth</b>					
21"(533mm)	16.5"(419mm)	30"(762mm)	ULRD-2130-NSN	\$1556.40	\$1653.94
		36"(914mm)	ULRD-2136-NSN	1707.22	1817.03
		42"(1067mm)	ULRD-2142-NSN	1874.43	1996.51
		48"(1219mm)	ULRD-2148-NSN	2025.25	2159.60
		54"(1372mm)	ULRD-2154-NSN	2176.07	2322.69
		60"(1524mm)	ULRD-2160-NSN	2326.89	2485.78
		66"(1676mm)	ULRD-2166-NSN	2477.71	2648.87
		72"(1829mm)	ULRD-2172-NSN	2628.53	2811.96
		78"(1981mm)	ULRD-2178-NSN	2795.74	2991.44
		84"(2134mm)	ULRD-2184-NSN	2946.56	3154.53
		90"(2286mm)	ULRD-2190-NSN	3097.38	3317.62
96"(2438mm)	ULRD-2196-NSN	3248.20	3480.71		
<b>Wood — Letter Depth</b>					
21"(533mm)	14"(356mm)	30"(762mm)	UXRL-2130-NSN	\$2426.15	\$2693.65
		36"(914mm)	UXRL-2136-NSN	2704.56	2999.89
		42"(1067mm)	UXRL-2142-NSN	2999.36	3322.52
		48"(1219mm)	UXRL-2148-NSN	3277.77	3628.76
		54"(1372mm)	UXRL-2154-NSN	3556.18	3935.00
		60"(1524mm)	UXRL-2160-NSN	3834.59	4241.24
		66"(1676mm)	UXRL-2166-NSN	4113.00	4547.48
		72"(1829mm)	UXRL-2172-NSN	4391.41	4853.72
		78"(1981mm)	UXRL-2178-NSN	4686.21	5176.35
		84"(2134mm)	UXRL-2184-NSN	4964.62	5482.59
		90"(2286mm)	UXRL-2190-NSN	5243.03	5788.83
96"(2438mm)	UXRL-2196-NSN	5521.44	6095.07		
<b>Wood — Legal Depth</b>					
21"(533mm)	16.5"(419mm)	30"(762mm)	UXRD-2130-NSN	\$2668.62	\$2960.36
		36"(914mm)	UXRD-2136-NSN	2947.03	3266.60
		42"(1067mm)	UXRD-2142-NSN	3241.83	3589.23
		48"(1219mm)	UXRD-2148-NSN	3520.24	3895.47
		54"(1372mm)	UXRD-2154-NSN	3798.65	4201.71
		60"(1524mm)	UXRD-2160-NSN	4077.06	4507.95
		66"(1676mm)	UXRD-2166-NSN	4355.47	4814.19
		72"(1829mm)	UXRD-2172-NSN	4633.88	5120.43
		78"(1981mm)	UXRD-2178-NSN	4928.68	5443.06
		84"(2134mm)	UXRD-2184-NSN	5207.09	5749.30
		90"(2286mm)	UXRD-2190-NSN	5485.50	6055.54
96"(2438mm)	UXRD-2196-NSN	5763.91	6361.78		

# Masters Series

## Overhead Storage Units with Sliding Door

### Overhead Storage Units — 2H with Sliding Door

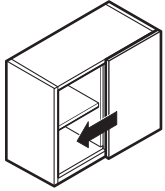

30" and 36" widths

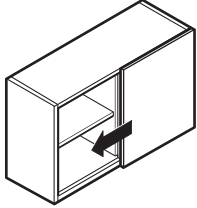

42", 48" and 54" widths

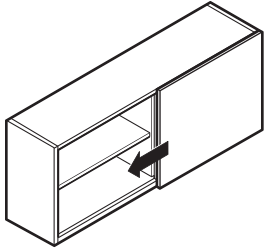

60", 66" and 72" widths

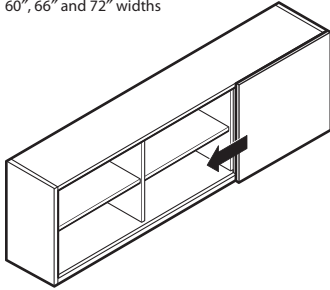

78", 84", 90" and 96" widths

ULRL-SN  
ULRD-SN  
UXRL-SN  
UXRD-SN

### Features

- Includes storage cabinet(s) with one sliding door, 2" (51mm) integrated light valance, one adjustable shelf and 4" (102mm) French cleat with anti-dislodgement feature.
- Units 30"-72" (762mm-1829mm) wide include two equal width sections divided by one inset intermediate center support.
- Units 78"-96" (1981mm-2438mm) wide include three equal width sections divided by two inset intermediate center supports.
- Sliding door width is equal to one section width (one-half or one-third of unit width).
- Locks not available.
- Includes internally mounted sliding door track top and bottom with bumpers at each end.
- Shipped assembled.

### Specification Tips

- Accommodates separately specified tackboards and lighting accessories.
- Must be properly anchored to a structural wall.
- Anchors are not provided, must be field supplied.

### To Order, Specify:

- 1) Product number.
- 2) Finish code (laminated or wood).
- 3) Laminate edge trim color (if laminate specified).

**Masters Series**

Overhead Storage Units with Sliding Door

Height	Width	Depth	Number	Laminate	
				A	B
<b>Laminate — Letter Depth</b>					
29.125"(740mm)	30"(762mm)	14"(356mm)	ULRL-2930-NSN	\$1593.63	\$1694.22
	36"(914mm)	14"(356mm)	ULRL-2936-NSN	1744.45	1857.31
	42"(1067mm)	14"(356mm)	ULRL-2942-NSN	1911.66	2036.79
	48"(1219mm)	14"(356mm)	ULRL-2948-NSN	2062.48	2199.88
	54"(1372mm)	14"(356mm)	ULRL-2954-NSN	2213.30	2362.97
	60"(1524mm)	14"(356mm)	ULRL-2960-NSN	2364.12	2526.06
	66"(1676mm)	14"(356mm)	ULRL-2966-NSN	2514.94	2689.15
	72"(1829mm)	14"(356mm)	ULRL-2972-NSN	2665.76	2852.24
	78"(1981mm)	14"(356mm)	ULRL-2978-NSN	2832.97	3031.72
	84"(2134mm)	14"(356mm)	ULRL-2984-NSN	2983.79	3194.81
	90"(2286mm)	14"(356mm)	ULRL-2990-NSN	3134.61	3357.90
	96"(2438mm)	14"(356mm)	ULRL-2996-NSN	3285.43	3520.99
<b>Laminate — Legal Depth</b>					
29.125"(740mm)	30"(762mm)	16.5"(419mm)	ULRD-2930-NSN	\$1742.56	\$1855.06
	36"(914mm)	16.5"(419mm)	ULRD-2936-NSN	1893.38	2018.15
	42"(1067mm)	16.5"(419mm)	ULRD-2942-NSN	2060.59	2197.63
	48"(1219mm)	16.5"(419mm)	ULRD-2948-NSN	2211.41	2360.72
	54"(1372mm)	16.5"(419mm)	ULRD-2954-NSN	2362.23	2523.81
	60"(1524mm)	16.5"(419mm)	ULRD-2960-NSN	2513.05	2686.90
	66"(1676mm)	16.5"(419mm)	ULRD-2966-NSN	2663.87	2849.99
	72"(1829mm)	16.5"(419mm)	ULRD-2972-NSN	2814.69	3013.08
	78"(1981mm)	16.5"(419mm)	ULRD-2978-NSN	2981.90	3192.56
	84"(2134mm)	16.5"(419mm)	ULRD-2984-NSN	3132.72	3355.65
	90"(2286mm)	16.5"(419mm)	ULRD-2990-NSN	3283.54	3518.74
	96"(2438mm)	16.5"(419mm)	ULRD-2996-NSN	3434.36	3681.83
<b>Wood — Letter Depth</b>					
29.125"(740mm)	30"(762mm)	14"(356mm)	UXRL-2930-NSN	\$2767.43	\$3069.01
	36"(914mm)	14"(356mm)	UXRL-2936-NSN	3045.84	3375.25
	42"(1067mm)	14"(356mm)	UXRL-2942-NSN	3340.64	3697.88
	48"(1219mm)	14"(356mm)	UXRL-2948-NSN	3619.05	4004.12
	54"(1372mm)	14"(356mm)	UXRL-2954-NSN	3897.46	4310.36
	60"(1524mm)	14"(356mm)	UXRL-2960-NSN	4175.87	4616.60
	66"(1676mm)	14"(356mm)	UXRL-2966-NSN	4454.28	4922.84
	72"(1829mm)	14"(356mm)	UXRL-2972-NSN	4732.69	5229.08
	78"(1981mm)	14"(356mm)	UXRL-2978-NSN	5027.49	5551.71
	84"(2134mm)	14"(356mm)	UXRL-2984-NSN	5305.90	5857.95
	90"(2286mm)	14"(356mm)	UXRL-2990-NSN	5584.31	6164.19
	96"(2438mm)	14"(356mm)	UXRL-2996-NSN	5862.72	6470.43
<b>Wood — Legal Depth</b>					
29.125"(740mm)	30"(762mm)	16.5"(419mm)	UXRD-2930-NSN	\$3009.90	\$3335.72
	36"(914mm)	16.5"(419mm)	UXRD-2936-NSN	3288.31	3641.96
	42"(1067mm)	16.5"(419mm)	UXRD-2942-NSN	3583.11	3964.59
	48"(1219mm)	16.5"(419mm)	UXRD-2948-NSN	3861.52	4270.83
	54"(1372mm)	16.5"(419mm)	UXRD-2954-NSN	4139.93	4577.07
	60"(1524mm)	16.5"(419mm)	UXRD-2960-NSN	4418.34	4883.31
	66"(1676mm)	16.5"(419mm)	UXRD-2966-NSN	4696.75	5189.55
	72"(1829mm)	16.5"(419mm)	UXRD-2972-NSN	4975.16	5495.79
	78"(1981mm)	16.5"(419mm)	UXRD-2978-NSN	5269.96	5818.42
	84"(2134mm)	16.5"(419mm)	UXRD-2984-NSN	5548.37	6124.66
	90"(2286mm)	16.5"(419mm)	UXRD-2990-NSN	5826.78	6430.90
	96"(2438mm)	16.5"(419mm)	UXRD-2996-NSN	6105.19	6737.14

# Masters Series

## Overhead Storage Units with Glass Hinged Doors

### Overhead Storage Units — 1H with Glass Hinged Doors

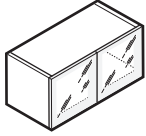

ULML-SN  
ULMD-SN  
UXML-SN  
UXMD-SN  
30" and 36" widths

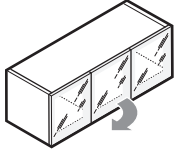

ULML-SL  
ULMD-SL  
UXML-SL  
UXMD-SL  
42", 48" and 54" widths  
(Left-hand single door swing shown)

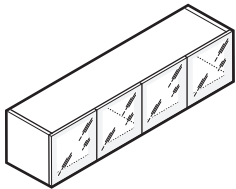

ULML-SN  
ULMD-SN  
UXML-SN  
UXMD-SN  
60", 66" and 72" widths

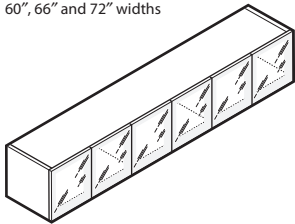

ULML-SN  
ULMD-SN  
UXML-SN  
UXMD-SN  
78", 84", 90" and 96" widths

### Features

- Includes storage cabinet(s) with glass doors, 2" (51mm) integrated light valance and 4" (102mm) French cleat with anti-dislodgement feature.
- 42" (1067mm), 48" (1219mm) and 54" (1372mm) wide units available with choice of left or right door swing for single door.
- Locks not available.
- Glass door includes metal frame with metallic powdercoat finish on back side of door.
- Glass doors will be field installed.

### Specification Tips

- Accommodates separately specified tackboards and lighting accessories.
- Must be properly anchored to a structural wall.
- Anchors are not provided, must be field supplied.

### To Order, Specify:

- 1) Product number.

#### ① Single Door Swing Orientation: (42", 48" and 54" wide only)

**L** Left-hand

**R** Right-hand

- 2) Finish code (laminated or wood).
- 3) Laminate edge trim color (if laminate specified).
- 4) Glass code.
- 5) Trim color for glass frame (required - metallic paint only).

# Masters Series

Overhead Storage Units with Glass Hinged Doors

Height	Width	Depth	Number ①	Laminate A Glass				Laminate B Glass			
				A	C	D	F	A	C	D	F
<b>Letter Depth</b>											
16.56"(421mm)	30"(762mm)	14"(356mm)	ULML-1730-NSN	\$2024.37	\$2328.46	\$2501.76	\$2907.71	\$2083.94	\$2388.03	\$2561.33	\$2967.28
	36"(914mm)	14"(356mm)	ULML-1736-NSN	2171.40	2486.47	2667.10	3083.04	2239.90	2554.97	2735.60	3151.54
	42"(1067mm)	14"(356mm)	ULML-1742-NS ■	2334.82	2660.87	2848.83	3274.76	2412.25	2738.30	2926.26	3352.19
	48"(1219mm)	14"(356mm)	ULML-1748-NS ■	2481.85	2818.88	3014.17	3450.09	2568.21	2905.24	3100.53	3536.45
	54"(1372mm)	14"(356mm)	ULML-1754-NS ■	2628.88	2976.89	3179.51	3625.42	2724.17	3072.18	3274.80	3720.71
	60"(1524mm)	14"(356mm)	ULML-1760-NSN	2775.91	3134.90	3344.85	3800.75	2880.13	3239.12	3449.07	3904.97
	66"(1676mm)	14"(356mm)	ULML-1766-NSN	2922.94	3292.91	3510.19	3976.08	3036.09	3406.06	3623.34	4089.23
	72"(1829mm)	14"(356mm)	ULML-1772-NSN	3069.97	3450.92	3675.53	4151.41	3192.05	3573.00	3797.61	4273.49
	78"(1981mm)	14"(356mm)	ULML-1778-NSN	3233.39	3625.32	3857.26	4343.13	3364.40	3756.33	3988.27	4474.14
	84"(2134mm)	14"(356mm)	ULML-1784-NSN	3380.42	3783.33	4022.60	4518.46	3520.36	3923.27	4162.54	4658.40
	90"(2286mm)	14"(356mm)	ULML-1790-NSN	3527.45	3941.34	4187.94	4693.79	3676.32	4090.21	4336.81	4842.66
	96"(2438mm)	14"(356mm)	ULML-1796-NSN	3674.48	4099.35	4353.28	4869.12	3832.28	4257.15	4511.08	5026.92
<b>Legal Depth</b>											
16.56"(421mm)	30"(762mm)	16.5"(419mm)	ULMD-1730-NSN	\$2173.30	\$2477.39	\$2650.69	\$3056.64	\$2244.78	\$2548.87	\$2722.17	\$3128.12
	36"(914mm)	16.5"(419mm)	ULMD-1736-NSN	2320.33	2635.40	2816.03	3231.97	2400.74	2715.81	2896.44	3312.38
	42"(1067mm)	16.5"(419mm)	ULMD-1742-NS ■	2483.75	2809.80	2997.76	3423.69	2573.09	2899.14	3087.10	3513.03
	48"(1219mm)	16.5"(419mm)	ULMD-1748-NS ■	2630.78	2967.81	3163.10	3599.02	2729.05	3066.08	3261.37	3697.29
	54"(1372mm)	16.5"(419mm)	ULMD-1754-NS ■	2777.81	3125.82	3328.44	3774.35	2885.01	3233.02	3435.64	3881.55
	60"(1524mm)	16.5"(419mm)	ULMD-1760-NSN	2924.84	3283.83	3493.78	3949.68	3040.97	3399.96	3609.91	4065.81
	66"(1676mm)	16.5"(419mm)	ULMD-1766-NSN	3071.87	3441.84	3659.12	4125.01	3196.93	3566.90	3784.18	4250.07
	72"(1829mm)	16.5"(419mm)	ULMD-1772-NSN	3218.90	3599.85	3824.46	4300.34	3352.89	3733.84	3958.45	4434.33
	78"(1981mm)	16.5"(419mm)	ULMD-1778-NSN	3382.32	3774.25	4006.19	4492.06	3525.24	3917.17	4149.11	4634.98
	84"(2134mm)	16.5"(419mm)	ULMD-1784-NSN	3529.35	3932.26	4171.53	4667.39	3681.20	4084.11	4323.38	4819.24
	90"(2286mm)	16.5"(419mm)	ULMD-1790-NSN	3676.38	4090.27	4336.87	4842.72	3837.16	4251.05	4497.65	5003.50
	96"(2438mm)	16.5"(419mm)	ULMD-1796-NSN	3823.41	4248.28	4502.21	5018.05	3993.12	4417.99	4671.92	5187.76

Height	Width	Depth	Number ①	Wood Group A Glass				Wood Group B Glass			
				A	C	D	F	A	C	D	F
<b>Letter Depth</b>											
16.56"(421mm)	30"(762mm)	14"(356mm)	UXML-1730-NSN	\$2758.47	\$3062.56	\$3235.86	\$3641.81	\$2964.03	\$3268.12	\$3441.42	\$3847.37
	36"(914mm)	14"(356mm)	UXML-1736-NSN	3000.36	3315.43	3496.06	3912.00	3226.56	3541.63	3722.26	4138.20
	42"(1067mm)	14"(356mm)	UXML-1742-NS ■	3258.64	3584.69	3772.65	4198.58	3505.48	3831.53	4019.49	4445.42
	48"(1219mm)	14"(356mm)	UXML-1748-NS ■	3500.53	3837.56	4032.85	4468.77	3768.01	4105.04	4300.33	4736.25
	54"(1372mm)	14"(356mm)	UXML-1754-NS ■	3742.42	4090.43	4293.05	4738.96	4030.54	4378.55	4581.17	5027.08
	60"(1524mm)	14"(356mm)	UXML-1760-NSN	3984.31	4343.30	4553.25	5009.15	4293.07	4652.06	4862.01	5317.91
	66"(1676mm)	14"(356mm)	UXML-1766-NSN	4226.20	4596.17	4813.45	5279.34	4555.60	4925.57	5142.85	5608.74
	72"(1829mm)	14"(356mm)	UXML-1772-NSN	4468.09	4849.04	5073.65	5549.53	4818.13	5199.08	5423.69	5899.57
	78"(1981mm)	14"(356mm)	UXML-1778-NSN	4726.37	5118.30	5350.24	5836.11	5097.05	5488.98	5720.92	6206.79
	84"(2134mm)	14"(356mm)	UXML-1784-NSN	4968.26	5371.17	5610.44	6106.30	5359.58	5762.49	6001.76	6497.62
	90"(2286mm)	14"(356mm)	UXML-1790-NSN	5210.15	5624.04	5870.64	6376.49	5622.11	6036.00	6282.60	6788.45
	96"(2438mm)	14"(356mm)	UXML-1796-NSN	5452.04	5876.91	6130.84	6646.68	5884.64	6309.51	6563.44	7079.28
<b>Legal Depth</b>											
16.56"(421mm)	30"(762mm)	16.5"(419mm)	UXMD-1730-NSN	\$3000.94	\$3305.03	\$3478.33	\$3884.28	\$3230.74	\$3534.83	\$3708.13	\$4114.08
	36"(914mm)	16.5"(419mm)	UXMD-1736-NSN	3242.83	3557.90	3738.53	4154.47	3493.27	3808.34	3988.97	4404.91
	42"(1067mm)	16.5"(419mm)	UXMD-1742-NS ■	3501.11	3827.16	4015.12	4441.05	3772.19	4098.24	4286.20	4712.13
	48"(1219mm)	16.5"(419mm)	UXMD-1748-NS ■	3743.00	4080.03	4275.32	4711.24	4034.72	4371.75	4567.04	5002.96
	54"(1372mm)	16.5"(419mm)	UXMD-1754-NS ■	3984.89	4332.90	4535.52	4981.43	4297.25	4645.26	4847.88	5293.79
	60"(1524mm)	16.5"(419mm)	UXMD-1760-NSN	4226.78	4585.77	4795.72	5251.62	4559.78	4918.77	5128.72	5584.62
	66"(1676mm)	16.5"(419mm)	UXMD-1766-NSN	4468.67	4838.64	5055.92	5521.81	4822.31	5192.28	5409.56	5875.45
	72"(1829mm)	16.5"(419mm)	UXMD-1772-NSN	4710.56	5091.51	5316.12	5792.00	5084.84	5465.79	5690.40	6166.28
	78"(1981mm)	16.5"(419mm)	UXMD-1778-NSN	4968.84	5360.77	5592.71	6078.58	5363.76	5755.69	5987.63	6473.50
	84"(2134mm)	16.5"(419mm)	UXMD-1784-NSN	5210.73	5613.64	5852.91	6348.77	5626.29	6029.20	6268.47	6764.33
	90"(2286mm)	16.5"(419mm)	UXMD-1790-NSN	5452.62	5866.51	6113.11	6618.96	5888.82	6302.71	6549.31	7055.16
	96"(2438mm)	16.5"(419mm)	UXMD-1796-NSN	5694.51	6119.38	6373.31	6889.15	6151.35	6576.22	6830.15	7345.99

# Masters Series

## Overhead Storage Units with Glass Hinged Doors

### Overhead Storage Units — 1.5H with Glass Hinged Doors

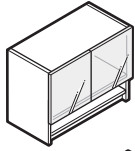

30"-36"

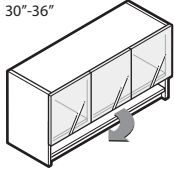

42"-54"

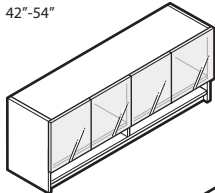

60"-72"

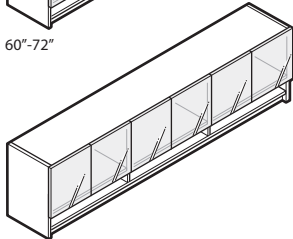

78"-96"

ULML-SN  
ULMD-SN  
UXML-SN  
UXMD-SN  
ULML-SL  
ULMD-SL  
UXML-SL  
UXMD-SL

### Features

- Includes storage cabinet(s) with non-locking glass doors, 3.25"(83mm) cubbies, 2"(51mm) integrated light valance and 4"(102mm) French cleat with anti-dislodgement feature.
- 42"(1067mm), 48"(1219mm) and 54"(1372mm) wide units available with choice of left or right door swing for single door.
- Locks not available.
- Glass door includes metal frame with metallic powdercoat finish on back side of door.
- Glass doors will be field installed.

### Specification Tips

- Accommodates separately specified tackboards and lighting accessories.
- Must be properly anchored to a structural wall.
- Anchors are not provided, must be field supplied.

### To Order, Specify:

- 1) Product number.

#### ① Single Door Swing Orientation: (42", 48" and 54" wide only)

**L** Left-hand

**R** Right-hand

- 2) Finish code (laminated or wood).
- 3) Laminate edge trim color (if laminate specified).
- 4) Glass code.
- 5) Trim color for glass frame (required - metallic paint only).



# Masters Series

## Overhead Storage Units with Glass Hinged Doors

Height	Width	Depth	Number	①	Laminate A Glass				Laminate B Glass			
					A	C	D	F	A	C	D	F
<b>Letter Depth</b>												
21"(533mm)	14"(356mm)	30"(762mm)	ULML-2130-NSN		\$2263.09	\$2617.18	\$2823.80	\$3267.07	\$2328.86	\$2682.95	\$2889.57	\$3332.84
		36"(914mm)	ULML-2136-NSN		2444.40	2809.47	3023.42	3476.68	2522.05	2887.12	3101.07	3554.33
		42"(1067mm)	ULML-2142-NS		2642.10	3018.15	3239.43	3702.68	2731.63	3107.68	3328.96	3792.21
		48"(1219mm)	ULML-2148-NS		2823.41	3210.44	3439.05	3912.29	2924.82	3311.85	3540.46	4013.70
		54"(1372mm)	ULML-2154-NS		3004.72	3402.73	3638.67	4121.90	3118.01	3516.02	3751.96	4235.19
		60"(1524mm)	ULML-2160-NSN		3186.03	3595.02	3838.29	4331.51	3311.20	3720.19	3963.46	4456.68
		66"(1676mm)	ULML-2166-NSN		3367.34	3787.31	4037.91	4541.12	3504.39	3924.36	4174.96	4678.17
		72"(1829mm)	ULML-2172-NSN		3548.65	3979.60	4237.53	4750.73	3697.58	4128.53	4386.46	4899.66
		78"(1981mm)	ULML-2178-NSN		3746.35	4188.28	4453.54	4976.73	3907.16	4349.09	4614.35	5137.54
		84"(2134mm)	ULML-2184-NSN		3927.66	4380.57	4653.16	5186.34	4100.35	4553.26	4825.85	5359.03
		90"(2286mm)	ULML-2190-NSN		4108.97	4572.86	4852.78	5395.95	4293.54	4757.43	5037.35	5580.52
		96"(2438mm)	ULML-2196-NSN		4290.28	4765.15	5052.40	5605.56	4486.73	4961.60	5248.85	5802.01
<b>Legal Depth</b>												
21"(533mm)	16.5"(419mm)	30"(762mm)	ULMD-2130-NSN		\$2412.02	\$2766.11	\$2972.73	\$3416.00	\$2489.70	\$2843.79	\$3050.41	\$3493.68
		36"(914mm)	ULMD-2136-NSN		2593.33	2958.40	3172.35	3625.61	2682.89	3047.96	3261.91	3715.17
		42"(1067mm)	ULMD-2142-NS		2791.03	3167.08	3388.36	3851.61	2892.47	3268.52	3489.80	3953.05
		48"(1219mm)	ULMD-2148-NS		2972.34	3359.37	3587.98	4061.22	3085.66	3472.69	3701.30	4174.54
		54"(1372mm)	ULMD-2154-NS		3153.65	3551.66	3787.60	4270.83	3278.85	3676.86	3912.80	4396.03
		60"(1524mm)	ULMD-2160-NSN		3334.96	3743.95	3987.22	4480.44	3472.04	3881.03	4124.30	4617.52
		66"(1676mm)	ULMD-2166-NSN		3516.27	3936.24	4186.84	4690.05	3665.23	4085.20	4335.80	4839.01
		72"(1829mm)	ULMD-2172-NSN		3697.58	4128.53	4386.46	4899.66	3858.42	4289.37	4547.30	5060.50
		78"(1981mm)	ULMD-2178-NSN		3895.28	4337.21	4602.47	5125.66	4068.00	4509.93	4775.19	5298.38
		84"(2134mm)	ULMD-2184-NSN		4076.59	4529.50	4802.09	5335.27	4261.19	4714.10	4986.69	5519.87
		90"(2286mm)	ULMD-2190-NSN		4257.90	4721.79	5001.71	5544.88	4454.38	4918.27	5198.19	5741.36
		96"(2438mm)	ULMD-2196-NSN		4439.21	4914.08	5201.33	5754.49	4647.57	5122.44	5409.69	5962.85

Height	Width	Depth	Number	①	Wood Group A Glass				Wood Group B Glass			
					A	C	D	F	A	C	D	F
<b>Letter Depth</b>												
21"(533mm)	14"(356mm)	30"(762mm)	UXML-2130-NSN		\$3061.67	\$3415.76	\$3622.38	\$4065.65	\$3281.35	\$3635.44	\$3842.06	\$4285.33
		36"(914mm)	UXML-2136-NSN		3366.42	3731.49	3945.44	4398.70	3613.04	3978.11	4192.06	4645.32
		42"(1067mm)	UXML-2142-NS		3687.56	4063.61	4284.89	4748.14	3961.12	4337.17	4558.45	5021.70
		48"(1219mm)	UXML-2148-NS		3992.31	4379.34	4607.95	5081.19	4292.81	4679.84	4908.45	5381.69
		54"(1372mm)	UXML-2154-NS		4297.06	4695.07	4931.01	5414.24	4624.50	5022.51	5258.45	5741.68
		60"(1524mm)	UXML-2160-NSN		4601.81	5010.80	5254.07	5747.29	4956.19	5365.18	5608.45	6101.67
		66"(1676mm)	UXML-2166-NSN		4906.56	5326.53	5577.13	6080.34	5287.88	5707.85	5958.45	6461.66
		72"(1829mm)	UXML-2172-NSN		5211.31	5642.26	5900.19	6413.39	5619.57	6050.52	6308.45	6821.65
		78"(1981mm)	UXML-2178-NSN		5532.45	5974.38	6239.64	6762.83	5967.65	6409.58	6674.84	7198.03
		84"(2134mm)	UXML-2184-NSN		5837.20	6290.11	6562.70	7095.88	6299.34	6752.25	7024.84	7558.02
		90"(2286mm)	UXML-2190-NSN		6141.95	6605.84	6885.76	7428.93	6631.03	7094.92	7374.84	7918.01
		96"(2438mm)	UXML-2196-NSN		6446.70	6921.57	7208.82	7761.98	6962.72	7437.59	7724.84	8278.00
<b>Legal Depth</b>												
21"(533mm)	16.5"(419mm)	30"(762mm)	UXMD-2130-NSN		\$3304.14	\$3658.23	\$3864.85	\$4308.12	\$3548.06	\$3902.15	\$4108.77	\$4552.04
		36"(914mm)	UXMD-2136-NSN		3608.89	3973.96	4187.91	4641.17	3879.75	4244.82	4458.77	4912.03
		42"(1067mm)	UXMD-2142-NS		3930.03	4306.08	4527.36	4990.61	4227.83	4603.88	4825.16	5288.41
		48"(1219mm)	UXMD-2148-NS		4234.78	4621.81	4850.42	5323.66	4559.52	4946.55	5175.16	5648.40
		54"(1372mm)	UXMD-2154-NS		4539.53	4937.54	5173.48	5656.71	4891.21	5289.22	5525.16	6008.39
		60"(1524mm)	UXMD-2160-NSN		4844.28	5253.27	5496.54	5989.76	5222.90	5631.89	5875.16	6368.38
		66"(1676mm)	UXMD-2166-NSN		5149.03	5569.00	5819.60	6322.81	5554.59	5974.56	6225.16	6728.37
		72"(1829mm)	UXMD-2172-NSN		5453.78	5884.73	6142.66	6655.86	5886.28	6317.23	6575.16	7088.36
		78"(1981mm)	UXMD-2178-NSN		5774.92	6216.85	6482.11	7005.30	6234.36	6676.29	6941.55	7464.74
		84"(2134mm)	UXMD-2184-NSN		6079.67	6532.58	6805.17	7338.35	6566.05	7018.96	7291.55	7824.73
		90"(2286mm)	UXMD-2190-NSN		6384.42	6848.31	7128.23	7671.40	6897.74	7361.63	7641.55	8184.72
		96"(2438mm)	UXMD-2196-NSN		6689.17	7164.04	7451.29	8004.45	7229.43	7704.30	7991.55	8544.71

# Masters Series

## Overhead Storage Units with Glass Hinged Doors

### Overhead Storage Units — 2H with Glass Hinged Doors

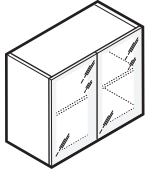

ULML-SN  
ULMD-SN  
UXML-SN  
UXMD-SN  
30" and 36" widths

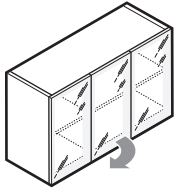

ULML-SL  
ULMD-SL  
UXML-SL  
UXMD-SL  
42", 48" and 54" widths  
(Left-hand single door swing shown)

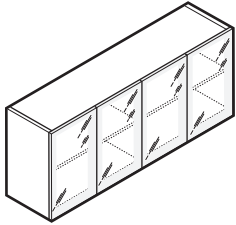

ULML-SN  
ULMD-SN  
UXML-SN  
UXMD-SN  
60", 66" and 72" widths

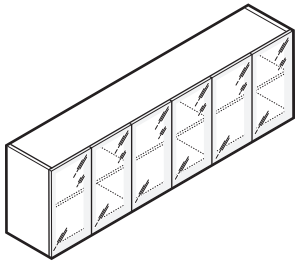

ULML-SN  
ULMD-SN  
UXML-SN  
UXMD-SN  
78", 84", 90" and 96" widths

### Features

- Includes storage cabinet(s) with glass doors, 2"(51mm) integrated light valance, one adjustable shelf and 4"(102mm) French cleat with anti-dislodgement feature.
- 42"(1067mm), 48"(1219mm) and 54"(1372mm) wide units available with choice of left or right door swing for single door.
- One interior .75"(19mm) thick wood shelf with  $\pm 1.25$ "(32mm) adjustment range.
- Locks not available.
- Glass door includes metal frame with metallic powdercoat finish on back side of door.
- Glass doors will be field installed.

### Specification Tips

- Accommodates separately specified tackboards and lighting accessories.
- Must be properly anchored to a structural wall.
- Anchors are not provided, must be field supplied.

### To Order, Specify:

- 1) Product number.

#### ① Single Door Swing Orientation: (42", 48" and 54" wide only)

**L** Left-hand

**R** Right-hand

- 2) Finish code (laminated or wood).
- 3) Laminate edge trim color (if laminate specified).
- 4) Glass code.
- 5) Trim color for glass frame (required - metallic paint only).

## Masters Series

Overhead Storage Units with Glass Hinged Doors

Height	Width	Depth	Number ①	Laminate A Glass				Laminate B Glass				
				A	C	D	F	A	C	D	F	
<b>Letter Depth</b>												
29.125"(740mm)	30"(762mm)	14"(356mm)	ULML-2930-NSN	\$2740.53	\$3194.62	\$3467.88	\$3985.79	\$2818.70	\$3272.79	\$3546.05	\$4063.96	
	36"(914mm)	14"(356mm)	ULML-2936-NSN	2921.84	3386.91	3667.50	4195.40	3011.89	3476.96	3757.55	4285.45	
	42"(1067mm)	14"(356mm)	ULML-2942-NS ■	3119.54	3595.59	3883.51	4421.40	3221.47	3697.52	3985.44	4523.33	
	48"(1219mm)	14"(356mm)	ULML-2948-NS ■	3300.85	3787.88	4083.13	4631.01	3414.66	3901.69	4196.94	4744.82	
	54"(1372mm)	14"(356mm)	ULML-2954-NS ■	3482.16	3980.17	4282.75	4840.62	3607.85	4105.86	4408.44	4966.31	
	60"(1524mm)	14"(356mm)	ULML-2960-NSN	3663.47	4172.46	4482.37	5050.23	3801.04	4310.03	4619.94	5187.80	
	66"(1676mm)	14"(356mm)	ULML-2966-NSN	3844.78	4364.75	4681.99	5259.84	3994.23	4514.20	4831.44	5409.29	
	72"(1829mm)	14"(356mm)	ULML-2972-NSN	4026.09	4557.04	4881.61	5469.45	4187.42	4718.37	5042.94	5630.78	
	78"(1981mm)	14"(356mm)	ULML-2978-NSN	4223.79	4765.72	5097.62	5695.45	4397.00	4938.93	5270.83	5868.66	
	84"(2134mm)	14"(356mm)	ULML-2984-NSN	4405.10	4958.01	5297.24	5905.06	4590.19	5143.10	5482.33	6090.15	
	90"(2286mm)	14"(356mm)	ULML-2990-NSN	4586.41	5150.30	5496.86	6114.67	4783.38	5347.27	5693.83	6311.64	
	96"(2438mm)	14"(356mm)	ULML-2996-NSN	4767.72	5342.59	5696.48	6324.28	4976.57	5551.44	5905.33	6533.13	
<b>Legal Depth</b>												
29.125"(740mm)	30"(762mm)	16.5"(419mm)	ULMD-2930-NSN	\$2889.46	\$3343.55	\$3616.81	\$4134.72	\$2979.54	\$3433.63	\$3706.89	\$4224.80	
	36"(914mm)	16.5"(419mm)	ULMD-2936-NSN	3070.77	3535.84	3816.43	4344.33	3172.73	3637.80	3918.39	4446.29	
	42"(1067mm)	16.5"(419mm)	ULMD-2942-NS ■	3268.47	3744.52	4032.44	4570.33	3382.31	3858.36	4146.28	4684.17	
	48"(1219mm)	16.5"(419mm)	ULMD-2948-NS ■	3449.78	3936.81	4232.06	4779.94	3575.50	4062.53	4357.78	4905.66	
	54"(1372mm)	16.5"(419mm)	ULMD-2954-NS ■	3631.09	4129.10	4431.68	4989.55	3768.69	4266.70	4569.28	5127.15	
	60"(1524mm)	16.5"(419mm)	ULMD-2960-NSN	3812.40	4321.39	4631.30	5199.16	3961.88	4470.87	4780.78	5348.64	
	66"(1676mm)	16.5"(419mm)	ULMD-2966-NSN	3993.71	4513.68	4830.92	5408.77	4155.07	4675.04	4992.28	5570.13	
	72"(1829mm)	16.5"(419mm)	ULMD-2972-NSN	4175.02	4705.97	5030.54	5618.38	4348.26	4879.21	5203.78	5791.62	
	78"(1981mm)	16.5"(419mm)	ULMD-2978-NSN	4372.72	4914.65	5246.55	5844.38	4557.84	5099.77	5431.67	6029.50	
	84"(2134mm)	16.5"(419mm)	ULMD-2984-NSN	4554.03	5106.94	5446.17	6053.99	4751.03	5303.94	5643.17	6250.99	
	90"(2286mm)	16.5"(419mm)	ULMD-2990-NSN	4735.34	5299.23	5645.79	6263.60	4944.22	5508.11	5854.67	6472.48	
	96"(2438mm)	16.5"(419mm)	ULMD-2996-NSN	4916.65	5491.52	5845.41	6473.21	5137.41	5712.28	6066.17	6693.97	

Height	Width	Depth	Number ①	Wood Group A Glass				Wood Group B Glass				
				A	C	D	F	A	C	D	F	
<b>Letter Depth</b>												
29.125"(740mm)	30"(762mm)	14"(356mm)	UXML-2930-NSN	\$3668.07	\$4122.16	\$4395.42	\$4913.33	\$3915.99	\$4370.08	\$4643.34	\$5161.25	
	36"(914mm)	14"(356mm)	UXML-2936-NSN	3972.82	4437.89	4718.48	5246.38	4247.68	4712.75	4993.34	5521.24	
	42"(1067mm)	14"(356mm)	UXML-2942-NS ■	4293.96	4770.01	5057.93	5595.82	4595.76	5071.81	5359.73	5897.62	
	48"(1219mm)	14"(356mm)	UXML-2948-NS ■	4598.71	5085.74	5380.99	5928.87	4927.45	5414.48	5709.73	6257.61	
	54"(1372mm)	14"(356mm)	UXML-2954-NS ■	4903.46	5401.47	5704.05	6261.92	5259.14	5757.15	6059.73	6617.60	
	60"(1524mm)	14"(356mm)	UXML-2960-NSN	5208.21	5717.20	6027.11	6594.97	5590.83	6099.82	6409.73	6977.59	
	66"(1676mm)	14"(356mm)	UXML-2966-NSN	5512.96	6032.93	6350.17	6928.02	5922.52	6442.49	6759.73	7337.58	
	72"(1829mm)	14"(356mm)	UXML-2972-NSN	5817.71	6348.66	6673.23	7261.07	6254.21	6785.16	7109.73	7697.57	
	78"(1981mm)	14"(356mm)	UXML-2978-NSN	6138.85	6680.78	7012.68	7610.51	6602.29	7144.22	7476.12	8073.95	
	84"(2134mm)	14"(356mm)	UXML-2984-NSN	6443.60	6996.51	7335.74	7943.56	6933.98	7486.89	7826.12	8433.94	
	90"(2286mm)	14"(356mm)	UXML-2990-NSN	6748.35	7312.24	7658.80	8276.61	7265.67	7829.56	8176.12	8793.93	
	96"(2438mm)	14"(356mm)	UXML-2996-NSN	7053.10	7627.97	7981.86	8609.66	7597.36	8172.23	8526.12	9153.92	
<b>Legal Depth</b>												
29.125"(740mm)	30"(762mm)	16.5"(419mm)	UXMD-2930-NSN	\$3910.54	\$4364.63	\$4637.89	\$5155.80	\$4182.70	\$4636.79	\$4910.05	\$5427.96	
	36"(914mm)	16.5"(419mm)	UXMD-2936-NSN	4215.29	4680.36	4960.95	5488.85	4514.39	4979.46	5260.05	5787.95	
	42"(1067mm)	16.5"(419mm)	UXMD-2942-NS ■	4536.43	5012.48	5300.40	5838.29	4862.47	5338.52	5626.44	6164.33	
	48"(1219mm)	16.5"(419mm)	UXMD-2948-NS ■	4841.18	5328.21	5623.46	6171.34	5194.16	5681.19	5976.44	6524.32	
	54"(1372mm)	16.5"(419mm)	UXMD-2954-NS ■	5145.93	5643.94	5946.52	6504.39	5525.85	6023.86	6326.44	6884.31	
	60"(1524mm)	16.5"(419mm)	UXMD-2960-NSN	5450.68	5959.67	6269.58	6837.44	5857.54	6366.53	6676.44	7244.30	
	66"(1676mm)	16.5"(419mm)	UXMD-2966-NSN	5755.43	6275.40	6592.64	7170.49	6189.23	6709.20	7026.44	7604.29	
	72"(1829mm)	16.5"(419mm)	UXMD-2972-NSN	6060.18	6591.13	6915.70	7503.54	6520.92	7051.87	7376.44	7964.28	
	78"(1981mm)	16.5"(419mm)	UXMD-2978-NSN	6381.32	6923.25	7255.15	7852.98	6869.00	7410.93	7742.83	8340.66	
	84"(2134mm)	16.5"(419mm)	UXMD-2984-NSN	6686.07	7238.98	7578.21	8186.03	7200.69	7753.60	8092.83	8700.65	
	90"(2286mm)	16.5"(419mm)	UXMD-2990-NSN	6990.82	7554.71	7901.27	8519.08	7532.38	8096.27	8442.83	9060.64	
	96"(2438mm)	16.5"(419mm)	UXMD-2996-NSN	7295.57	7870.44	8224.33	8852.13	7864.07	8438.94	8792.83	9420.63	

# Masters Series

## Overhead Storage Units with Glass Sliding Door

### Overhead Storage Units — 1H with Glass Sliding Door

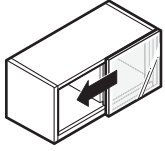

30" and 36" widths

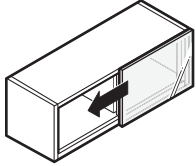

42", 48" and 54" widths

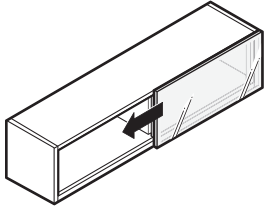

60", 66" and 72" widths

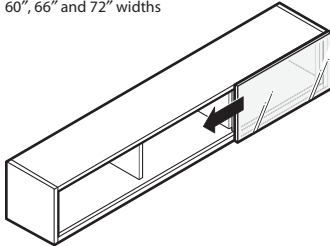

78", 84", 90" and 96" widths

ULLL-SN  
ULLD-SN  
UXLL-SN  
UXLD-SN

### Features

- Includes storage cabinet(s) with one glass sliding door, 2"(51mm) integrated light valance and 4"(102mm) French cleat with anti-dislodgement feature.
- Units 30"-72"(762mm-1829mm) wide include two equal width sections divided by one inset intermediate center support.
- Units 78"-96"(1981mm-2438mm) wide include three equal width sections divided by two inset intermediate center supports.
- Sliding door width equal to one section width (one-half or one-third of unit width).
- Locks not available.
- Glass door includes metal frame with metallic powdercoat finish on back side of door.
- Includes internally mounted sliding door track top and bottom with bumpers at each end.
- Glass doors will be field installed.

### Specification Tips

- Accommodates separately specified tackboards and lighting accessories.
- Must be properly anchored to a structural wall.
- Anchors are not provided, must be field supplied.
- Only back-painted glass available as standard; specifying alternate glass may allow for the light valance and hardware to be visible.

### To Order, Specify:

- 1) Product number.
- 2) Finish code (laminated or wood).
- 3) Laminate edge trim color (if laminate specified).
- 4) Glass code.
- 5) Trim color for glass frame (required - metallic paint only).

# Masters Series

Overhead Storage Units with Glass Sliding Door

Height	Width	Depth	Number	Laminate A Glass				Laminate B Glass			
				A	C	D	F	A	C	D	F
<b>Letter Depth</b>											
16.56"(421mm)	30"(762mm)	14"(356mm)	ULLL-1730-NSN	\$1627.78	\$1800.25	\$1915.34	\$2072.40	\$1687.35	\$1859.82	\$1974.91	\$2131.97
	36"(914mm)	14"(356mm)	ULLL-1736-NSN	1769.78	1951.64	2073.02	2238.62	1838.28	2020.14	2141.52	2307.12
	42"(1067mm)	14"(356mm)	ULLL-1742-NSN	1928.17	2119.42	2247.09	2421.23	2005.60	2196.85	2324.52	2498.66
	48"(1219mm)	14"(356mm)	ULLL-1748-NSN	2070.17	2270.81	2404.77	2587.45	2156.53	2357.17	2491.13	2673.81
	54"(1372mm)	14"(356mm)	ULLL-1754-NSN	2212.17	2422.20	2562.45	2753.67	2307.46	2517.49	2657.74	2848.96
	60"(1524mm)	14"(356mm)	ULLL-1760-NSN	2354.17	2573.59	2720.13	2919.89	2458.39	2677.81	2824.35	3024.11
	66"(1676mm)	14"(356mm)	ULLL-1766-NSN	2496.17	2724.98	2877.81	3086.11	2609.32	2838.13	2990.96	3199.26
	72"(1829mm)	14"(356mm)	ULLL-1772-NSN	2638.17	2876.37	3035.49	3252.33	2760.25	2998.45	3157.57	3374.41
	78"(1981mm)	14"(356mm)	ULLL-1778-NSN	2796.56	3044.15	3209.56	3434.94	2927.57	3175.16	3340.57	3565.95
	84"(2134mm)	14"(356mm)	ULLL-1784-NSN	2938.56	3195.54	3367.24	3601.16	3078.50	3335.48	3507.18	3741.10
	90"(2286mm)	14"(356mm)	ULLL-1790-NSN	3080.56	3346.93	3524.92	3767.38	3229.43	3495.80	3673.79	3916.25
	96"(2438mm)	14"(356mm)	ULLL-1796-NSN	3222.56	3498.32	3682.60	3933.60	3380.36	3656.12	3840.40	4091.40
<b>Legal Depth</b>											
16.56"(421mm)	30"(762mm)	16.5"(419mm)	ULLD-1730-NSN	\$1776.71	\$1949.18	\$2064.27	\$2221.33	\$1848.19	\$2020.66	\$2135.75	\$2292.81
	36"(914mm)	16.5"(419mm)	ULLD-1736-NSN	1918.71	2100.57	2221.95	2387.55	1999.12	2180.98	2302.36	2467.96
	42"(1067mm)	16.5"(419mm)	ULLD-1742-NSN	2077.10	2268.35	2396.02	2570.16	2166.44	2357.69	2485.36	2659.50
	48"(1219mm)	16.5"(419mm)	ULLD-1748-NSN	2219.10	2419.74	2553.70	2736.38	2317.37	2518.01	2651.97	2834.65
	54"(1372mm)	16.5"(419mm)	ULLD-1754-NSN	2361.10	2571.13	2711.38	2902.60	2468.30	2678.33	2818.58	3009.80
	60"(1524mm)	16.5"(419mm)	ULLD-1760-NSN	2503.10	2722.52	2869.06	3068.82	2619.23	2838.65	2985.19	3184.95
	66"(1676mm)	16.5"(419mm)	ULLD-1766-NSN	2645.10	2873.91	3026.74	3235.04	2770.16	2998.97	3151.80	3360.10
	72"(1829mm)	16.5"(419mm)	ULLD-1772-NSN	2787.10	3025.30	3184.42	3401.26	2921.09	3159.29	3318.41	3535.25
	78"(1981mm)	16.5"(419mm)	ULLD-1778-NSN	2945.49	3193.08	3358.49	3583.87	3088.41	3336.00	3501.41	3726.79
	84"(2134mm)	16.5"(419mm)	ULLD-1784-NSN	3087.49	3344.47	3516.17	3750.09	3239.34	3496.32	3668.02	3901.94
	90"(2286mm)	16.5"(419mm)	ULLD-1790-NSN	3229.49	3495.86	3673.85	3916.31	3390.27	3656.64	3834.63	4077.09
	96"(2438mm)	16.5"(419mm)	ULLD-1796-NSN	3371.49	3647.25	3831.53	4082.53	3541.20	3816.96	4001.24	4252.24

Height	Width	Depth	Number	Wood Group A Glass				Wood Group B Glass			
				A	C	D	F	A	C	D	F
<b>Letter Depth</b>											
16.56"(421mm)	30"(762mm)	14"(356mm)	UXLL-1730-NSN	\$2361.88	\$2534.35	\$2649.44	\$2806.50	\$2567.44	\$2739.91	\$2855.00	\$3012.06
	36"(914mm)	14"(356mm)	UXLL-1736-NSN	2598.74	2780.60	2901.98	3067.58	2824.94	3006.80	3128.18	3293.78
	42"(1067mm)	14"(356mm)	UXLL-1742-NSN	2851.99	3043.24	3170.91	3345.05	3098.83	3290.08	3417.75	3591.89
	48"(1219mm)	14"(356mm)	UXLL-1748-NSN	3088.85	3289.49	3423.45	3606.13	3356.33	3556.97	3690.93	3873.61
	54"(1372mm)	14"(356mm)	UXLL-1754-NSN	3325.71	3535.74	3675.99	3867.21	3613.83	3823.86	3964.11	4155.33
	60"(1524mm)	14"(356mm)	UXLL-1760-NSN	3562.57	3781.99	3928.53	4128.29	3871.33	4090.75	4237.29	4437.05
	66"(1676mm)	14"(356mm)	UXLL-1766-NSN	3799.43	4028.24	4181.07	4389.37	4128.83	4357.64	4510.47	4718.77
	72"(1829mm)	14"(356mm)	UXLL-1772-NSN	4036.29	4274.49	4433.61	4650.45	4386.33	4624.53	4783.65	5000.49
	78"(1981mm)	14"(356mm)	UXLL-1778-NSN	4289.54	4537.13	4702.54	4927.92	4660.22	4907.81	5073.22	5298.60
	84"(2134mm)	14"(356mm)	UXLL-1784-NSN	4526.40	4783.38	4955.08	5189.00	4917.72	5174.70	5346.40	5580.32
	90"(2286mm)	14"(356mm)	UXLL-1790-NSN	4763.26	5029.63	5207.62	5450.08	5175.22	5441.59	5619.58	5862.04
	96"(2438mm)	14"(356mm)	UXLL-1796-NSN	5000.12	5275.88	5460.16	5711.16	5432.72	5708.48	5892.76	6143.76
<b>Legal Depth</b>											
16.56"(421mm)	30"(762mm)	16.5"(419mm)	UXLD-1730-NSN	\$2604.35	\$2776.82	\$2891.91	\$3048.97	\$2834.15	\$3006.62	\$3121.71	\$3278.77
	36"(914mm)	16.5"(419mm)	UXLD-1736-NSN	2841.21	3023.07	3144.45	3310.05	3091.65	3273.51	3394.89	3560.49
	42"(1067mm)	16.5"(419mm)	UXLD-1742-NSN	3094.46	3285.71	3413.38	3587.52	3365.54	3556.79	3684.46	3858.60
	48"(1219mm)	16.5"(419mm)	UXLD-1748-NSN	3331.32	3531.96	3665.92	3848.60	3623.04	3823.68	3957.64	4140.32
	54"(1372mm)	16.5"(419mm)	UXLD-1754-NSN	3568.18	3778.21	3918.46	4109.68	3880.54	4090.57	4230.82	4422.04
	60"(1524mm)	16.5"(419mm)	UXLD-1760-NSN	3805.04	4024.46	4171.00	4370.76	4138.04	4357.46	4504.00	4703.76
	66"(1676mm)	16.5"(419mm)	UXLD-1766-NSN	4041.90	4270.71	4423.54	4631.84	4395.54	4624.35	4777.18	4985.48
	72"(1829mm)	16.5"(419mm)	UXLD-1772-NSN	4278.76	4516.96	4676.08	4892.92	4653.04	4891.24	5050.36	5267.20
	78"(1981mm)	16.5"(419mm)	UXLD-1778-NSN	4532.01	4779.60	4945.01	5170.39	4926.93	5174.52	5339.93	5565.31
	84"(2134mm)	16.5"(419mm)	UXLD-1784-NSN	4768.87	5025.85	5197.55	5431.47	5184.43	5441.41	5613.11	5847.03
	90"(2286mm)	16.5"(419mm)	UXLD-1790-NSN	5005.73	5272.10	5450.09	5692.55	5441.93	5708.30	5886.29	6128.75
	96"(2438mm)	16.5"(419mm)	UXLD-1796-NSN	5242.59	5518.35	5702.63	5953.63	5699.43	5975.19	6159.47	6410.47

# Masters Series

## Overhead Storage Units with Glass Sliding Door

### Overhead Storage Units — 1.5H with Glass Sliding Door

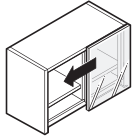

30" & 36"

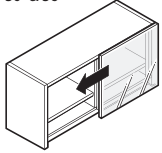

42", 48", & 54"

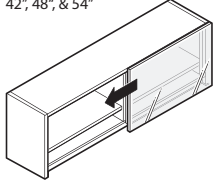

60", 66", & 72"

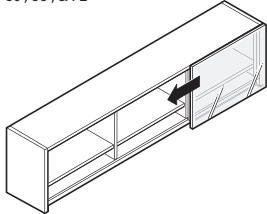

78", 84", 90" & 96"

ULLL-SN  
ULLD-SN  
UXLL-SN  
UXLD-SN

### Features

- Includes storage cabinet(s) with one non-locking glass sliding door, 3.25"(83mm) cubbies, 2"(51mm) integrated light valance and 4"(102mm) French cleat with anti-dislodgement feature.
- Units 30"-72"(762mm-1829mm) wide include two equal width sections divided by one inset intermediate center support.
- Units 78"-96"(1981mm-2438mm) wide include three equal width sections divided by two inset intermediate center supports.
- Sliding door width equal to one section width (one-half or one-third of unit width).
- Locks not available.
- Glass door includes metal frame with metallic powdercoat finish on back side of door.
- Includes internally mounted sliding door track top and bottom with bumpers at each end.
- Glass doors will be field installed.

### Specification Tips

- Accommodates separately specified tackboards and lighting accessories.
- Must be properly anchored to a structural wall.
- Anchors are not provided, must be field supplied.
- Only back-painted glass available as standard; specifying alternate glass may allow for the light valance and hardware to be visible.

### To Order, Specify:

- 1) Product number.
- 2) Finish code (laminate or wood).
- 3) Laminate edge trim color (if laminate specified).
- 4) Glass code.
- 5) Trim color for glass frame (required - metallic paint only).

## Masters Series

Overhead Storage Units with Glass Sliding Door

Height	Width	Depth	Number	Laminate A Glass				Laminate B Glass			
				A	C	D	F	A	C	D	F
<b>Letter Depth</b>											
21"(533mm)	14"(356mm)	30"(762mm)	ULLL-2130-NSN	\$1812.14	\$2017.69	\$2154.86	\$2342.04	\$1877.91	\$2083.46	\$2220.63	\$2407.81
		36"(914mm)	ULLL-2136-NSN	1988.42	2203.36	2346.82	2542.54	2066.07	2281.01	2424.47	2620.19
		42"(1067mm)	ULLL-2142-NSN	2181.09	2405.42	2555.17	2759.43	2270.62	2494.95	2644.70	2848.96
		48"(1219mm)	ULLL-2148-NSN	2357.37	2591.09	2747.13	2959.93	2458.78	2692.50	2848.54	3061.34
		54"(1372mm)	ULLL-2154-NSN	2533.65	2776.76	2939.09	3160.43	2646.94	2890.05	3052.38	3273.72
		60"(1524mm)	ULLL-2160-NSN	2709.93	2962.43	3131.05	3360.93	2835.10	3087.60	3256.22	3486.10
		66"(1676mm)	ULLL-2166-NSN	2886.21	3148.10	3323.01	3561.43	3023.26	3285.15	3460.06	3698.48
		72"(1829mm)	ULLL-2172-NSN	3062.49	3333.77	3514.97	3761.93	3211.42	3482.70	3663.90	3910.86
		78"(1981mm)	ULLL-2178-NSN	3255.16	3535.83	3723.32	3978.82	3415.97	3696.64	3884.13	4139.63
		84"(2134mm)	ULLL-2184-NSN	3431.44	3721.50	3915.28	4179.32	3604.13	3894.19	4087.97	4352.01
		90"(2286mm)	ULLL-2190-NSN	3607.72	3907.17	4107.24	4379.82	3792.29	4091.74	4291.81	4564.39
		96"(2438mm)	ULLL-2196-NSN	3784.00	4092.84	4299.20	4580.32	3980.45	4289.29	4495.65	4776.77
<b>Legal Depth</b>											
21"(533mm)	16.5"(419mm)	30"(762mm)	ULLD-2130-NSN	\$1961.07	\$2166.62	\$2303.79	\$2490.97	\$2038.75	\$2244.30	\$2381.47	\$2568.65
		36"(914mm)	ULLD-2136-NSN	2137.35	2352.29	2495.75	2691.47	2226.91	2441.85	2585.31	2781.03
		42"(1067mm)	ULLD-2142-NSN	2330.02	2554.35	2704.10	2908.36	2431.46	2655.79	2805.54	3009.80
		48"(1219mm)	ULLD-2148-NSN	2506.30	2740.02	2896.06	3108.86	2619.62	2853.34	3009.38	3222.18
		54"(1372mm)	ULLD-2154-NSN	2682.58	2925.69	3088.02	3309.36	2807.78	3050.89	3213.22	3434.56
		60"(1524mm)	ULLD-2160-NSN	2858.86	3111.36	3279.98	3509.86	2995.94	3248.44	3417.06	3646.94
		66"(1676mm)	ULLD-2166-NSN	3035.14	3297.03	3471.94	3710.36	3184.10	3445.99	3620.90	3859.32
		72"(1829mm)	ULLD-2172-NSN	3211.42	3482.70	3663.90	3910.86	3372.26	3643.54	3824.74	4071.70
		78"(1981mm)	ULLD-2178-NSN	3404.09	3684.76	3872.25	4127.75	3576.81	3857.48	4044.97	4300.47
		84"(2134mm)	ULLD-2184-NSN	3580.37	3870.43	4064.21	4328.25	3764.97	4055.03	4248.81	4512.85
		90"(2286mm)	ULLD-2190-NSN	3756.65	4056.10	4256.17	4528.75	3953.13	4252.58	4452.65	4725.23
		96"(2438mm)	ULLD-2196-NSN	3932.93	4241.77	4448.13	4729.25	4141.29	4450.13	4656.49	4937.61

Height	Width	Depth	Number	Wood Group A Glass				Wood Group B Glass			
				A	C	D	F	A	C	D	F
<b>Letter Depth</b>											
21"(533mm)	14"(356mm)	30"(762mm)	UXLL-2130-NSN	\$2610.72	\$2816.27	\$2953.44	\$3140.62	\$2830.40	\$3035.95	\$3173.12	\$3360.30
		36"(914mm)	UXLL-2136-NSN	2910.44	3125.38	3268.84	3464.56	3157.06	3372.00	3515.46	3711.18
		42"(1067mm)	UXLL-2142-NSN	3226.55	3450.88	3600.63	3804.89	3500.11	3724.44	3874.19	4078.45
		48"(1219mm)	UXLL-2148-NSN	3526.27	3759.99	3916.03	4128.83	3826.77	4060.49	4216.53	4429.33
		54"(1372mm)	UXLL-2154-NSN	3825.99	4069.10	4231.43	4452.77	4153.43	4396.54	4558.87	4780.21
		60"(1524mm)	UXLL-2160-NSN	4125.71	4378.21	4546.83	4776.71	4480.09	4732.59	4901.21	5131.09
		66"(1676mm)	UXLL-2166-NSN	4425.43	4687.32	4862.23	5100.65	4806.75	5068.64	5243.55	5481.97
		72"(1829mm)	UXLL-2172-NSN	4725.15	4996.43	5177.63	5424.59	5133.41	5404.69	5585.89	5832.85
		78"(1981mm)	UXLL-2178-NSN	5041.26	5321.93	5509.42	5764.92	5476.46	5757.13	5944.62	6200.12
		84"(2134mm)	UXLL-2184-NSN	5340.98	5631.04	5824.82	6088.86	5803.12	6093.18	6286.96	6551.00
		90"(2286mm)	UXLL-2190-NSN	5640.70	5940.15	6140.22	6412.80	6129.78	6429.23	6629.30	6901.88
		96"(2438mm)	UXLL-2196-NSN	5940.42	6249.26	6455.62	6736.74	6456.44	6765.28	6971.64	7252.76
<b>Legal Depth</b>											
21"(533mm)	16.5"(419mm)	30"(762mm)	UXLD-2130-NSN	\$2853.19	\$3058.74	\$3195.91	\$3383.09	\$3097.11	\$3302.66	\$3439.83	\$3627.01
		36"(914mm)	UXLD-2136-NSN	3152.91	3367.85	3511.31	3707.03	3423.77	3638.71	3782.17	3977.89
		42"(1067mm)	UXLD-2142-NSN	3469.02	3693.35	3843.10	4047.36	3766.82	3991.15	4140.90	4345.16
		48"(1219mm)	UXLD-2148-NSN	3768.74	4002.46	4158.50	4371.30	4093.48	4327.20	4483.24	4696.04
		54"(1372mm)	UXLD-2154-NSN	4068.46	4311.57	4473.90	4695.24	4420.14	4663.25	4825.58	5046.92
		60"(1524mm)	UXLD-2160-NSN	4368.18	4620.68	4789.30	5019.18	4746.80	4999.30	5167.92	5397.80
		66"(1676mm)	UXLD-2166-NSN	4667.90	4929.79	5104.70	5343.12	5073.46	5335.35	5510.26	5748.68
		72"(1829mm)	UXLD-2172-NSN	4967.62	5238.90	5420.10	5667.06	5400.12	5671.40	5852.60	6099.56
		78"(1981mm)	UXLD-2178-NSN	5283.73	5564.40	5751.89	6007.39	5743.17	6023.84	6211.33	6466.83
		84"(2134mm)	UXLD-2184-NSN	5583.45	5873.51	6067.29	6331.33	6069.83	6359.89	6553.67	6817.71
		90"(2286mm)	UXLD-2190-NSN	5883.17	6182.62	6382.69	6655.27	6396.49	6695.94	6896.01	7168.59
		96"(2438mm)	UXLD-2196-NSN	6182.89	6491.73	6698.09	6979.21	6723.15	7031.99	7238.35	7519.47

# Masters Series

## Overhead Storage Units with Glass Sliding Door

### Overhead Storage Units — 2H with Glass Sliding Door

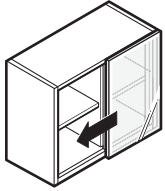

30" and 36" widths

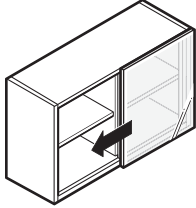

42", 48" and 54" widths

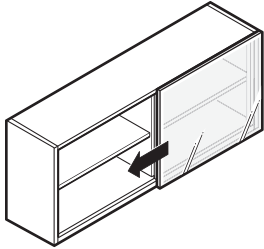

60", 66" and 72" widths

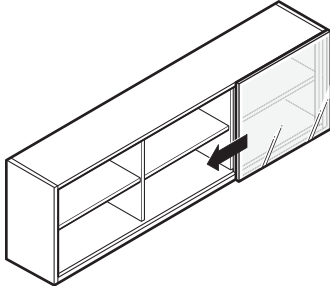

78", 84", 90" and 96" widths

ULLL-SN  
ULLD-SN  
UXLL-SN  
UXLD-SN

### Features

- Includes storage cabinet(s) with one glass sliding door, 2"(51mm) integrated light valance, one adjustable shelf and 4"(102mm) French cleat with anti-dislodgement feature.
- Units 30"-72"(762mm-1829mm) wide include two equal width sections divided by one inset intermediate center support.
- Units 78"-96"(1981mm-2438mm) wide include three equal width sections divided by two inset intermediate center supports.
- Sliding door width equal to one section width (one-half or one-third of unit width).
- One interior .75"(19mm) thick wood shelf with  $\pm 1.25"$ (32mm) adjustment range.
- Locks not available.
- Glass door includes metal frame with metallic powdercoat finish on back side of door.
- Includes internally mounted sliding door track top and bottom with bumpers at each end.
- Glass doors will be field installed.

### Specification Tips

- Accommodates separately specified tackboards and lighting accessories.
- Must be properly anchored to a structural wall.
- Anchors are not provided, must be field supplied.
- Only back-painted glass available as standard; specifying alternate glass may allow for the light valance and hardware to be visible.

### To Order, Specify:

- 1) Product number.
- 2) Finish code (laminated or wood).
- 3) Laminate edge trim color (if laminate specified).
- 4) Glass code.
- 5) Trim color for glass frame (required - metallic paint only).



**Masters Series**

Overhead Storage Units with Glass Sliding Door

Height	Width	Depth	Number	Laminate A Glass				Laminate B Glass			
				A	C	D	F	A	C	D	F
<b>Letter Depth</b>											
29.125"(740mm)	30"(762mm)	14"(356mm)	ULLL-2930-NSN	\$2180.86	\$2452.57	\$2633.90	\$2881.32	\$2259.03	\$2530.74	\$2712.07	\$2959.49
	36"(914mm)	14"(356mm)	ULLL-2936-NSN	2357.14	2638.24	2825.86	3081.82	2447.19	2728.29	2915.91	3171.87
	42"(1067mm)	14"(356mm)	ULLL-2942-NSN	2549.81	2840.30	3034.21	3298.71	2651.74	2942.23	3136.14	3400.64
	48"(1219mm)	14"(356mm)	ULLL-2948-NSN	2726.09	3025.97	3226.17	3499.21	2839.90	3139.78	3339.98	3613.02
	54"(1372mm)	14"(356mm)	ULLL-2954-NSN	2902.37	3211.64	3418.13	3699.71	3028.06	3337.33	3543.82	3825.40
	60"(1524mm)	14"(356mm)	ULLL-2960-NSN	3078.65	3397.31	3610.09	3900.21	3216.22	3534.88	3747.66	4037.78
	66"(1676mm)	14"(356mm)	ULLL-2966-NSN	3254.93	3582.98	3802.05	4100.71	3404.38	3732.43	3951.50	4250.16
	72"(1829mm)	14"(356mm)	ULLL-2972-NSN	3431.21	3768.65	3994.01	4301.21	3592.54	3929.98	4155.34	4462.54
	78"(1981mm)	14"(356mm)	ULLL-2978-NSN	3623.88	3970.71	4202.36	4518.10	3797.09	4143.92	4375.57	4691.31
	84"(2134mm)	14"(356mm)	ULLL-2984-NSN	3800.16	4156.38	4394.32	4718.60	3985.25	4341.47	4579.41	4903.69
	90"(2286mm)	14"(356mm)	ULLL-2990-NSN	3976.44	4342.05	4586.28	4919.10	4173.41	4539.02	4783.25	5116.07
	96"(2438mm)	14"(356mm)	ULLL-2996-NSN	4152.72	4527.72	4778.24	5119.60	4361.57	4736.57	4987.09	5328.45
<b>Legal Depth</b>											
29.125"(740mm)	30"(762mm)	16.5"(419mm)	ULLD-2930-NSN	\$2329.79	\$2601.50	\$2782.83	\$3030.25	\$2419.87	\$2691.58	\$2872.91	\$3120.33
	36"(914mm)	16.5"(419mm)	ULLD-2936-NSN	2506.07	2787.17	2974.79	3230.75	2608.03	2889.13	3076.75	3332.71
	42"(1067mm)	16.5"(419mm)	ULLD-2942-NSN	2698.74	2989.23	3183.14	3447.64	2812.58	3103.07	3296.98	3561.48
	48"(1219mm)	16.5"(419mm)	ULLD-2948-NSN	2875.02	3174.90	3375.10	3648.14	3000.74	3300.62	3500.82	3773.86
	54"(1372mm)	16.5"(419mm)	ULLD-2954-NSN	3051.30	3360.57	3567.06	3848.64	3188.90	3498.17	3704.66	3986.24
	60"(1524mm)	16.5"(419mm)	ULLD-2960-NSN	3227.58	3546.24	3759.02	4049.14	3377.06	3695.72	3908.50	4198.62
	66"(1676mm)	16.5"(419mm)	ULLD-2966-NSN	3403.86	3731.91	3950.98	4249.64	3565.22	3893.27	4112.34	4411.00
	72"(1829mm)	16.5"(419mm)	ULLD-2972-NSN	3580.14	3917.58	4142.94	4450.14	3753.38	4090.82	4316.18	4623.38
	78"(1981mm)	16.5"(419mm)	ULLD-2978-NSN	3772.81	4119.64	4351.29	4667.03	3957.93	4304.76	4536.41	4852.15
	84"(2134mm)	16.5"(419mm)	ULLD-2984-NSN	3949.09	4305.31	4543.25	4867.53	4146.09	4502.31	4740.25	5064.53
	90"(2286mm)	16.5"(419mm)	ULLD-2990-NSN	4125.37	4490.98	4735.21	5068.03	4334.25	4699.86	4944.09	5276.91
	96"(2438mm)	16.5"(419mm)	ULLD-2996-NSN	4301.65	4676.65	4927.17	5268.53	4522.41	4897.41	5147.93	5489.29

Height	Width	Depth	Number	Wood Group A Glass				Wood Group B Glass			
				A	C	D	F	A	C	D	F
<b>Letter Depth</b>											
29.125"(740mm)	30"(762mm)	14"(356mm)	UXLL-2930-NSN	\$3108.40	\$3380.11	\$3561.44	\$3808.86	\$3356.32	\$3628.03	\$3809.36	\$4056.78
	36"(914mm)	14"(356mm)	UXLL-2936-NSN	3408.12	3689.22	3876.84	4132.80	3682.98	3964.08	4151.70	4407.66
	42"(1067mm)	14"(356mm)	UXLL-2942-NSN	3724.23	4014.72	4208.63	4473.13	4026.03	4316.52	4510.43	4774.93
	48"(1219mm)	14"(356mm)	UXLL-2948-NSN	4023.95	4323.83	4524.03	4797.07	4352.69	4652.57	4852.77	5125.81
	54"(1372mm)	14"(356mm)	UXLL-2954-NSN	4323.67	4632.94	4839.43	5121.01	4679.35	4988.62	5195.11	5476.69
	60"(1524mm)	14"(356mm)	UXLL-2960-NSN	4623.39	4942.05	5154.83	5444.95	5006.01	5324.67	5537.45	5827.57
	66"(1676mm)	14"(356mm)	UXLL-2966-NSN	4923.11	5251.16	5470.23	5768.89	5332.67	5660.72	5879.79	6178.45
	72"(1829mm)	14"(356mm)	UXLL-2972-NSN	5222.83	5560.27	5785.63	6092.83	5659.33	5996.77	6222.13	6529.33
	78"(1981mm)	14"(356mm)	UXLL-2978-NSN	5538.94	5885.77	6117.42	6433.16	6002.38	6349.21	6580.86	6896.60
	84"(2134mm)	14"(356mm)	UXLL-2984-NSN	5838.66	6194.88	6432.82	6757.10	6329.04	6685.26	6923.20	7247.48
	90"(2286mm)	14"(356mm)	UXLL-2990-NSN	6138.38	6503.99	6748.22	7081.04	6655.70	7021.31	7265.54	7598.36
	96"(2438mm)	14"(356mm)	UXLL-2996-NSN	6438.10	6813.10	7063.62	7404.98	6982.36	7357.36	7607.88	7949.24
<b>Legal Depth</b>											
29.125"(740mm)	30"(762mm)	16.5"(419mm)	UXLD-2930-NSN	\$3350.87	\$3622.58	\$3803.91	\$4051.33	\$3623.03	\$3894.74	\$4076.07	\$4323.49
	36"(914mm)	16.5"(419mm)	UXLD-2936-NSN	3650.59	3931.69	4119.31	4375.27	3949.69	4230.79	4418.41	4674.37
	42"(1067mm)	16.5"(419mm)	UXLD-2942-NSN	3966.70	4257.19	4451.10	4715.60	4292.74	4583.23	4777.14	5041.64
	48"(1219mm)	16.5"(419mm)	UXLD-2948-NSN	4266.42	4566.30	4766.50	5039.54	4619.40	4919.28	5119.48	5392.52
	54"(1372mm)	16.5"(419mm)	UXLD-2954-NSN	4566.14	4875.41	5081.90	5363.48	4946.06	5255.33	5461.82	5743.40
	60"(1524mm)	16.5"(419mm)	UXLD-2960-NSN	4865.86	5184.52	5397.30	5687.42	5272.72	5591.38	5804.16	6094.28
	66"(1676mm)	16.5"(419mm)	UXLD-2966-NSN	5165.58	5493.63	5712.70	6011.36	5599.38	5927.43	6146.50	6445.16
	72"(1829mm)	16.5"(419mm)	UXLD-2972-NSN	5465.30	5802.74	6028.10	6335.30	5926.04	6263.48	6488.84	6796.04
	78"(1981mm)	16.5"(419mm)	UXLD-2978-NSN	5781.41	6128.24	6359.89	6675.63	6269.09	6615.92	6847.57	7163.31
	84"(2134mm)	16.5"(419mm)	UXLD-2984-NSN	6081.13	6437.35	6675.29	6999.57	6595.75	6951.97	7189.91	7514.19
	90"(2286mm)	16.5"(419mm)	UXLD-2990-NSN	6380.85	6746.46	6990.69	7323.51	6922.41	7288.02	7532.25	7865.07
	96"(2438mm)	16.5"(419mm)	UXLD-2996-NSN	6680.57	7055.57	7306.09	7647.45	7249.07	7624.07	7874.59	8215.95

# Masters Series

## Mounting Bracket Masters Overhead Storage Unit to Enclose

	Number	Price
	XWBB-0027	<b>\$46.38</b>
	XWBB-0030	<b>46.38</b>
	XWBB-0033	<b>46.38</b>
	XWBB-0034	<b>46.38</b>
	XWBB-0036	<b>46.38</b>
	XWBB-0039	<b>49.18</b>
	XWBB-0042	<b>49.18</b>
	XWBB-0045	<b>49.18</b>
	XWBB-0048	<b>49.18</b>

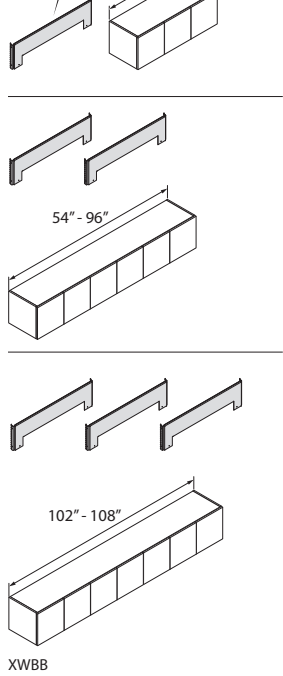

**Features**

- Includes black bracket and attachment hardware.
- One bracket for 30"(762mm)-48"(1219mm) Overhead Storage Unit. Two brackets for 54"(1372mm)-96"(2438mm) Overhead. Three brackets for 102"(2591mm)-108"(2743mm)

**To Order, Specify:**

- 1) Product number.  
(No finish specification required.)

**Specification Tips**

- Designed to be used with 1H, 1.5H and 2H overhead storage units.
- Mounting Bracket is not for use with an Open Sided Shelf.
- Bracket width must match Enclose wall width for installation purposes.
- See matrix below for bracket quantity needed for Overhead Storage Unit size.

Overhead Storage Width	Bracket Number	Quantity of Brackets(s) Needed
30"(762mm)	XWBB-0030	1
36"(914mm)	XWBB-0036	1
42"(1067mm)	XWBB-0042	1
48"(1219mm)	XWBB-0048	1
54"(1372mm)	XWBB-0027	2
60"(1524mm)	XWBB-0030	2
66"(1676mm)	XWBB-0033	2
72"(1829mm)	XWBB-0036	2
78"(1981mm)	XWBB-0039	2
84"(2134mm)	XWBB-0042	2
90"(2286mm)	XWBB-0045	2
96"(2438mm)	XWBB-0048	2
102"(2591mm)*	XWBB-0034	3
108"(2743mm)*	XWBB-0036	3

# Masters Series

## Tackboards for Overhead Storage Units — 1H and 2H

	Height	Width	Number	Fabric Grade		
				A	B	C
<b>Tackboards — Wall Mount Overhead Storage Units — Fabric</b>	22"(559mm)	30"(762mm)	MTWD-2230	\$375.28	\$ 429.62	\$ 497.51
		36"(914mm)	MTWD-2236	400.60	458.36	531.23
		42"(1067mm)	MTWD-2242	425.92	487.10	564.95
		48"(1219mm)	MTWD-2248	451.24	515.84	598.67
		54"(1372mm)	MTWD-2254	476.56	544.58	632.39
		60"(1524mm)	MTWD-2260	501.88	573.32	666.11
		66"(1676mm)	MTWD-2266	615.95	829.56	948.83
		72"(1829mm)	MTWD-2272	656.51	887.10	1014.71
		78"(1981mm)	MTWD-2278	697.07	944.64	1080.59
		84"(2134mm)	MTWD-2284	737.63	1002.18	1146.47
		90"(2286mm)	MTWD-2290	778.19	1059.72	1212.35
	96"(2438mm)	MTWD-2296	818.75	1117.26	1278.23	

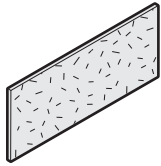

MTWD  
30"–60" wide

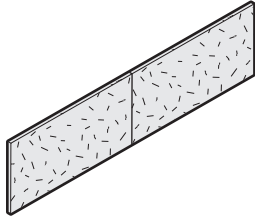

MTWD  
66"–96" wide

### Feature

- Tackboards over 60"(1524mm) wide include two fabric sections.

### Specification Tips

- Designed to mount on wall below equal width overhead storage unit or an open sided shelf.
- Not for use with overhead storage units with cubbies.

### To Order, Specify:

- Product number.
- Fabric code.

	Height	Width	Number	Fabric Grade		
				A	B	C
<b>Tackboards — Wall Mount Overhead Storage Units — Fabric and Slat Rail</b>	22"(559mm)	30"(762mm)	MTSW-2230	\$ 592.66	\$ 682.34	\$ 782.64
		36"(914mm)	MTSW-2236	634.38	730.30	837.70
		42"(1067mm)	MTSW-2242	676.10	778.26	892.76
		48"(1219mm)	MTSW-2248	717.82	826.22	947.82
		54"(1372mm)	MTSW-2254	759.54	874.18	1002.88
		60"(1524mm)	MTSW-2260	794.23	913.79	1049.04
		66"(1676mm)	MTSW-2266	875.91	1007.84	1156.79
		72"(1829mm)	MTSW-2272	957.59	1101.89	1264.54
		78"(1981mm)	MTSW-2278	1039.27	1195.94	1372.29
		84"(2134mm)	MTSW-2284	1120.95	1289.99	1480.04
		90"(2286mm)	MTSW-2290	1202.63	1384.04	1587.79
	96"(2438mm)	MTSW-2296	1284.31	1478.09	1695.54	

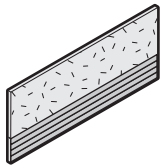

MTSW  
30"–60" wide

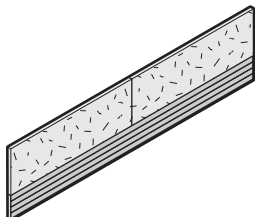

MTSW  
66"–96" wide

### Features

- Includes fabric covered tackboard(s) with slat rail.
- Tackboards over 60"(1524mm) wide include two fabric sections. Optional slat rail is one full-width section.

### Specification Tips

- Designed to mount on wall below equal width overhead storage unit or an open sided shelf.
- Slat rail accommodates separately specified Belong work tools.
- Not for use with overhead storage units with cubbies.

### To Order, Specify:

- Product number.
- Fabric code.
- Trim code for slat rail.

# Masters Series

Tackboards for Overhead Storage Units — 1.5H

	Height	Width	Number	Fabric Grade		
				A	B	C
<b>Fabric Tackboards</b>	18"(457mm)	30"(762mm)	MTWD-1830	\$324.96	\$372.10	\$ 430.71
		36"(914mm)	MTWD-1836	349.80	400.36	463.71
		42"(1067mm)	MTWD-1842	374.64	428.62	496.71
		48"(1219mm)	MTWD-1848	399.48	456.88	529.71
		54"(1372mm)	MTWD-1854	424.32	485.14	562.71
		60"(1524mm)	MTWD-1860	449.16	513.40	595.71
		66"(1676mm)	MTWD-1866	474.00	541.66	628.71
		72"(1829mm)	MTWD-1872	498.84	569.92	661.71
		78"(1981mm)	MTWD-1878	636.11	848.16	971.07
		84"(2134mm)	MTWD-1884	672.35	898.74	1029.03
		90"(2286mm)	MTWD-1890	708.59	949.32	1086.99
		96"(2438mm)	MTWD-1896	744.83	999.90	1144.95

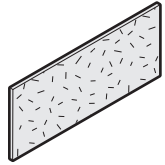
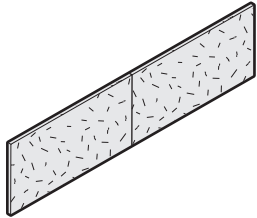
MTWD  
30"–60" wideMTWD  
66"–96" wide

### Features

- Includes fabric covered tackboard with attachment hardware.
- Tackboards over 60"(1524mm) wide include two fabric sections.

### Specification Tip

- Designed to mount on wall below equal width overhead storage unit or an open sided shelf.

### To Order, Specify:

- 1) Product number.
- 2) Fabric code.

	Height	Width	Number	Fabric Grade		
				A	B	C
<b>Fabric and Slat Rail</b>	18"(457mm)	30"(762mm)	MTSW-1830	\$ 585.70	\$ 674.34	\$ 773.41
		36"(914mm)	MTSW-1836	627.42	722.30	828.47
		42"(1067mm)	MTSW-1842	669.14	770.26	883.53
		48"(1219mm)	MTSW-1848	710.86	818.22	938.59
		54"(1372mm)	MTSW-1854	752.58	866.18	993.65
		60"(1524mm)	MTSW-1860	780.32	897.79	1030.61
		66"(1676mm)	MTSW-1866	862.00	991.84	1138.36
		72"(1829mm)	MTSW-1872	943.68	1085.89	1246.11
		78"(1981mm)	MTSW-1878	1025.36	1179.94	1353.86
		84"(2134mm)	MTSW-1884	1107.04	1273.99	1461.61
		90"(2286mm)	MTSW-1890	1188.72	1368.04	1569.36
		96"(2438mm)	MTSW-1896	1270.40	1462.09	1677.11

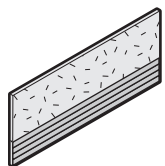
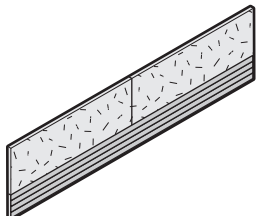
MTSW  
30"–60" wideMTSW  
66"–96" wide

### Features

- Includes fabric covered tackboard(s) with slat rail and attachment hardware.
- Tackboards over 60"(1524mm) wide include two fabric sections. Optional slat rail is one full-width section.

### Specification Tips

- Designed to mount on wall below equal width overhead storage unit or an open sided shelf.
- Slat rail accommodates separately specified Belong work tools.

### To Order, Specify:

- 1) Product number.
- 2) Fabric code.
- 3) Trim code for slat rail.

## Masters Series

Stack-On Bookcases

Height	Width	Depth	Number	Laminate		Wood	
				A	B	Group A	Group B
<b>Laminate — Letter Depth</b>							
39.9"(1013mm)	30"(762mm)	14"(356mm)	X5KL-4030-NNSN	\$1880.12	\$2005.76		
	36"(914mm)	14"(356mm)	X5KL-4036-NNSN	1951.23	2078.60		
52.5"(1334mm)	30"(762mm)	14"(356mm)	X5KL-5230-NNSN	\$2568.97	\$2695.85		
	36"(914mm)	14"(356mm)	X5KL-5236-NNSN	2662.19	2790.80		
<b>Laminate — Legal Depth</b>							
39.9"(1013mm)	30"(762mm)	16.5"(419mm)	X5KD-4030-NNSN	\$1927.51	\$2053.15		
	36"(914mm)	16.5"(419mm)	X5KD-4036-NNSN	1998.62	2125.99		
52.5"(1334mm)	30"(762mm)	16.5"(419mm)	X5KD-5230-NNSN	\$2632.15	\$2759.03		
	36"(914mm)	16.5"(419mm)	X5KD-5236-NNSN	2725.37	2853.98		
<b>Wood — Letter Depth</b>							
39.9"(1013mm)	30"(762mm)	14"(356mm)	X4KL-4030-NNSN			\$2871.10	\$3201.41
	36"(914mm)	14"(356mm)	X4KL-4036-NNSN			2942.21	3282.05
52.5"(1334mm)	30"(762mm)	14"(356mm)	X4KL-5230-NNSN			\$3710.48	\$4138.89
	36"(914mm)	14"(356mm)	X4KL-5236-NNSN			3803.70	4241.64
<b>Wood — Legal Depth</b>							
39.9"(1013mm)	30"(762mm)	16.5"(419mm)	X4KD-4030-NNSN			\$2918.49	\$3248.80
	36"(914mm)	16.5"(419mm)	X4KD-4036-NNSN			2989.60	3329.44
52.5"(1334mm)	30"(762mm)	16.5"(419mm)	X4KD-5230-NNSN			\$3773.66	\$4202.07
	36"(914mm)	16.5"(419mm)	X4KD-5236-NNSN			3866.88	4304.82

## Stack-On Bookcase

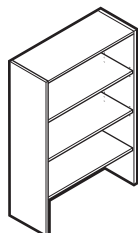
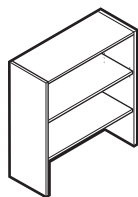

X4KL-SN  
X4KD-SN  
X5KL-SN  
X5KD-SN

## Features

- Includes unfinished back, one fixed shelf, attachment material and one adjustable shelf for 3H or two adjustable shelves for 4H unit.
- Adjustable .75"(19mm) thick shelf has  $\pm 1.25$ "(32mm) adjustment range.
- Bottom shelf is fixed.
- Shipped assembled.

## Specification Tips

- Not for use on a freestanding or standalone desk.
- Predrilled shelf locations do not align with adjacent wall mounted upper storage components.
- 39.875"(1013mm) high aligns with 5H storage units when stacked on top of 2H storage.
- 52.5"(1334mm) high aligns with 6H storage units when stacked on top of 2H storage.
- See Stack-on Application Rules in Specification Guide.
- Not designed for application where back of unit is visible.

## To Order, Specify:

- 1) Product number.
- 2) Finish Code (laminate or wood).
- 3) Laminate edge trim color (if laminate specified).

# Masters Series

## Stack-On Storage Cabinets with Hinged Doors

Height	Width	Depth	Number ①②	Laminate		Wood	
				A	B	Group A	Group B
<b>Laminate — Letter Depth</b>							
39.875"(1013mm)	30"(762mm)	14"(356mm)	X5CL-4030-■ ■ SL	\$2491.41	\$2654.04		
	36"(914mm)	14"(356mm)	X5CL-4036-■ ■ SL	2582.28	2744.91		
52.5"(1334mm)	30"(762mm)	14"(356mm)	X5CL-5230-■ ■ SL	\$3399.10	\$3561.73		
	36"(914mm)	14"(356mm)	X5CL-5236-■ ■ SL	3489.97	3652.60		
<b>Laminate — Legal Depth</b>							
39.875"(1013mm)	30"(762mm)	16.5"(419mm)	X5CD-4030-■ ■ SL	\$2570.40	\$2733.03		
	36"(914mm)	16.5"(419mm)	X5CD-4036-■ ■ SL	2661.27	2823.90		
52.5"(1334mm)	30"(762mm)	16.5"(419mm)	X5CD-5230-■ ■ SL	\$3478.09	\$3640.72		
	36"(914mm)	16.5"(419mm)	X5CD-5236-■ ■ SL	3568.96	3731.59		
<b>Wood — Letter Depth</b>							
39.875"(1013mm)	30"(762mm)	14"(356mm)	X4CL-4030-■ ■ SW			\$3846.61	\$4295.01
	36"(914mm)	14"(356mm)	X4CL-4036-■ ■ SW			3937.48	4396.83
52.5"(1334mm)	30"(762mm)	14"(356mm)	X4CL-5230-■ ■ SW			\$4754.30	\$5312.16
	36"(914mm)	14"(356mm)	X4CL-5236-■ ■ SW			4845.17	5413.98
<b>Wood — Legal Depth</b>							
39.875"(1013mm)	30"(762mm)	16.5"(419mm)	X4CD-4030-■ ■ SW			\$3925.60	\$4374.00
	36"(914mm)	16.5"(419mm)	X4CD-4036-■ ■ SW			4016.47	4475.82
52.5"(1334mm)	30"(762mm)	16.5"(419mm)	X4CD-5230-■ ■ SW			\$4833.29	\$5391.15
	36"(914mm)	16.5"(419mm)	X4CD-5236-■ ■ SW			4924.16	5492.97

### Stack-On Storage Cabinet with Hinged Doors

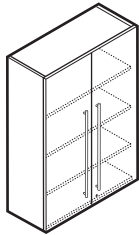
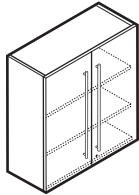

X4CL-SW  
X4CD-SW  
X5CL-SW  
X5CD-SW

### Features

- Includes unfinished back, hinged doors with concealed hinges, attachment material, two adjustable shelves for 3H or three adjustable shelves for 4H unit.
- Adjustable .75"(19mm) thick shelf has ±1.25"(32mm) adjustment range.
- Door pull options:
  - Finger pull option indicates door with touch latch.
  - Bar pulls available in powdercoat finish.
  - Linear and Classic pulls are available in satin nickel finish only.
- Optional lock available; lock plug available in black or chrome.
- For lock options, refer to Lock Program section of the Accessories Price List.
- Shipped assembled.

### Specification Tips

- Not for use on a freestanding or standalone desk.
- Predrilled shelf locations do not align with adjacent wall mounted upper storage components.
- 39.875"(1013mm) high aligns with 5H storage units when stacked on top of 2H storage.
- 52.5"(1334mm) high aligns with 6H storage units when stacked on top of 2H storage.
- See Stack-on Application Rules in Specification Guide.
- Not designed for application where back of unit is visible.

### To Order, Specify:

- 1) Product number, including:

#### ① Pull Option:

- F** Finger (Touch latch) (Wood only)
- B** Bar
- 8** Linear
- 9** Classic

#### ② Lock Option:

- N** No Lock
- L** Lock, add \$169.05 list

- 2) Finish code (laminate or wood).
- 3) Laminate edge trim color (if laminate specified).
- 4) Trim color for bar pull (if specified).
- 5) Trim color for lock (if specified).

### ① Pull Styles

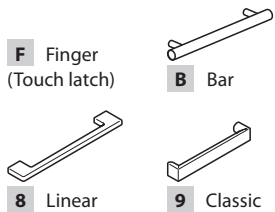

## Masters Series

Stack-On Storage Cabinets with Glass Doors

Height	Width	Depth	Number	Laminate A Glass				Laminate B Glass			
				A	C	D	F	A	C	D	F
<b>Letter Depth</b>											
39.875"(1013mm)	30"(762mm)	14"(356mm)	X5JL-4030-NNST	\$2605.66	\$3521.54	\$3775.06	\$4282.08	\$2813.96	\$3729.84	\$3983.36	\$4490.38
	36"(914mm)	14"(356mm)	X5JL-4036-NNST	2684.65	3600.53	3854.05	4361.07	2895.44	3811.32	4064.84	4571.86
52.5"(1334mm)	30"(762mm)	14"(356mm)	X5JL-5230-NNST	\$3517.29	\$4433.17	\$4686.69	\$5193.71	\$3727.32	\$4643.20	\$4896.72	\$5403.74
	36"(914mm)	14"(356mm)	X5JL-5236-NNST	3627.90	4543.78	4797.30	5304.32	3840.42	4756.30	5009.82	5516.84
<b>Legal Depth</b>											
39.875"(1013mm)	30"(762mm)	16.5"(419mm)	X5JD-4030-NNST	\$2672.00	\$3587.88	\$3841.40	\$4348.42	\$2880.30	\$3796.18	\$4049.70	\$4556.72
	36"(914mm)	16.5"(419mm)	X5JD-4036-NNST	2750.99	3666.87	3920.39	4427.41	2961.78	3877.66	4131.18	4638.20
52.5"(1334mm)	30"(762mm)	16.5"(419mm)	X5JD-5230-NNST	\$3602.59	\$4518.47	\$4771.99	\$5279.01	\$3812.62	\$4728.50	\$4982.02	\$5489.04
	36"(914mm)	16.5"(419mm)	X5JD-5236-NNST	3713.20	4629.08	4882.60	5389.62	3925.72	4841.60	5095.12	5602.14

Height	Width	Depth	Number	Wood Group A Glass				Wood Group B Glass			
				A	C	D	F	A	C	D	F
<b>Letter Depth</b>											
39.875"(1013mm)	30"(762mm)	14"(356mm)	X4JL-4030-NNST	\$3979.03	\$4894.91	\$5148.43	\$5655.45	\$4427.93	\$5343.81	\$5597.33	\$6104.35
	36"(914mm)	14"(356mm)	X4JL-4036-NNST	4058.02	4973.90	5227.42	5734.44	4516.46	5432.34	5685.86	6192.88
52.5"(1334mm)	30"(762mm)	14"(356mm)	X4JL-5230-NNST	\$5079.28	\$5995.16	\$6248.68	\$6755.70	\$5656.98	\$6572.86	\$6826.38	\$7333.40
	36"(914mm)	14"(356mm)	X4JL-5236-NNST	5189.89	6105.77	6359.29	6866.31	5777.13	6693.01	6946.53	7453.55
<b>Legal Depth</b>											
39.875"(1013mm)	30"(762mm)	16.5"(419mm)	X4JD-4030-NNST	\$4045.37	\$4961.25	\$5214.77	\$5721.79	\$4494.27	\$5410.15	\$5663.67	\$6170.69
	36"(914mm)	16.5"(419mm)	X4JD-4036-NNST	4124.36	5040.24	5293.76	5800.78	4582.80	5498.68	5752.20	6259.22
52.5"(1334mm)	30"(762mm)	16.5"(419mm)	X4JD-5230-NNST	\$5164.58	\$6080.46	\$6333.98	\$6841.00	\$5742.28	\$6658.16	\$6911.68	\$7418.70
	36"(914mm)	16.5"(419mm)	X4JD-5236-NNST	5275.19	6191.07	6444.59	6951.61	5862.43	6778.31	7031.83	7538.85

## Stack-On Storage Cabinet with Glass Doors

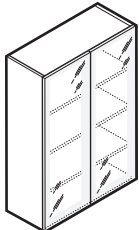
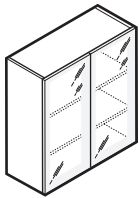

X4JL-ST  
X4JD-ST  
X5JL-ST  
X5JD-ST

## Features

- Includes unfinished back, glass doors with concealed hinges and touch latch, attachment material, two adjustable shelves for 3H or three adjustable shelves for 4H unit.
- Adjustable .75"(19mm) thick shelf has  $\pm 1.25$ "(32mm) adjustment range.
- Glass doors will be field installed.

## Specification Tips

- Not for use on a freestanding or standalone desk.
- 39.875"(1013mm) high aligns with 5H storage units.
- 52.5"(1334mm) high aligns with 6H storage units.
- Locks not available.
- See Stack-on Application Rules in Specification Guide.
- Not designed for application where back of unit is visible.

## To Order, Specify:

- 1) Product number.
- 2) Finish code (laminate or wood).
- 3) Laminate edge trim color (if laminate specified).
- 4) Glass Code.
- 5) Trim color for glass frame (required metallic paint only).

# Masters Series

## Reception Stations

Height	Depth	Width	Number ① ② ③ ④				Wood Group A	Group B
<b>Wood</b>								
44.1875"(1122mm)	82.375"(2092mm)	74 1/4"(1886mm)	Enclosure	XZLR-8272-	SS	Y	\$10938.02	\$12244.02
	29.125"(740mm)	72"(1829mm)	Desk					
	18.125"(460mm)	48"(1219mm)	Return					

### L-Shaped Reception Station

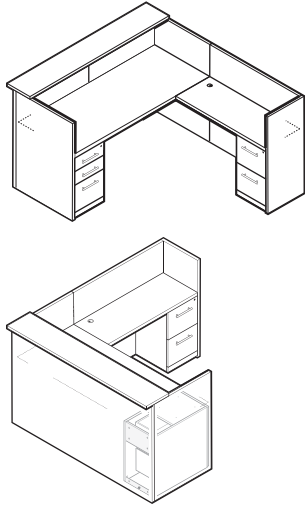

XZLR-RB  
(Right-hand shown)

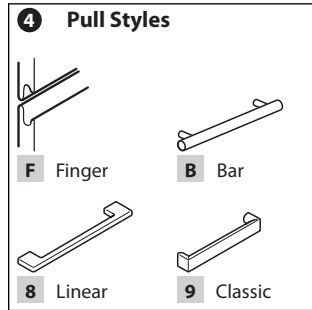

### Features

- Includes gallery enclosure with transaction shelf, two worksurfaces, two pedestals, one grommet and attachment hardware.
- 1.1875"(30mm) thick wood worksurface with a choice of profiled edge (Square, Bevel, Radius or Traditional) applied to user edge only. Double-cut veneers available with Square 3mm Radius edge only.
- Transaction shelf depth is 12"(305mm).
- Transaction shelf is 1.5"(38mm) thick with profiled edge both user and visitor sides.
- Pedestals are 15.5"(394mm) wide.
- Box drawers with one black drawer divider per drawer and one black pencil tray per pedestal.
- File drawer with integrated file hanging system:
  - Letter size front-to-back filing
  - Legal size side-to-side filing
- Box and file drawers with full extension slides.
- Drawer pull options:
  - Bar pulls available in powdercoat finish.
  - Linear and Classic pulls are available in satin nickel finish only.
- One lock standard for each pedestal.
- Lock plug is available in black or chrome.
- For lock options, refer to Lock Program section of the Accessories Price List.
- Standard with 2"(51mm) grommet oriented to connection end of return; option of black or satin chrome finish.
- Glides provide 2"(51mm) adjustment range.
- Reception shell shipped unassembled, pedestals shipped assembled ready for field installation.

### Specification Tips

- Handed design (left or right) based on orientation of return when seated at main worksurface.
- Accommodates separately specified center drawer.
- Specified edge profile is applied to both worksurface and countertop.

### To Order, Specify:

- 1) Product number, including:

#### ① Edge Option:

Wood:

- 1** Square
- 5** Bevel, add **\$349.00** list
- 6** Radius, add **\$349.00** list
- 7** Traditional, add **\$349.00** list

#### ② Storage Option:

- 56** One Box/Box/File and One File/File Black Miterfold
- ST** One Box/Box/File and One File/File Wood, add **\$293.77** list

#### ③ Orientation:

- L** Left-hand
- R** Right-hand

#### ④ Pull Option:

- F** Finger (Wood only)
- B** Bar
- 8** Linear
- 9** Classic

- 2) Finish code for lower components (paint or wood).
- 3) Trim color for bar pull (if specified).
- 4) Trim color for locks and grommet (required).



# Masters Series

## Reception Stations

Height	Depth	Width	Number	①	②	③	④	Wood Group A	Group B
<b>Wood</b>									
44.1875"(1122mm)	100.5"(2553mm)	74.25"(1886mm)	Enclosure	XZUR-A172-	SS	Y		\$12424.76	\$13730.76
	29.125"(740mm)	72"(1829mm)	Desk						
	18.125"(460mm)	48"(1219mm)	Return						
	18.125"(460mm)	72"(1829mm)	Credenza						

### U-Shaped Reception Station

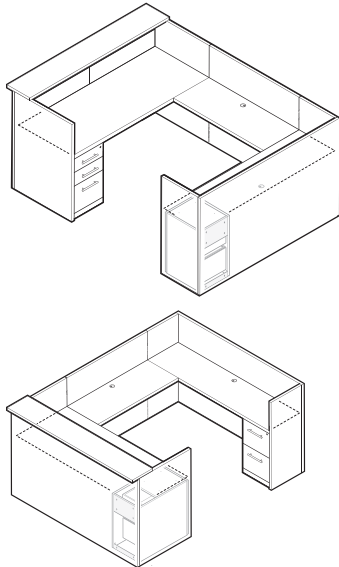

XZUR-RB  
(Right-hand shown)

### Features

- Includes gallery enclosure with transaction shelf, three worksurfaces, two pedestals, two grommets and attachment hardware.
- 1.1875"(30mm) thick wood worksurface with a choice of profiled edge (Square, Bevel, Radius or Traditional) applied to user edge only. Double-cut veneers available with Square 3mm Radius edge only.
- Transaction shelf depth is 12"(305mm).
- Transaction shelf is 1.5"(38mm) thick with profiled edge both user and visitor sides.
- Pedestals are 15.5"(394mm) wide.
- Box drawers with one black drawer divider per drawer and one black pencil tray per pedestal.
- File drawer with integrated file hanging system:
  - Letter size front-to-back filing
  - Legal size side-to-side filing
- Box and file drawers with full extension slides.
- Drawer pull options:
  - Bar pulls available in powdercoat finish.
  - Linear and Classic pulls are available in satin nickel finish only.
- One lock standard for each pedestal.
- Lock plug is available in black or chrome.
- For lock options, refer to Lock Program section of the Accessories Price List.
- Standard with 2"(51mm) grommet oriented to connection end of return; option of black or satin chrome finish.
- Glides provide 2"(51mm) adjustment range.
- Reception shell shipped unassembled, pedestals shipped assembled ready for field installation.

### To Order, Specify:

- 1) Product number, including:

#### ① Edge Option:

Wood:

- 1** Square
- 5** Bevel, add \$465.97 list
- 6** Radius, add \$465.97 list
- 7** Traditional, add \$465.97 list

#### ② Storage Option:

**56** One Box/Box/File and One File/File Black Miterfold

**ST** One Box/Box/File and One File/File Wood, add \$293.77 list

#### ③ Orientation:

- L** Left-hand
- R** Right-hand

#### ④ Pull Option:

- F** Finger (Wood only)
- B** Bar
- 8** Linear
- 9** Classic

- 2) Finish code for lower components (wood).
- 3) Laminate worksurface color (if option specified).
- 4) Laminate edge trim for worksurface (if option specified).
- 5) Trim color for bar pull (if specified).
- 6) Trim color for locks and grommet (required).

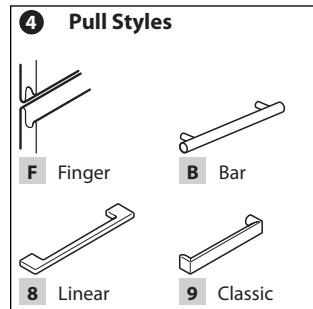

### Specification Tips

- Handed design (left or right) based on orientation of return when seated at main worksurface.
- Accommodates separately specified center drawer.
- Specified edge profile is applied to both worksurface and countertop.

### Tackboards — Reception Station L-Shaped and U-Shaped

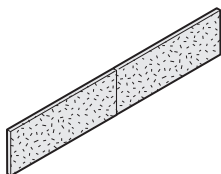

X4TR

Height	Depth	Width	Number	Fabric Grade A	B	C
12.5"(318mm)	.875"(22mm)	72"(1829mm)	X4TR-1272	\$424.31	\$485.49	\$561.85

### Features

- Includes fabric covered tackboard(s) to mount between reception desk worksurface and counter top.
- Tackboards are shipped in two equal width pieces.

### To Order, Specify:

- 1) Product number.
- 2) Fabric code.

# Masters Series

Common Storage Top — Rectangular

Depth	Width	Number <sup>①</sup>	Laminate		Wood Group A	Wood Group B		
			A	B	Edge Options 1	Edge Options 1	5,6,7	
<b>Laminate</b>								
36.125"(918mm)	60"(1524mm)	XLWT-3660-JSNN	\$709.09	\$ 755.32				
	66"(1676mm)	XLWT-3666-JSNN	738.89	787.49				
	72"(1829mm)	XLWT-3672-JSNN	768.69	819.66				
	90"(2286mm)	XLWT-3690-JSNN	858.09	916.17				
	96"(2438mm)	XLWT-3696-JSNN	887.89	948.34				
	102"(2591mm)	XLWT-36A2-JSNN	917.69	980.51				
	108"(2743mm)	XLWT-36A8-JSNN	947.49	1012.68				
<b>Wood</b>								
36.125"(918mm)	60"(1524mm)	XZWT-3660-■ SNSN			\$1655.23	\$1834.59	\$1951.56	
	66"(1676mm)	XZWT-3666-■ SNSN			1724.16	1910.99	2027.96	
	72"(1829mm)	XZWT-3672-■ SNSN			1793.09	1987.39	2104.36	
	90"(2286mm)	XZWT-3690-■ SNSN			1999.88	2216.59	2333.56	
	96"(2438mm)	XZWT-3696-■ SNSN			2068.81	2292.99	2409.96	
	102"(2591mm)	XZWT-36A2-■ SNSN			2137.74	2369.39	2486.36	
	108"(2743mm)	XZWT-36A8-■ SNSN			2206.67	2445.79	2562.76	

### Common Storage Top with Two Profiled Edges

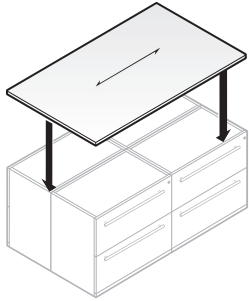

XLWT-SN  
XZWT-SN

### Features

- 1.1875"(30mm) thick laminate worksurface with 3mm edgeband applied to user and visitor edges only. Ends capped with 1mm thick edgeband.
- 1.1875"(30mm) thick wood worksurface with a choice of profiled edge (Square, Bevel, Radius or Traditional) applied to user and visitor edges. Double-cut veneers available with Square 3mm Radius edge only.
- Profiled two edges.

### Specification Tip

- For use with two back-to-back 18"(457mm) deep (ganged) 2H storage cabinets or lateral files.

### To Order, Specify:

- 1) Product number, including:

#### ① Edge Option:

Wood:

1 Square

5 Bevel

6 Radius

7 Traditional

- 2) Finish code (laminate or wood).

- 3) Laminate edge trim color (if laminate specified).

**Masters Series**

## Modular Component — Credenza Top

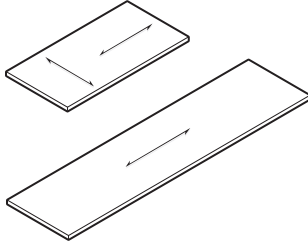
**Modular Component —  
Credenza Top**

XLWF  
XZWF

**Features**

- 1.1875"(30mm) thick laminate worktop with 3mm edgeband applied to user side, ends and visitor side capped with 1mm thick edgeband.
- 1.1875"(30mm) thick wood worktop with a choice of 3mm or profile edge to user side, ends and back capped with 1mm veneer.
- Wood worktop 30"(762mm), 36"(914mm), 42"(1067mm) and 48"(1219mm) wide available with choice of grain direction; side-to-side (standard) or front-to-back.

**Specification Tips**

- For use with other separately specified modular components such as pedestals, end panels, mid-support panels, L-supports and attached storage units to assemble modular credenza units.
- Designed to span two units.
- See Modular Components Application in Specification Guide.

**To Order, Specify:**

1) Product number, including:

**① Edge Option:**

- J** Edgeband (Laminate only)
- 1** Square (Wood only)
- 5** Bevel (Wood only)
- 6** Radius (Wood only)
- 7** Traditional (Wood only)

**② Grain Direction:**

(30", 36", 42" and 48" wide only)

- F** Front-to-back
- S** Side-to-side

2) Finish code (laminate or wood).

3) Laminate edge trim color (if laminate specified).

**Masters Series**

Modular Credenza Top — Laminate

Depth	Nominal Width	Actual Width	Number ①②	Laminate	
				A	B
19"(483mm)	30"(762mm)	30.18"(767mm)	XLWF-1930-JSNN	\$223.41	\$241.30
	36"(914mm)	36.18"(919mm)	XLWF-1936-JSNN	253.21	273.47
	42"(1067mm)	42.18"(1071mm)	XLWF-1942-JSNN	283.01	305.64
	48"(1219mm)	48.18"(1224mm)	XLWF-1948-JSNN	312.81	337.81
	54"(1372mm)	54.18"(1376mm)	XLWF-1954-JSNN	342.61	369.98
	60"(1524mm)	60.18"(1529mm)	XLWF-1960-JSNN	372.41	402.15
	66"(1676mm)	66.18"(1681mm)	XLWF-1966-JSNN	402.21	434.32
	72"(1829mm)	72.25"(1835mm)	XLWF-1972-JSNN	432.01	466.49
	78"(1981mm)	78.38"(1991mm)	XLWF-1978-JSNN	461.81	498.66
	84"(2134mm)	84.38"(2143mm)	XLWF-1984-JSNN	491.61	530.83
	90"(2286mm)	90.38"(2296mm)	XLWF-1990-JSNN	521.41	563.00
	96"(2438mm)	96.38"(2448mm)	XLWF-1996-JSNN	551.21	595.17
	102"(2591mm)	102.38"(2600mm)	XLWF-19A2-JSNN	581.01	627.34
	108"(2743mm)	108.38"(2753mm)	XLWF-19A8-JSNN	610.81	659.51
114"(2896mm)	114.38"(2905mm)	XLWF-19B4-JSNN	640.61	691.68	
120"(3048mm)	120.38"(3058mm)	XLWF-19C0-JSNN	670.41	723.85	
24"(610mm)	30"(762mm)	30.18"(767mm)	XLWF-2430-JSNN	\$283.01	\$305.75
	36"(914mm)	36.18"(919mm)	XLWF-2436-JSNN	312.81	337.92
	42"(1067mm)	42.18"(1071mm)	XLWF-2442-JSNN	342.61	370.09
	48"(1219mm)	48.18"(1224mm)	XLWF-2448-JSNN	372.41	402.26
	54"(1372mm)	54.18"(1376mm)	XLWF-2454-JSNN	402.21	434.43
	60"(1524mm)	60.18"(1529mm)	XLWF-2460-JSNN	432.01	466.60
	66"(1676mm)	66.18"(1681mm)	XLWF-2466-JSNN	461.81	498.77
	72"(1829mm)	72.25"(1835mm)	XLWF-2472-JSNN	491.61	530.94
	78"(1981mm)	78.38"(1991mm)	XLWF-2478-JSNN	521.41	563.11
	84"(2134mm)	84.38"(2143mm)	XLWF-2484-JSNN	551.21	595.28
	90"(2286mm)	90.38"(2296mm)	XLWF-2490-JSNN	581.01	627.45
	96"(2438mm)	96.38"(2448mm)	XLWF-2496-JSNN	610.81	659.62
	102"(2591mm)	102.38"(2600mm)	XLWF-24A2-JSNN	640.61	691.79
	108"(2743mm)	108.38"(2753mm)	XLWF-24A8-JSNN	670.41	723.96
114"(2896mm)	114.38"(2905mm)	XLWF-24B4-JSNN	700.21	756.13	
120"(3048mm)	120.38"(3058mm)	XLWF-24C0-JSNN	730.01	788.30	
30"(762mm)	30"(762mm)	30.18"(767mm)	XLWF-3030-JSNN	\$354.53	\$383.09
	36"(914mm)	36.18"(919mm)	XLWF-3036-JSNN	384.33	415.26
	42"(1067mm)	42.18"(1071mm)	XLWF-3042-JSNN	414.13	447.43
	48"(1219mm)	48.18"(1224mm)	XLWF-3048-JSNN	443.93	479.60
	54"(1372mm)	54.18"(1376mm)	XLWF-3054-JSNN	473.73	511.77
	60"(1524mm)	60.18"(1529mm)	XLWF-3060-JSNN	503.53	543.94
	66"(1676mm)	66.18"(1681mm)	XLWF-3066-JSNN	533.33	576.11
	72"(1829mm)	72.25"(1835mm)	XLWF-3072-JSNN	563.13	608.28
	78"(1981mm)	78.38"(1991mm)	XLWF-3078-JSNN	592.93	640.45
	84"(2134mm)	84.38"(2143mm)	XLWF-3084-JSNN	622.73	672.62
	90"(2286mm)	90.38"(2296mm)	XLWF-3090-JSNN	652.53	704.79
	96"(2438mm)	96.38"(2448mm)	XLWF-3096-JSNN	682.33	736.96
	102"(2591mm)	102.38"(2600mm)	XLWF-30A2-JSNN	712.13	769.13
	108"(2743mm)	108.38"(2753mm)	XLWF-30A8-JSNN	741.93	801.30
114"(2896mm)	114.38"(2905mm)	XLWF-30B4-JSNN	771.73	833.47	
120"(3048mm)	120.38"(3058mm)	XLWF-30C0-JSNN	801.53	865.64	

**Masters Series**

Modular Credenza Top — Wood

Depth	Width	Number ① ②	Wood Group A	Wood Group B	
			Edge Options 1	Edge Options 1	5,6,7
19"(483mm)	30"(762mm)	XZWF-1930- SN N	\$ 507.96	\$ 563.10	\$ 680.07
	36"(914mm)	XZWF-1936- SN N	576.89	639.50	756.47
	42"(1067mm)	XZWF-1942- SN N	645.82	715.90	832.87
	48"(1219mm)	XZWF-1948- SN N	714.75	792.30	909.27
	54"(1372mm)	XZWF-1954- SNSN	783.68	868.70	985.67
	60"(1524mm)	XZWF-1960- SNSN	852.61	945.10	1062.07
	66"(1676mm)	XZWF-1966- SNSN	921.54	1021.50	1138.47
	72"(1829mm)	XZWF-1972- SNSN	990.47	1097.90	1214.87
	78"(1981mm)	XZWF-1978- SNSN	1059.40	1174.30	1291.27
	84"(2134mm)	XZWF-1984- SNSN	1128.33	1250.70	1367.67
	90"(2286mm)	XZWF-1990- SNSN	1197.26	1327.10	1444.07
	96"(2438mm)	XZWF-1996- SNSN	1266.19	1403.50	1520.47
	102"(2591mm)	XZWF-19A2- SNSN	1335.12	1479.90	1596.87
	108"(2743mm)	XZWF-19A8- SNSN	1404.05	1556.30	1673.27
114"(2896mm)	XZWF-19B4- SNSN	1472.98	1632.70	1749.67	
120"(3048mm)	XZWF-19C0- SNSN	1541.91	1709.10	1826.07	
24"(610mm)	30"(762mm)	XZWF-2430- SN N	\$ 620.91	\$ 701.60	\$ 818.57
	36"(914mm)	XZWF-2436- SN N	689.84	778.00	894.97
	42"(1067mm)	XZWF-2442- SN N	758.77	854.40	971.37
	48"(1219mm)	XZWF-2448- SN N	827.70	930.80	1047.77
	54"(1372mm)	XZWF-2454- SNSN	896.63	1007.20	1124.17
	60"(1524mm)	XZWF-2460- SNSN	965.56	1083.60	1200.57
	66"(1676mm)	XZWF-2466- SNSN	1034.49	1160.00	1276.97
	72"(1829mm)	XZWF-2472- SNSN	1103.42	1236.40	1353.37
	78"(1981mm)	XZWF-2478- SNSN	1172.35	1312.80	1429.77
	84"(2134mm)	XZWF-2484- SNSN	1241.28	1389.20	1506.17
	90"(2286mm)	XZWF-2490- SNSN	1310.21	1465.60	1582.57
	96"(2438mm)	XZWF-2496- SNSN	1379.14	1542.00	1658.97
	102"(2591mm)	XZWF-24A2- SNSN	1448.07	1618.40	1735.37
	108"(2743mm)	XZWF-24A8- SNSN	1517.00	1694.80	1811.77
114"(2896mm)	XZWF-24B4- SNSN	1585.93	1771.20	1888.17	
120"(3048mm)	XZWF-24C0- SNSN	1654.86	1847.60	1964.57	
30"(762mm)	30"(762mm)	XZWF-3030- SN N	\$ 756.45	\$ 867.80	\$ 984.77
	36"(914mm)	XZWF-3036- SN N	825.38	944.20	1061.17
	42"(1067mm)	XZWF-3042- SN N	894.31	1020.60	1137.57
	48"(1219mm)	XZWF-3048- SN N	963.24	1097.00	1213.97
	54"(1372mm)	XZWF-3054- SNSN	1032.17	1173.40	1290.37
	60"(1524mm)	XZWF-3060- SNSN	1101.10	1249.80	1366.77
	66"(1676mm)	XZWF-3066- SNSN	1170.03	1326.20	1443.17
	72"(1829mm)	XZWF-3072- SNSN	1238.96	1402.60	1519.57
	78"(1981mm)	XZWF-3078- SNSN	1307.89	1479.00	1595.97
	84"(2134mm)	XZWF-3084- SNSN	1376.82	1555.40	1672.37
	90"(2286mm)	XZWF-3090- SNSN	1445.75	1631.80	1748.77
	96"(2438mm)	XZWF-3096- SNSN	1514.68	1708.20	1825.17
	102"(2591mm)	XZWF-30A2- SNSN	1583.61	1784.60	1901.57
	108"(2743mm)	XZWF-30A8- SNSN	1652.54	1861.00	1977.97
114"(2896mm)	XZWF-30B4- SNSN	1721.47	1937.40	2054.37	
120"(3048mm)	XZWF-30C0- SNSN	1790.40	2013.80	2130.77	

# Masters Series

## Modular Components — Full-Overlay Modesty Panel

Height	Width	Number <sup>①</sup>	Laminate		Wood	
			A	B	Group A	Group B
<b>Laminate</b>						
27.5"(699mm)	30"(762mm)	ULXF-2730-S	\$ 323.66	\$ 349.57		
	36"(914mm)	ULXF-2736-S	382.34	413.11		
	42"(1067mm)	ULXF-2742-S	441.02	476.65		
	48"(1219mm)	ULXF-2748-S	499.70	540.19		
	54"(1372mm)	ULXF-2754-S	558.38	603.73		
	60"(1524mm)	ULXF-2760-S	617.06	667.27		
	66"(1676mm)	ULXF-2766-S	675.74	730.81		
	72"(1829mm)	ULXF-2772-S	734.42	794.35		
	78"(1981mm)	ULXF-2778-S	793.10	857.89		
	84"(2134mm)	ULXF-2784-S	851.78	921.43		
	90"(2286mm)	ULXF-2790-S	910.46	984.97		
	96"(2438mm)	ULXF-2796-S	969.14	1048.51		
	102"(2591mm)	ULXF-27A2-S	1027.82	1112.05		
	108"(2743mm)	ULXF-27A8-S	1086.50	1175.59		
	114"(2896mm)	ULXF-27B4-S	1145.18	1239.13		
	120"(3048mm)	ULXF-27C0-S	1203.86	1302.67		
<b>Wood</b>						
27.5"(699mm)	30"(762mm)	UXXF-2730-S			\$ 610.00	\$ 678.09
	36"(914mm)	UXXF-2736-S			690.28	766.65
	42"(1067mm)	UXXF-2742-S			770.56	855.21
	48"(1219mm)	UXXF-2748-S			850.84	943.77
	54"(1372mm)	UXXF-2754-S			931.12	1032.33
	60"(1524mm)	UXXF-2760-S			1011.40	1120.89
	66"(1676mm)	UXXF-2766-S			1091.68	1209.45
	72"(1829mm)	UXXF-2772-S			1171.96	1298.01
	78"(1981mm)	UXXF-2778-S			1252.24	1386.57
	84"(2134mm)	UXXF-2784-S			1332.52	1475.13
	90"(2286mm)	UXXF-2790-S			1412.80	1563.69
	96"(2438mm)	UXXF-2796-S			1493.08	1652.25
	102"(2591mm)	UXXF-27A2-S			1573.36	1740.81
	108"(2743mm)	UXXF-27A8-S			1653.64	1829.37
	114"(2896mm)	UXXF-27B4-S			1733.92	1917.93
	120"(3048mm)	UXXF-27C0-S			1814.20	2006.49

### Full Overlay Modesty Panel

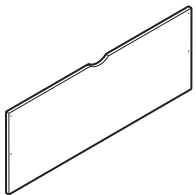

ULXF-SS  
UXXF-SS

#### Features

- Includes .75"(19mm) thick modesty panel.
- Field supplied hardware.
- Optional unfinished clearcoat wireway scallop available located at center of the top of the panel.

#### Specification Tips

- For use with separately specified modular components (worksurface and support panels) and attached storage units to assemble credenza units.
- Attachment hardware ships with storage units or end supports.
- See Modular Components Application in Specification Guide.

#### To Order, Specify:

- 1) Product number, including:

#### ① Scallop Option:

N No Scallop

S Scallop

- 2) Finish code (laminate or wood).
- 3) Laminate edge trim color (if laminate specified).

## Masters Series

Modular Components — Hinged Modesty Panel

Height	Depth	Width	Number <sup>①</sup>	Laminate		Wood Group A		Wood Group B	
				A	B	1	2	1	2
<b>Laminate</b>									
25.5"(648mm)	10.125"(257mm)	24"(610mm)	ULXH-2624-SN2	\$460.73	\$497.61				
		30"(762mm)	ULXH-2630-SN2	514.20	554.92				
		36"(914mm)	ULXH-2636-SN2	567.67	612.23				
		42"(1067mm)	ULXH-2642-SN2	621.14	669.54				
		48"(1219mm)	ULXH-2648-SN2	674.61	726.85				
		54"(1372mm)	ULXH-2654-SN2	728.08	784.16				
		60"(1524mm)	ULXH-2660-SN2	781.55	841.47				
		66"(1676mm)	ULXH-2666-SN2	835.02	898.78				
<b>Wood</b>									
25.5"(648mm)	10.125"(257mm)	24"(610mm)	UXXH-2624-SN ■			\$ 703.78	\$ 773.95	\$ 784.79	\$ 861.99
		30"(762mm)	UXXH-2630-SN ■			794.43	866.84	884.49	961.69
		36"(914mm)	UXXH-2636-SN ■			885.08	959.73	984.19	1061.39
		42"(1067mm)	UXXH-2642-SN ■			975.73	1052.62	1083.89	1161.09
		48"(1219mm)	UXXH-2648-SN ■			1066.38	1145.51	1183.59	1260.79
		54"(1372mm)	UXXH-2654-SN ■			1157.03	1238.40	1283.29	1360.49
		60"(1524mm)	UXXH-2660-SN ■			1247.68	1331.29	1382.99	1460.19
		66"(1676mm)	UXXH-2666-SN ■			1338.33	1424.18	1482.69	1559.89

## Hinged Modesty Panel

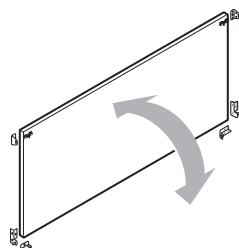

ULXH-SN2  
UXXH-SN2

## Features

- Includes .75"(19mm) thick modesty panel and attachment hardware.
- Allows for access to power or voice/data when used with other modular components to assemble modular credenza.

## Specification Tips

- No wireway scallop included.
- For use with separately specified modular components (credenza top, L-support panels, intermediate T-supports, storage units, etc.) to assemble modular credenza.

## To Order, Specify:

- 1) Product number, including:

## ① Finish Option (wood only):

- 1 Finished front
  - 2 Finished front and back
- 2) Finish code (laminate or wood).
  - 3) Laminate edge trim color (if laminate specified).

# Masters Series

## Adaptable Modesty Panel

### Adaptable Modesty Panel

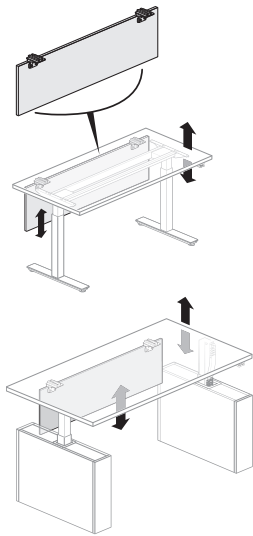

ULXS  
UXXS  
UFXS

### Features

- Includes a laminate, wood or fabric hinged modesty panel and attachment hardware.
- Modesty Panels are 11.59”(294mm) high (actual) and 0.56”(14mm) thick.
- Modesty Panels are mounted 1.4”(36mm) below the table top to allow for wire pass-through.
- Fabric surface is non-tackable.
- Modesty panel is removable; slides into table attachment brackets. No tools required.
- Screen and hardware are field installed.

### Specification Tips

- For use on Fixed Height or Height Adjustable Table Desk, Height Adjustable Credenza Desk and Fixed Height or Height Adjustable Convergent Worktop with or without shroud(s), if applicable.
- A Height Adjustable Table Desk or Credenza Desk with a pair of shrouds may be used with either an Adaptable Modesty or a Modesty Panel for Shroud or both modesty panels may be used together in a layered application:
  - The Adaptable Modesty panel is installed outboard of the Modesty Panel for Shroud.
  - The Modesty Panel for Shroud is stationary and provides modesty between the pair of shrouds.
  - The Adaptable Modesty Panel is attached to the underside of the desk and provides height adjustable modesty when the desk is raised or lowered.

### Specification Tips, (cont'd):

- A Height Adjustable Convergent Worktop with or without a single shroud may be used with only an Adaptable Modesty Panel:
  - The Adaptable Modesty panel is installed between the shroud or T-Leg and front of the 1.5H Attached Lower Storage Unit.
  - The Adaptable Modesty Panel is attached to the underside of the desk and provides height adjustable modesty when the desk is raised or lowered.
  - When the Table Desk is raised to full height a 9”(229mm) gap between panels.

### To Order, Specify:

- 1) Product number.
- 2) Laminate, wood or fabric color.
- 3) Edge trim color (laminate only).

### Adaptable Modesty Panel Application Widths

TABLE DESK WIDTH	TABLE DESKS HEIGHT ADJUSTABLE		FIXED HEIGHT
	Shroud Pair	No Shroud	Hoop Base
60”(1524mm)	39”	54”	54”
66”(1676mm)	45”	60”	60”
72”(1829mm)	51”	66”	66”
78”(1981mm)	57”	72”	72”
84”(2134mm)	63”	78”	78”

CONVERGENT WORKTOP WIDTH	FLOATING CONVERGENT WORKTOP / STORAGE SUPPORTED APPLICATION											
	Column Support						Hoop Leg Support					
	19” DEEP STORAGE			24” DEEP STORAGE			19” DEEP STORAGE			24” DEEP STORAGE		
	Rectangle Top	Wedge Square Top	Wedge Radius Top	Rectangle Top	Wedge Square Top	Wedge Radius Top	Rectangle Top	Wedge Square Top	Wedge Radius Top	Rectangle Top	Wedge Square Top	Wedge Radius Top
58”(1473mm)	36”	36”	36”	30”	30”	30”	36”	36”	36”	30”	30”	30”
64”(1626mm)	42”	42”	42”	36”	36”	36”	42”	42”	42”	36”	36”	36”
70”(1778mm)	48”	48”	48”	42”	42”	42”	48”	48”	48”	42”	42”	42”
76”(1930mm)	54”	54”	54”	48”	48”	48”	54”	54”	54”	48”	48”	48”
82”(2083mm)	60”	60”	60”	54”	54”	54”	60”	60”	60”	54”	54”	54”

TABLE DESK WIDTH	HEIGHT ADJUSTABLE CONVERGENT WORKTOP / CONCEALED LEG IN STORAGE APPLICATION											
	19” DEEP STORAGE						24” DEEP STORAGE					
	SHROUD			NO SHROUD			SHROUD			NO SHROUD		
	Rectangle Top	Wedge Square Top	Wedge Radius Top	Rectangle Top	Wedge Square Top	Wedge Radius Top	Rectangle Top	Wedge Square Top	Wedge Radius Top	Rectangle Top	Wedge Square Top	Wedge Radius Top
58”(1473mm)	30”	30”	27”	36”	36”	33”	24”	24”	21”	30”	30”	27”
64”(1626mm)	36”	36”	33”	42”	42”	39”	30”	30”	27”	36”	36”	33”
70”(1778mm)	42”	42”	39”	48”	48”	45”	36”	36”	33”	42”	42”	39”
76”(1930mm)	48”	48”	45”	54”	54”	51”	42”	42”	39”	48”	48”	45”
82”(2083mm)	54”	54”	51”	60”	60”	57”	48”	48”	45”	54”	54”	51”



# Masters Series

## Adaptable Modesty Panel

Height	Width	Number	Laminate		Wood Number	Wood Group A	Wood Group B
			A	B			
13"(330mm)	21"(533mm)	ULXS-1321	\$177.12	\$192.27	UXXS-1321	\$ 486.18	\$ 550.07
	24"(610mm)	ULXS-1324	193.69	212.03	UXXS-1324	518.99	588.73
	27"(686mm)	ULXS-1327	210.26	229.93	UXXS-1327	551.80	627.39
	30"(762mm)	ULXS-1330	226.83	249.69	UXXS-1330	584.61	666.05
	36"(914mm)	ULXS-1336	259.97	287.35	UXXS-1336	650.23	743.37
	39"(991mm)	ULXS-1339	276.54	305.25	UXXS-1339	683.04	782.03
	42"(1067mm)	ULXS-1342	293.11	325.01	UXXS-1342	715.85	820.69
	45"(1143mm)	ULXS-1345	309.68	342.91	UXXS-1345	748.66	859.35
	48"(1219mm)	ULXS-1348	326.25	362.67	UXXS-1348	781.47	898.01
	51"(1295mm)	ULXS-1351	342.82	380.57	UXXS-1351	814.28	936.67
	54"(1372mm)	ULXS-1354	359.39	400.33	UXXS-1354	847.09	975.33
	57"(1448mm)	ULXS-1357	375.96	418.23	UXXS-1357	879.90	1013.99
	60"(1524mm)	ULXS-1360	392.53	437.99	UXXS-1360	912.71	1052.65
	63"(1600mm)	ULXS-1363	409.10	455.89	UXXS-1363	945.52	1091.31
	66"(1676mm)	ULXS-1366	425.67	475.65	UXXS-1366	978.33	1129.97
	69"(1753mm)	ULXS-1369	442.24	493.55	UXXS-1369	1011.14	1168.63
	72"(1829mm)	ULXS-1372	458.81	513.31	UXXS-1372	1043.95	1207.29
	75"(1905mm)	ULXS-1375	475.38	531.21	UXXS-1375	1076.76	1245.95
	78"(1981mm)	ULXS-1378	491.95	550.97	UXXS-1378	1109.57	1284.61

Height	Width	Number	Fabric Grade						
			A	B	C	D	E	F	G
13"(330mm)	21"(533mm)	UFXS-1321	\$276.84	\$287.21	\$298.62	\$311.04	\$323.49	\$340.08	\$350.43
	24"(610mm)	UFXS-1324	303.94	314.31	325.72	338.14	350.59	367.18	377.53
	27"(686mm)	UFXS-1327	331.04	341.41	352.82	365.24	377.69	394.28	404.63
	30"(762mm)	UFXS-1330	358.14	368.51	379.92	392.34	404.79	421.38	431.73
	33"(838mm)	UFXS-1333	385.24	395.61	407.02	419.44	431.89	448.48	458.83
	36"(914mm)	UFXS-1336	412.34	422.71	434.12	446.54	458.99	475.58	485.93
	39"(991mm)	UFXS-1339	439.44	449.81	461.22	473.64	486.09	502.68	513.03
	42"(1067mm)	UFXS-1342	466.54	476.91	488.32	500.74	513.19	529.78	540.13
	45"(1143mm)	UFXS-1345	493.64	504.01	515.42	527.84	540.29	556.88	567.23
	48"(1219mm)	UFXS-1348	520.74	531.11	542.52	554.94	567.39	583.98	594.33
	51"(1295mm)	UFXS-1351	547.84	558.21	569.62	582.04	594.49	611.08	621.43
	54"(1372mm)	UFXS-1354	574.94	585.31	596.72	609.14	621.59	638.18	648.53
	57"(1448mm)	UFXS-1357	602.04	612.41	623.82	636.24	648.69	665.28	675.63
	60"(1524mm)	UFXS-1360	629.14	639.51	650.92	663.34	675.79	692.38	702.73
	63"(1600mm)	UFXS-1363	656.24	666.61	678.02	690.44	702.89	719.48	729.83
	66"(1676mm)	UFXS-1366	683.34	693.71	705.12	717.54	729.99	746.58	756.93
	69"(1753mm)	UFXS-1369	710.44	720.81	732.22	744.64	757.09	773.68	784.03
	72"(1829mm)	UFXS-1372	737.54	747.91	759.32	771.74	784.19	800.78	811.13
	75"(1905mm)	UFXS-1375	764.64	775.01	786.42	798.84	811.29	827.88	838.23
	78"(1981mm)	UFXS-1378	791.74	802.11	813.52	825.94	838.39	854.98	865.33

# Masters Series

## Modular Components — End Panel — 2H

Height	Depth	Number <sup>①</sup>	Laminate		Wood	
			A	B	Group A	Group B
<b>Laminate — Full Overlay Modesty Panel Application</b>						
28"(711mm)	18.25"(464mm)	ULSE-2818-S █ M	\$332.03	\$358.59		
	23.25"(591mm)	ULSE-2823-S █ M	348.78	376.74		
	29.25"(743mm)	ULSE-2829-S █ M	368.88	398.52		
<b>Laminate — No Modesty Panel Application</b>						
28"(711mm)	19"(483mm)	ULSE-2819-S █ N	\$332.03	\$358.59		
	24"(610mm)	ULSE-2824-S █ N	348.78	376.74		
	30"(762mm)	ULSE-2830-S █ N	368.88	398.52		
<b>Wood — Full Overlay Modesty Panel Application</b>						
28"(711mm)	18.25"(464mm)	UXSE-2818-S █ M			\$529.09	\$539.52
	23.25"(591mm)	UXSE-2823-S █ M			569.34	581.22
	29.25"(743mm)	UXSE-2829-S █ M			617.64	631.26
<b>Wood — No Modesty Panel Application</b>						
28"(711mm)	19"(483mm)	UXSE-2819-S █ N			\$529.09	\$539.52
	24"(610mm)	UXSE-2824-S █ N			569.34	581.22
	30"(762mm)	UXSE-2830-S █ N			617.64	631.26

### Modular Components — End Panel — 2H

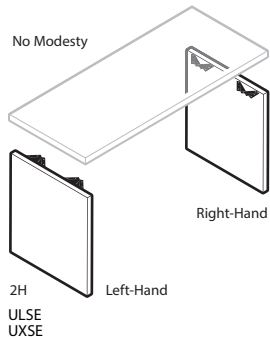
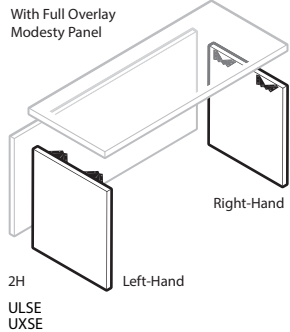

#### Features

- Includes 1.125"(29mm) thick support panel, glides and attachment hardware.
- Option of 19"(483mm), 24"(610mm) and 30"(762mm) full depth for use without modesty panel.
- Option of 18.25"(464mm), 23.25"(591mm) or 29.25"(743mm) for use with full overlay modesty panel.
- Provides full support for one end of equal depth worksurface.
- Glides provide 2"(51mm) adjustment range.

#### Specification Tips

- For use with other separately specified modular components, (credenza modular, worksurfaces, mid-support panels and modesty panels) to assemble modular shells and credenzas.
- If used to assemble a shell; the shell will not support 2H storage units.
- See Modular Components Application in Specification Guide.

#### To Order, Specify:

- 1) Product number, including:
  - ① Orientation:**
    - L** Left-hand
    - R** Right-hand
- 2) Finish code (laminate or wood).
- 3) Laminate edge trim color (if laminate specified).

This page intentionally blank

# Masters Series

## Modular Components — L-Support Panel

### Modular Components — L-Support Panel

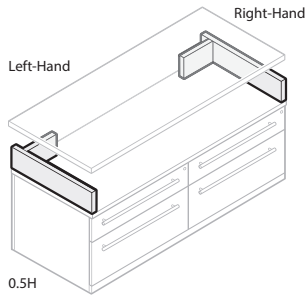

0.5H

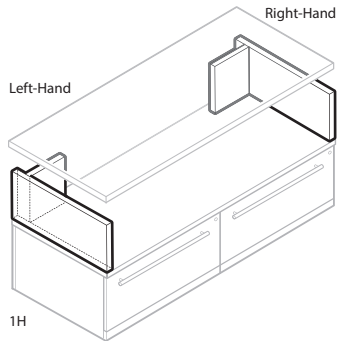

1H

XLGS  
XZGS

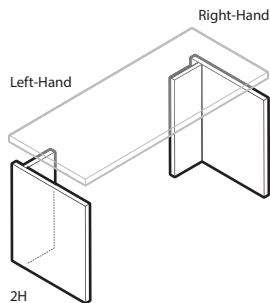

2H

ULSL  
UXSL

### Features

- Includes 1.125"(29mm) thick full depth end panel, 10"(254mm) wide support panel, glides (only 2H) and attachment hardware.
- Includes 1.125"(29mm) thick full depth end panel, 14"(356mm) wide support panel and attachment hardware.
- Option of 19"(483mm), 24"(610mm) and 30"(762mm) deep full end panel to provide full support at one end of worksurface.
- Provides full support for one end of equal depth top.
- 2H L-support includes glides with 2"(51mm) adjustment range.
- 30"(762mm) depth available in 2H only.
- Designed to be used with hinged modesty panel.

### Specification Tips

- For use with other separately specified modular components (worksurfaces and mid-support panels) and attached storage units to assemble credenza units.
- Not designed for use with full overlay modesty panel.
- Wing leg inset from the back of the slab legs 4.1875"(106mm).
- Not recommended for use next to an attached storage unit on the inner face due to bracket interference.
- 6H L-Support panel for use with 1.5H modular storage unit(s).
- 12H L-Support panel for use with 1H modular storage unit(s).
- See Applications in Specification Guide.

### To Order, Specify:

- 1) Product number, including:

#### ① Orientation:

**L** Left-hand

**R** Right-hand

- 2) Finish code (laminate or wood).
- 3) Laminate edge trim color (if laminate specified).

**Masters Series**

Modular Components — L-Support Panel

Height	Actual Overall Depth	Actual Width	Number ①	Laminate A	B	Wood Group A	Group B
<b>Laminate — 0.5H</b>							
6"(152mm)	18.88"(480mm)	10.06"(256mm)	XLGS-0619-S	<b>\$323.91</b>	<b>\$418.14</b>		
	23.88"(607mm)		XLGS-0624-S	<b>342.51</b>	<b>476.64</b>		
<b>Laminate — 1H</b>							
11.56"(294mm)	18.88"(480mm)	10.06"(256mm)	XLGS-1219-S	<b>\$359.67</b>	<b>\$469.29</b>		
	23.88"(607mm)	10.06"(256mm)	XLGS-1224-S	<b>378.27</b>	<b>527.79</b>		
<b>Laminate — 2H</b>							
28"(711mm)	18.88"(480mm)	10.06"(256mm)	ULSL-2819-S	<b>\$455.03</b>	<b>\$605.69</b>		
	23.88"(607mm)	10.06"(256mm)	ULSL-2824-S	<b>473.63</b>	<b>664.19</b>		
	29.88"(759mm)	10.06"(256mm)	ULSL-2830-S	<b>495.95</b>	<b>734.39</b>		
<b>Wood — 0.5H</b>							
6"(152mm)	18.88"(480mm)	10.06"(256mm)	XZGS-0619-S			<b>\$507.90</b>	<b>\$566.75</b>
	23.88"(607mm)		XZGS-0624-S			<b>539.80</b>	<b>602.15</b>
<b>Wood — 1H</b>							
11.56"(294mm)	18.88"(480mm)	10.06"(256mm)	XZGS-1219-S			<b>\$570.36</b>	<b>\$630.77</b>
	23.88"(607mm)	10.06"(256mm)	XZGS-1224-S			<b>602.26</b>	<b>666.17</b>
<b>Wood — 2H</b>							
28"(711mm)	18.88"(480mm)	10.06"(256mm)	UXSL-2819-S			<b>\$736.92</b>	<b>\$801.49</b>
	23.88"(607mm)	10.06"(256mm)	UXSL-2824-S			<b>768.82</b>	<b>836.89</b>
	29.88"(759mm)	10.06"(256mm)	UXSL-2830-S			<b>807.10</b>	<b>879.37</b>

# Masters Series

## Modular Components — Partial Depth L-Support Panel — 2H

Height	Actual Overall Depth	Actual Width	Number <sup>①</sup>	Laminate A	B	Wood Group A	Group B
<b>Laminate</b>							
28"(711mm)	10.06"(256mm)	10"(254mm)	ULSL-2810-S	\$421.55	\$500.39		
<b>Wood</b>							
28"(711mm)	10.06"(256mm)	10"(254mm)	UXSL-2810-S			\$679.50	\$737.77

### Modular Components — Partial Depth L-Support Panel — 2H

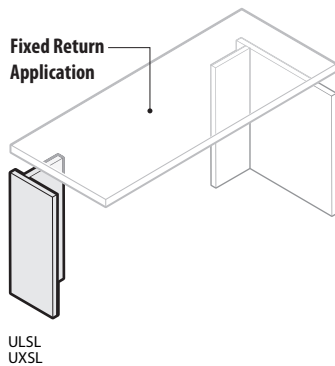
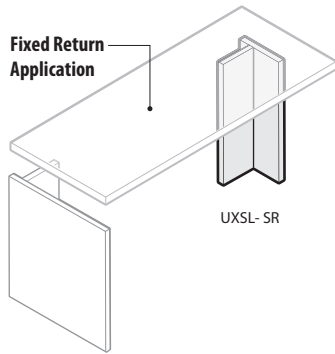
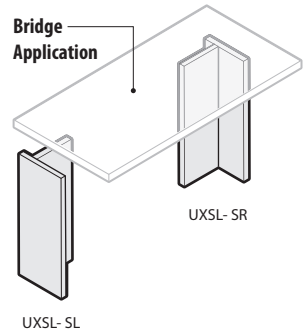

#### Features

- Includes 1.125"(29mm) thick 10.125"(257mm) deep end panel, 9"(229mm) wide support panel, glides and attachment hardware.
- Designed to be used with a hinged modesty panel.
- Glides provide 2"(51mm) adjustment range.

#### Specification Tips

- For use with other separately specified modular components (worksurface, pedestals, mid-support panels and modesty panels) to assemble modular bridge or return.
- Not designed for use with full overlay modesty panel.
- Wing leg inset from the back of the slab legs 4.1875"(106mm).
- Not recommended for use next to an attached storage unit on the inner face due to bracket interference.
- See Modular Components Application in Specification Guide.
- A single partial depth L-support panel may not be used for knee swing application.
- Two partial depth L-support panels may not be used to configure a freestanding desk or credenza shell. Use the full depth L-support panel for this application.

#### To Order, Specify:

- 1) Product number, including:

#### ① Orientation:

- L** Left-hand
- R** Right-hand

- 2) Finish code (laminate or wood).

- 3) Laminate edge trim color (if laminate specified).

## Masters Series

## Modular Components — T-Support Panel

Height	Actual Overall Depth	Actual Width	Number	Laminate		Wood	
				A	B	Group A	Group B
<b>Laminate — 0.5H</b>							
6"(152mm)	18.88"(480mm)	15.06"(383mm)	XLFS-0619-SN	\$406.58	\$500.81		
	23.88"(607mm)		XLFS-0624-SN	425.18	559.31		
	29.88"(759mm)		XLFS-0630-SN	447.50	629.51		
	35.88"(911mm)		XLFS-0636-SN	469.82	699.71		
<b>Laminate — 1H</b>							
11.56"(294mm)	18.88"(480mm)	15.06"(383mm)	XLFS-1219-SN	\$442.34	\$551.96		
	23.88"(607mm)		XLFS-1224-SN	460.94	610.46		
	29.88"(759mm)		XLFS-1230-SN	483.26	680.66		
	35.88"(911mm)		XLFS-1236-SN	505.58	750.86		
<b>Wood — 0.5H</b>							
6"(152mm)	18.88"(480mm)	15.06"(383mm)	XZFS-0619-SN			\$590.57	\$649.42
	23.88"(607mm)		XZFS-0624-SN			622.47	684.82
	29.88"(759mm)		XZFS-0630-SN			660.75	727.30
	35.88"(911mm)		XZFS-0636-SN			699.03	769.78
<b>Wood — 1H</b>							
11.56"(294mm)	18.88"(480mm)	15.06"(383mm)	XZFS-1219-SN			\$653.03	\$713.44
	23.88"(607mm)		XZFS-1224-SN			684.93	748.84
	29.88"(759mm)		XZFS-1230-SN			723.21	791.32
	35.88"(911mm)		XZFS-1236-SN			761.49	833.80

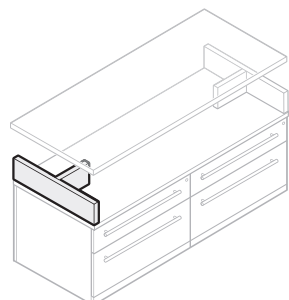
**Modular Components —  
T-Support Panel**

(0.5H)

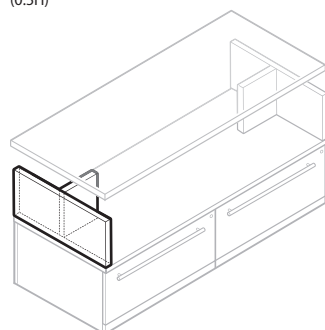
(1H)  
XLFS-SN  
XZFS-SN
**Features**

- Includes 1.125"(29mm) thick and optional width back panel, 14"(356mm) wing panel and attachment hardware.
- Provides full support for one end of equal depth worksurface.
- All sides finished; top and bottom edges are not finished.

**Specification Tips**

- For use with other separately specified modular components.
- Stacked on top of modular storage credenza to provide support for separately specified modular credenza top.
- 6H T-Support panel for use with 1.5H modular storage unit(s).
- 12H T-Support panel for use with 1H modular storage unit(s).
- See Applications in Specification Guide.

**To Order, Specify:**

- 1) Product number.
- 2) Finish code (laminate or wood).
- 3) Laminate edge trim color (if laminate specified).

# Masters Series

## Modular Components

Height	Actual Overall Depth	Actual Width	Number	Laminate		Wood	
				A	B	Group A	Group B
<b>Laminate</b>							
28"(711mm)	10.06"(256mm)	10"(254mm)	ULSX-2811-SN	\$293.09	\$312.68		
<b>Wood</b>							
28"(711mm)	10.06"(256mm)	10"(254mm)	UXSX-2811-SN			\$443.06	\$493.07

### Modular Components — T-Support Panel — 2H

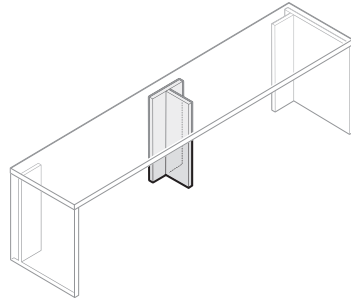

ULSX-SN  
UXSX-SN

#### Features

- Includes 1.125"(29mm) thick and 10.125"(257mm) wide back panel, 10.125"(257mm) wing panel, glides and attachment hardware.
- Glides provide 2"(51mm) adjustment range.

#### Specification Tips

- For use with other separately specified modular components (worksurfaces, pedestals and hinged modesty panels) to assemble modular credenzas.
- Not for use with full overlay modesty panel.
- Provides intermediate support for worksurfaces with spans of 60"(1524mm) or greater of unsupported width and for use with hinged modesty panels.
- See Modular Components Application in Specification Guide.

#### To Order, Specify:

- 1) Product number.
- 2) Finish code (laminate or wood).
- 3) Laminate edge trim color (if laminate specified).

<b>Laminate</b>							
28"(711mm)	10"(254mm)	10"(254mm)	ULSS-2810-S	\$272.62	\$351.46		
	14.88"(378mm)		ULSS-2814-S	287.50	398.26		
<b>Wood</b>							
28"(711mm)	10"(254mm)	10"(254mm)	UXSS-2810-S			\$530.57	\$588.84
	14.88"(378mm)		UXSS-2814-S			556.09	617.16

### Modular Components — Mid-Support Panel — 2H

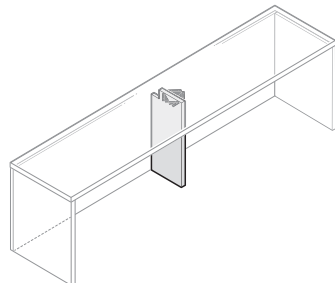

ULSS-S  
UXSS-S

#### Features

- Includes 1.125"(29mm) thick end panel, glides and attachment hardware.
- Glides provide 2"(51mm) adjustment range.

#### Specification Tips

- For use with other separately specified modular components (worksurfaces, end panels and L-support panels) and attached storage units to assemble credenza units.
- Used to provide support when unsupported span of worksurface is 60"(1524mm) or greater.
- 10.125"(257mm) mid-support panel recommended for use under worksurfaces 19"(483mm) and 24"(610mm) deep.
- 14"(356mm) mid-support panel recommended for use under worksurfaces 30"(762mm) deep and greater.
- 2" x 2"(51mm x 51mm) wireway notch located at top edge one side of support panel.
- See Modular Components Application in Specification Guide.

#### To Order, Specify:

- 1) Product number.
- 2) Finish code (laminate or wood).
- 3) Laminate edge trim color (if laminate specified).



## Masters Series

Attached Pedestals

Height	Open Back Depth	Full Back Depth	Width	Number ① ② ③	Laminate A	B	Wood Group A	Group B
<b>Laminate — Letter Width</b>								
28"(711mm)	18"(457mm)	18.75"(476mm)	15.5"(394mm)	X5PA-2818-■ ■ SS ■ L	\$1477.71	\$1662.05		
	23"(584mm)	23.75"(603mm)		X5PA-2823-■ ■ SS ■ L	1524.91	1709.25		
	29"(737mm)	29.75"(756mm)		X5PA-2829-■ ■ SS ■ L	1581.55	1765.89		
<b>Laminate — Legal Width</b>								
28"(711mm)	18"(457mm)	18.75"(476mm)	18.75"(476mm)	X5PA-2818-■ ■ SS ■ L	\$1743.34	\$1927.68		
	23"(584mm)	23.75"(603mm)		X5PA-2823-■ ■ SS ■ L	1790.54	1974.88		
<b>Wood — Letter Width</b>								
28"(711mm)	18"(457mm)	18.75"(476mm)	15.5"(394mm)	X4PA-2818-■ ■ SS ■ W			\$2119.37	\$2359.75
	23"(584mm)	23.75"(603mm)		X4PA-2823-■ ■ SS ■ W			2166.57	2412.05
	29"(737mm)	29.75"(756mm)		X4PA-2829-■ ■ SS ■ W			2223.21	2474.81
<b>Wood — Legal Width</b>								
28"(711mm)	18"(457mm)	18.75"(476mm)	18.75"(476mm)	X4PA-2818-■ ■ SS ■ W			\$2385.00	\$2653.65
	23"(584mm)	23.75"(603mm)		X4PA-2823-■ ■ SS ■ W			2432.20	2705.95

## Attached Pedestals

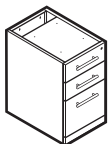
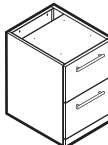
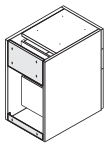
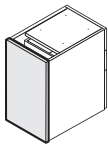
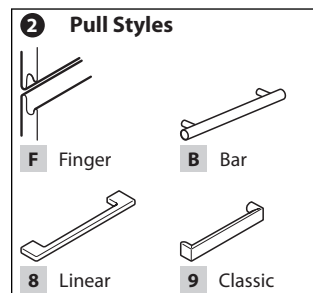
X4PA-NW  
X5PA-NLX4PA-NW  
X5PA-NLX4PA-NW  
X5PA-NLX4PA-YW  
X5PA-YL

## Features

- Includes case, unfinished top, optional full finished back, .75"(19mm) thick end panels and attachment hardware.
- Unfinished tops of pedestals 21"(533mm) and deeper include a 3"(76mm) or greater horizontal wireway gap.
- Factory installed full back option adds .75"(19mm) to the overall pedestal depth.
- Choice of letter width 15.5"(394mm) or legal width 18.75"(476mm) pedestal.
- Box drawer with one black drawer divider per drawer and one black pencil tray per pedestal.
- File drawer with an integrated file hanging system.
- Drawer pull options:
  - Bar pulls available in standard powdercoat finishes.
  - Linear and Classic available in brushed nickel finish only.
  - Finger pull option available with Wood Group B finishes.
- Box and file drawers have full extension slides.
- One lock standard per pedestal.
- Lock plug is available in black or chrome.
- For lock options, refer to Lock Program section of the Accessories Price List.
- Glides provide 2"(51mm) adjustment range.
- Shipped assembled.

## Specification Tips

- 18"(457mm) and 18.75"(476mm) deep pedestals for use under 19"(483mm) deep worksurfaces.
- 23"(584mm) and 23.75"(603mm) deep pedestals for use under 24"(610mm) deep worksurfaces.
- 29"(737mm) and 29.75"(756mm) deep pedestals for use under 30"(762mm) deep worksurfaces.
- Non-handed design, allows for pedestal to be installed left or right on site.
- Can be utilized with a pre-configured return; no back option must be specified.

## To Order, Specify:

1) Product number, including:

## ① Pedestal Drawer Option:

Letter Width (18", 23" and 29" depths)

- 5 Box/Box/File Black Miterfold
  - S Box/Box/File Wood, add \$127.29 list
  - 6 File/File Black Miterfold
  - T File/File Wood, add \$127.29 list
- Legal Width (18" and 23" depths)
- 8 Box/Box/File Black Miterfold
  - L Box/Box/File Wood, add \$133.03 list
  - 9 File/File Black Miterfold
  - M File/File Wood, add \$133.03 list

## ② Drawer Pull Option:

- F Finger (Wood only)
- B Bar
- 8 Linear
- 9 Classic

## ③ Back Option:

- N No Back
- Y Finished Laminate Back, add \$273.32 list  
Finished Wood Back, add \$354.70 list

- 2) Finish code (laminate or wood).
- 3) Laminate edge trim color (if laminate specified).
- 4) Trim color for bar pull (if specified).
- 5) Trim color for lock (required).

# Masters Series

## Mobile Pedestals

Height	Depth	Width	Number ①②	Laminate		Wood	
				A	B	Group A	Group B
<b>Laminate</b>							
21.5"(546mm)	21"(533mm)	15.5"(394mm)	X5PM-2221-■ ■ SSBL	\$1676.69	\$1861.03		
<b>Wood</b>							
21.5"(546mm)	21"(533mm)	15.5"(394mm)	X4PM-2221-■ ■ SSBW			\$2389.65	\$2633.09

### Mobile Pedestal

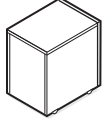
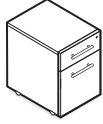

X4PM-BW  
X7PM-BW

### Features

- Includes case, finished top, finished back and casters.
- Box drawer with one black drawer divider per drawer and one black pencil tray per pedestal.
- File drawer with an integrated file hanging system.
- Drawer pull options:
  - Bar pulls available in powdercoat finishes.
  - Linear and Classic pulls are available in satin nickel finish only.
  - Finger pull option available with Wood Group B finishes.
- Box and file drawers have full extension slides.
- One lock standard per pedestal.
- Lock plug is available in black or chrome.
- For lock options, refer to Lock Program section of the Accessories Price List.
- Casters: four black swivel with front two locking.
- Shipped assembled; casters field installed.

### Specification Tip

- Not designed to fit flush under a 19"(483mm) deep worksurface.

### To Order, Specify:

- 1) Product number, including:

#### ① Pedestal Drawer Option:

**4** Box/File Black Miterfold

**R** Box/File Wood, add \$127.29 list

#### ② Drawer Pull Option:

**F** Finger (Wood only)

**B** Bar

**8** Linear

**9** Classic

- 2) Finish code (laminite or wood).
- 3) Laminate edge trim color (if laminate specified).
- 4) Trim color for bar pull (if specified).
- 5) Trim color for lock (required).

### ② Pull Styles

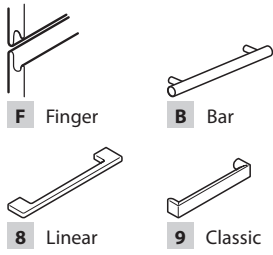

## Masters Series

	Actual Height	Nominal Depth	Actual Width	For Use With	Number	Fabric Grade					
						A	B	C	D	E	
<b>Storage Cushion</b>  XZSC-2116-FA	1.25" (32mm)	21" (533mm)	15.5" (394mm)	Mobile Pedestal	XZSC-2116-FA	\$376.99	\$409.04	\$413.76	\$418.78	\$423.80	
		19" (483mm)	30" (762mm)	1.5H or 2H Lower Storage	XZSC-1930-FA	458.89	502.64	519.06	542.80	561.86	
			36" (914mm)		XZSC-1936-FA	498.79	548.24	570.36	603.22	629.12	
			42" (1067mm)		XZSC-1942-FA	538.69	593.84	621.66	663.64	696.38	
		1.25" (39mm)	24" (610mm)	30" (762mm)	1.5H or 2H Lower Storage	XZSC-2430-FA	\$511.39	\$562.64	\$586.56	\$622.30	\$650.36
			36" (914mm)		XZSC-2436-FA	561.79	620.24	651.36	698.62	735.32	
			42" (1067mm)		XZSC-2442-FA	612.19	677.84	716.16	774.94	820.28	

**Feature**

- Includes one cushion with removable attachment.

**Specification Tips**

- Lower Storage Cushion must be used with a separately specified Credenza Top.
- Lower Storage Cushion may be used with lower storage units with no back or finished back option.
- Mobile Pedestal includes a finished top; pedestal cushion is used directly on pedestal top.
- Not for use with X or V Series lower storage.
- Cushion is full depth; plan accordingly when used between upper and lower storage with a tackboard.

**To Order, Specify:**

- Product number.
- Fabric finish.

# Masters Series

## 1.5H Attached Lateral File with Open Shelf

Height	Open Back Depth	Finished Back Depth	Width	Number	①	②	③	Laminate A	B	Wood Group A	Group B
<b>Laminate</b>											
21.5"(546mm)	18"(457mm)	18.75"(476mm)	30"(762mm)	X5FV-1830-N	■	■	SS LL	\$1483.30	\$1710.40		
			36"(914mm)	X5FV-1836-N	■	■	SS LL	1676.65	1903.75		
	23"(584mm)	23.75"(603mm)	30"(762mm)	X5FV-2330-N	■	■	SS LL	\$1600.26	\$1827.36		
			36"(914mm)	X5FV-2336-N	■	■	SS LL	1793.61	2020.71		
<b>Wood</b>											
21.5"(546mm)	18"(457mm)	18.75"(476mm)	30"(762mm)	X4FV-1830-N	■	■	SS LW			\$2239.49	\$2505.65
			36"(914mm)	X4FV-1836-N	■	■	SS LW			2488.72	2783.57
	23"(584mm)	23.75"(603mm)	30"(762mm)	X4FV-2330-N	■	■	SS LW			\$2356.45	\$2636.56
			36"(914mm)	X4FV-2336-N	■	■	SS LW			2605.68	2914.48

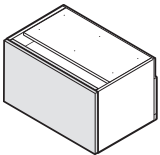
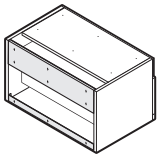
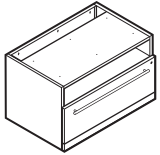

X4FV-LW  
X5FV-LW

### Features

- Includes unfinished top, optional full finished back, adjustable shelf for 2H unit, glides and attachment hardware.
- Unfinished top for 23"(584mm) depth storage unit includes a 5"(127mm) horizontal wireway gap. The 18" depth storage unit has no gap.
- Drawer pull options:
  - Bar pulls available in powdercoat finishes.
  - Linear and Classic pulls are available in satin nickel finish only.
  - Finger pull option available with Wood Group B finishes.
- Adjustable shelf depth for 2H sized to allow .5"(13mm) wireway at the rear of the cabinet.
- One .75"(19mm) thick adjustable shelf for 2H has ±1.25"(32mm) adjustment range.
- Factory installed full back option adds .75"(19mm) to the overall storage cabinet depth.
- Glides provide 2"(51mm) adjustment range.
- Shipped assembled.

### Specification Tips

- Storage cabinet used as support for upper storage requires either a finished back or overlay modesty panel.
- 18"(457mm) and 18.75"(476mm) deep storage cabinets for use under 19"(483mm) deep worksurfaces.
- 23"(584mm) and 23.75"(603mm) deep storage cabinets for use under 24"(610mm) deep worksurfaces.
- Separately specified credenza top may be added to attached storage cabinet with finished back option for use as freestanding unit.

### To Order, Specify:

- 1) Product number, including:

#### ① File Drawer Option:

- S** Black Miterfold
- W** Wood, add \$136.85 list

#### ② Drawer Pull Option:

- F** Finger (Wood only)
- B** Bar
- 8** Linear
- 9** Classic

#### ③ Back Option:

- N** No Back
- Y** Finished Back, add \$366.42 list

- 2) Finish code (laminated or wood).
- 3) Laminate edge trim color (if laminate specified).
- 4) Trim color for bar pull (if specified).
- 5) Trim color for lock (required).

This page intentionally blank

# Masters Series

## Attached Lateral Files

### 1H and 1.5H High and 2H Attached Lateral Files

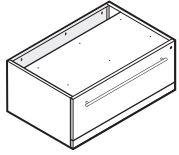

X4F1-LW  
X5F1-LL  
(Front view)

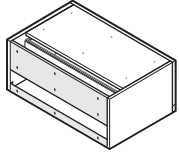

X4F1-LW  
X5F1-LL  
(Back view)

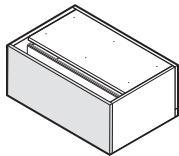

X4F1-LW  
X5F1-LL  
(Back view)

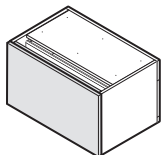
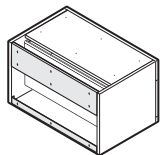
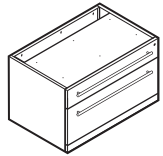

X4FB-LW  
X5FB-LL

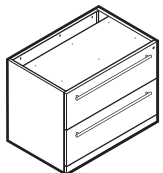

X4FA-LW  
X5FA-LL  
(Front view)

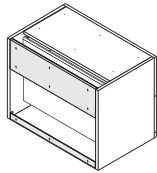

X4FA-LW  
X5FA-LL  
(Back view)

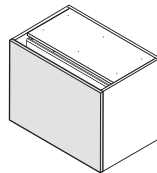

X4FA-LW  
X5FA-LL  
(Back view)

### Features

- Includes case, unfinished top, optional full finished back, .75" (19mm) thick end panels, glides and attachment hardware.
- Unfinished top of lateral file includes a 3" (76mm) horizontal wireway gap.
- Factory installed finished back option adds .75" (19mm) to the overall lateral file depth.
- File drawer with an integrated file hanging system.
- Two file hanging bars included per file drawer.
- File drawers have full extension slides with integrated anti-tip interlock feature.
- Drawer pull options:
  - Bar pulls available in powdercoat finishes.
  - Linear and Classic pulls are available in satin nickel finish only.
  - Finger pull option available with Wood Group B finishes.
- One lock standard per lateral file; includes dual lock bar system.
- Lock plug is available in black or chrome.
- For lock options, refer to Lock Program section of the Accessories Price List.
- Glides provide 2" (51mm) adjustment range.
- 42" (1067mm) width files available in laminate and wood only.
- Shipped assembled.

### Specification Tips

- 18" (457mm) and 18.75" (476mm) deep lateral files for use under 19" (483mm) deep worksurfaces.
- 23" (584mm) and 23.75" (603mm) deep lateral files for use under 24" (610mm) deep worksurfaces.
- 2H lateral files can be incorporated into a preconfigured return with a pedestal. No back option must be specified.
- See Planning Modular Components in Specification Guide for details.

### To Order, Specify:

1) Product number, including:

#### 1 File Drawer Option:

- S** Black Miterfold
- W** Wood  
1H, add **\$89.92** list  
1.5H, add **\$136.85** list  
2H, add **\$181.80** list

#### 2 Drawer Pull Option:

- F** Finger (Wood only)
- B** Bar
- 8** Linear
- 9** Classic

#### 3 Back Option:

- N** No Back
- Y** Finished Back  
1H, add **\$353.98** list  
1.5H, add **\$366.42** list  
2H, add **\$377.34** list

- 2) Finish code (laminate or wood).
- 3) Laminate edge trim color (if laminate specified).
- 4) Trim color for bar pull (if specified).
- 5) Trim color for lock (required).

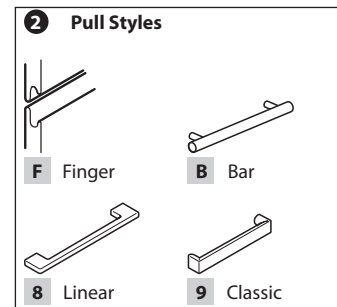

## Masters Series

Attached Lateral Files

Height	Open Back Depth	Full Back Depth	Width	Number	①	②	③	Laminate A	B	Wood Group A	Group B
<b>Laminate — 1H</b>											
15.1875"(386mm)	18"(457mm)	18.75"(476mm)	30"(762mm)	X5F1-1830-N	■	■	SS	■	LL	\$1332.66	\$1547.72
			36"(914mm)	X5F1-1836-N	■	■	SS	■	LL	1526.01	1741.07
			42"(1067mm)	X5F1-1842-N	■	■	SS	■	LL	1719.36	1934.42
23"(584mm)	23.75"(603mm)	30"(762mm)	X5F1-2330-N	■	■	SS	■	LL	\$1449.62	\$1664.68	
			36"(914mm)	X5F1-2336-N	■	■	SS	■	LL	1642.97	1858.03
			42"(1067mm)	X5F1-2342-N	■	■	SS	■	LL	1836.32	2051.38
<b>Laminate — 1.5H</b>											
21.5"(546mm)	18"(457mm)	18.75"(476mm)	30"(762mm)	X5FB-1830-N	■	■	SS	■	LL	\$1483.30	\$1710.40
			36"(914mm)	X5FB-1836-N	■	■	SS	■	LL	1676.65	1903.75
			42"(1067mm)	X5FB-1842-N	■	■	SS	■	LL	1870.00	2097.10
23"(584mm)	23.75"(603mm)	30"(762mm)	X5FB-2330-N	■	■	SS	■	LL	\$1600.26	\$1827.36	
			36"(914mm)	X5FB-2336-N	■	■	SS	■	LL	1793.61	2020.71
			42"(1067mm)	X5FB-2342-N	■	■	SS	■	LL	1986.96	2214.06
<b>Laminate — 2H</b>											
28"(711mm)	18"(457mm)	18.75"(476mm)	30"(762mm)	X5FA-1830-N	■	■	SS	■	LL	\$1715.79	\$1961.49
			36"(914mm)	X5FA-1836-N	■	■	SS	■	LL	1909.14	2154.84
			42"(1067mm)	X5FA-1842-N	■	■	SS	■	LL	2102.49	2348.19
23"(584mm)	23.75"(603mm)	30"(762mm)	X5FA-2330-N	■	■	SS	■	LL	\$1832.75	\$2078.45	
			36"(914mm)	X5FA-2336-N	■	■	SS	■	LL	2026.10	2271.80
			42"(1067mm)	X5FA-2342-N	■	■	SS	■	LL	2219.45	2465.15
<b>Wood — 1H</b>											
15.1875"(386mm)	18"(457mm)	18.75"(476mm)	30"(762mm)	X4F1-1830-N	■	■	SS	■	LW	\$1969.67	\$2195.29
			36"(914mm)	X4F1-1836-N	■	■	SS	■	LW	2218.90	2473.21
			42"(1067mm)	X4F1-1842-N	■	■	SS	■	LW	2468.13	2751.13
23"(584mm)	23.75"(603mm)	30"(762mm)	X4F1-2330-N	■	■	SS	■	LW	\$2086.63	\$2326.20	
			36"(914mm)	X4F1-2336-N	■	■	SS	■	LW	2335.86	2604.12
			42"(1067mm)	X4F1-2342-N	■	■	SS	■	LW	2585.09	2882.04
<b>Wood — 1.5H</b>											
21.5"(546mm)	18"(457mm)	18.75"(476mm)	30"(762mm)	X4FB-1830-N	■	■	SS	■	LW	\$2386.11	\$2652.27
			36"(914mm)	X4FB-1836-N	■	■	SS	■	LW	2635.34	2930.19
			42"(1067mm)	X4FB-1842-N	■	■	SS	■	LW	2884.57	3208.11
23"(584mm)	23.75"(603mm)	30"(762mm)	X4FB-2330-N	■	■	SS	■	LW	\$2503.07	\$2783.18	
			36"(914mm)	X4FB-2336-N	■	■	SS	■	LW	2752.30	3061.10
			42"(1067mm)	X4FB-2342-N	■	■	SS	■	LW	3001.53	3339.02
<b>Wood — 2H</b>											
28"(711mm)	18"(457mm)	18.75"(476mm)	30"(762mm)	X4FA-1830-N	■	■	SS	■	LW	\$2655.23	\$2937.29
			36"(914mm)	X4FA-1836-N	■	■	SS	■	LW	2904.46	3215.21
			42"(1067mm)	X4FA-1842-N	■	■	SS	■	LW	3153.69	3493.13
23"(584mm)	23.75"(603mm)	30"(762mm)	X4FA-2330-N	■	■	SS	■	LW	\$2772.19	\$3068.20	
			36"(914mm)	X4FA-2336-N	■	■	SS	■	LW	3021.42	3346.12
			42"(1067mm)	X4FA-2342-N	■	■	SS	■	LW	3270.65	3624.04

# Masters Series

## Attached Storage Units

### 1H and 2H Attached Storage Units

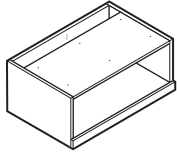

X4N1-NN  
X5N1-NN  
(Front view)

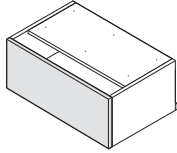

X4N1-NN  
X5N1-NN  
(Back view)

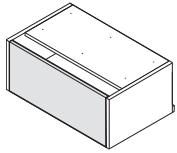

X4N1-NN  
X5N1-NN  
(Back view)

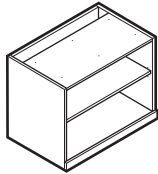

X4N2-NN  
X5N2-NN  
(Front view)

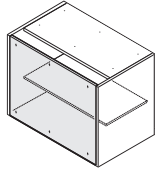

X4N2-NN  
X5N2-NN  
(Back view)

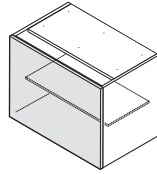

X4N2-NN  
X5N2-NN  
(Back view)

### Features

- Includes unfinished top, optional full finished back, adjustable shelf for 2H unit, glides and attachment hardware.
- Unfinished top for 23"(584mm) depth storage unit includes a 5"(127mm) horizontal wireway gap. The 18" depth storage unit has no gap.
- Adjustable shelf depth for 2H sized to allow .5"(13mm) wireway at the rear of the cabinet.
- One .75"(19mm) thick adjustable shelf for 2H has  $\pm 1.25$ "(32mm) adjustment range.
- Proud Back Finished option adds .75"(19mm) to the overall storage cabinet depth.
- Glides provide 2"(51mm) adjustment range.
- 42"(1067mm) width available in laminate and wood, and has fixed shelves.
- Shipped assembled.

### Specification Tips

- Storage unit used as support for upper storage requires either a finished back or overlay modesty panel.
- 18"(457mm) and 18.75"(476mm) deep storage units for use under 19"(483mm) deep worksurfaces.
- 23"(584mm) and 23.75"(603mm) deep storage units for use under 24"(610mm) deep worksurfaces.
- Separately specified credenza top may be added to attached storage unit with finished back option for use as freestanding unit.

### To Order, Specify:

- 1) Product number, including:

#### ① Back Option:

- N** Inset Back Unfinished
- L** Proud Back Finished Laminate  
1H, add **\$353.98** list  
1.5H, add **\$366.42** list  
2H, add **\$344.16** list
- W** Proud Back Finished Wood  
1H, add **\$353.98** list  
1.5H, add **\$366.42** list  
2H, add **\$410.87** list

- 2) Finish code (laminate or wood).
- 3) Laminate edge trim color (if laminate specified).



## Masters Series

Attached Storage Units

Height	Open Back Depth	Finished Back Depth	Width	Number ①	Laminate A	B	Wood Group A	Group B
<b>Laminate — 1H</b>								
15.1875"(386mm)	18"(457mm)	18.75"(476mm)	30"(762mm)	X5N1-1830-NS	■	NN	\$1160.24	\$1325.57
			36"(914mm)	X5N1-1836-NS	■	NN	1239.23	1404.56
			42"(1067mm)	X5N1-1842-NS	■	NN	1318.22	1483.55
23"(584mm)	23.75"(603mm)	30"(762mm)	X5N1-2330-NS	■	NN	\$1245.54	\$1410.87	
			X5N1-2336-NS	■	NN	1324.53	1489.86	
			X5N1-2342-NS	■	NN	1403.52	1568.85	
<b>Laminate — 1.5H</b>								
21.5"(546mm)	18"(457mm)	18.75"(476mm)	30"(762mm)	X5NB-1830-NS	■	NN	\$1477.52	\$1519.72
			36"(914mm)	X5NB-1836-NS	■	NN	1566.51	1598.71
			42"(1067mm)	X5NB-1842-NS	■	NN	1655.50	1677.70
23"(584mm)	23.75"(603mm)	30"(762mm)	X5NB-2330-NS	■	NN	\$1562.82	\$1605.02	
			X5NB-2336-NS	■	NN	1651.81	1684.01	
			X5NB-2342-NS	■	NN	1740.80	1763.00	
<b>Laminate — 2H</b>								
28"(711mm)	18"(457mm)	18.75"(476mm)	30"(762mm)	X5N2-1830-NS	■	NN	\$1461.61	\$1589.23
			36"(914mm)	X5N2-1836-NS	■	NN	1567.46	1695.08
			42"(1067mm)	X5N2-1842-NS	■	NN	1673.31	1800.93
23"(584mm)	23.75"(603mm)	30"(762mm)	X5N2-2330-NS	■	NN	\$1565.87	\$1693.49	
			X5N2-2336-NS	■	NN	1671.72	1799.34	
			X5N2-2342-NS	■	NN	1777.57	1905.19	
<b>Wood — 1H</b>								
15.1875"(386mm)	18"(457mm)	18.75"(476mm)	30"(762mm)	X4N1-1830-NS	■	NN	\$2028.75	\$2254.58
			36"(914mm)	X4N1-1836-NS	■	NN	2173.10	2415.03
			42"(1067mm)	X4N1-1842-NS	■	NN	2317.45	2575.48
23"(584mm)	23.75"(603mm)	30"(762mm)	X4N1-2330-NS	■	NN	\$2188.77	\$2432.37	
			X4N1-2336-NS	■	NN	2333.12	2592.82	
			X4N1-2342-NS	■	NN	2477.47	2753.27	
<b>Wood — 1.5H</b>								
21.5"(546mm)	18"(457mm)	18.75"(476mm)	30"(762mm)	X4NB-1830-NS	■	NN	\$2244.11	\$2471.46
			36"(914mm)	X4NB-1836-NS	■	NN	2390.45	2621.81
			42"(1067mm)	X4NB-1842-NS	■	NN	2536.79	2772.16
23"(584mm)	23.75"(603mm)	30"(762mm)	X4NB-2330-NS	■	NN	\$2329.41	\$2556.76	
			X4NB-2336-NS	■	NN	2475.75	2707.11	
			X4NB-2342-NS	■	NN	2622.09	2857.46	
<b>Wood — 2H</b>								
28"(711mm)	18"(457mm)	18.75"(476mm)	30"(762mm)	X4N2-1830-NS	■	NN	\$2295.33	\$2552.48
			36"(914mm)	X4N2-1836-NS	■	NN	2401.18	2658.33
			42"(1067mm)	X4N2-1842-NS	■	NN	2507.03	2764.18
23"(584mm)	23.75"(603mm)	30"(762mm)	X4N2-2330-NS	■	NN	\$2399.59	\$2656.74	
			X4N2-2336-NS	■	NN	2505.44	2762.59	
			X4N2-2342-NS	■	NN	2611.29	2868.44	

# Masters Series

1.5H Attached Storage for use with Convergent Worktop — Open Unit

Depth	Width	Number	Laminate		Wood Group	
			A	B	A	B
<b>Laminate — No back</b>						
18"(457mm)	30"(762mm)	X5PB-1830-NSNN	\$1310.92	\$1353.12	N/A	N/A
	36"(914mm)	X5PB-1836-NSNN	1399.91	1432.11	N/A	N/A
	42"(1067mm)	X5PB-1842-NSNN	1488.90	1511.10	N/A	N/A
23"(584mm)	30"(762mm)	X5PB-2330-NSNN	\$1409.17	\$1451.37	N/A	N/A
	36"(914mm)	X5PB-2336-NSNN	1498.16	1530.36	N/A	N/A
	42"(1067mm)	X5PB-2342-NSNN	1587.15	1609.35	N/A	N/A
<b>Wood — No back</b>						
18"(457mm)	30"(762mm)	X4PB-1830-NSNN	N/A	N/A	\$2184.25	\$2411.76
	36"(914mm)	X4PB-1836-NSNN	N/A	N/A	2330.59	2562.11
	42"(1067mm)	X4PB-1842-NSNN	N/A	N/A	2476.93	2712.46
23"(584mm)	30"(762mm)	X4PB-2330-NSNN	N/A	N/A	\$2282.50	\$2510.01
	36"(914mm)	X4PB-2336-NSNN	N/A	N/A	2428.84	2660.36
	42"(1067mm)	X4PB-2342-NSNN	N/A	N/A	2575.18	2810.71
<b>Laminate — With back</b>						
18"(457mm)	30"(762mm)	X5PB-1830-NSLN	\$1677.37	\$1719.57	N/A	N/A
	36"(914mm)	X5PB-1836-NSLN	1766.36	1798.56	N/A	N/A
	42"(1067mm)	X5PB-1842-NSLN	1855.35	1877.55	N/A	N/A
23"(584mm)	30"(762mm)	X5PB-2330-NSLN	\$1775.62	\$1817.82	N/A	N/A
	36"(914mm)	X5PB-2336-NSLN	1864.61	1896.81	N/A	N/A
	42"(1067mm)	X5PB-2342-NSLN	1953.60	1975.80	N/A	N/A
<b>Wood — With back</b>						
18"(457mm)	30"(762mm)	X4PB-1830-NSWN	N/A	N/A	\$2550.70	\$2778.21
	36"(914mm)	X4PB-1836-NSWN	N/A	N/A	2697.04	2928.56
	42"(1067mm)	X4PB-1842-NSWN	N/A	N/A	2843.38	3078.91
23"(584mm)	30"(762mm)	X4PB-2330-NSWN	N/A	N/A	\$2648.95	\$2876.46
	36"(914mm)	X4PB-2336-NSWN	N/A	N/A	2795.29	3026.81
	42"(1067mm)	X4PB-2342-NSWN	N/A	N/A	2941.63	3177.16

## 1.5H Attached Storage for use with Convergent Worktop — Open Unit

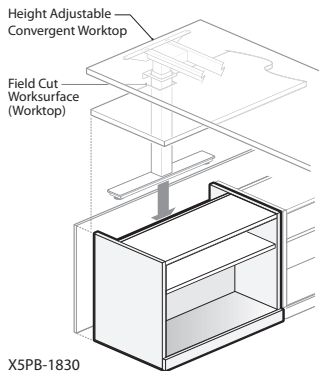

### Feature

- Includes case with optional finished back panel, 5"(127mm) deep full height wire way and adjustable shelf.

### Specification Tips

- Attached lower storage units are used to design a modular storage credenza.
- Designed to be attached to adjacent modular lower storage for stability.
- Back of storage unit has a 5"(127mm) deep full height open wireway intended to conceal a height adjustable T-Leg included with a Height Adjustable Convergent Worktop.
- May be used to support a Convergent Worktop - For use with 1.5H Storage (fixed height convergent worktop with stanchion).
- Requires a separately specified Credenza Top.
- The optional finished back panel is .75"(19mm) thick and will increase the overall depth of the attached storage unit.

### To Order, Specify:

#### No Back

- Product number.
- Laminate surface color or wood finish for case.
- Edge trim color (laminate only).

#### With Finished Back

- Product number.
- Laminate surface color or wood finish for case and back.
- Edge trim color (laminate only).

# Masters Series

## Attached Storage Units

Height	Inner Back Depth	Finished Back Depth	Width	Number ① ② ③	Laminate A	B	Wood Group A	Group B
<b>Laminate</b>								
28"(711mm)	18"(457mm)	18.75"(476mm)	30"(762mm)	X5H2-1830- S ■ ■ L	<b>\$1758.49</b>	<b>\$1899.15</b>		
			36"(914mm)	X5H2-1836- S ■ ■ L	<b>1856.44</b>	<b>1997.10</b>		
	23"(584mm)	23.75"(603mm)	30"(762mm)	X5H2-2330- S ■ ■ L	<b>\$1851.70</b>	<b>\$1992.36</b>		
			36"(914mm)	X5H2-2336- S ■ ■ L	<b>1949.65</b>	<b>2090.31</b>		
<b>Wood</b>								
28"(711mm)	18"(457mm)	18.75"(476mm)	30"(762mm)	X4H2-1830- S ■ ■ W			<b>\$2684.42</b>	<b>\$2993.43</b>
			36"(914mm)	X4H2-1836- S ■ ■ W			<b>2789.99</b>	<b>3111.25</b>
	23"(584mm)	23.75"(603mm)	30"(762mm)	X4H2-2330- S ■ ■ W			<b>\$2798.62</b>	<b>\$3120.62</b>
			36"(914mm)	X4H2-2336- S ■ ■ W			<b>2904.19</b>	<b>3238.44</b>

### 2H Storage Unit with Doors

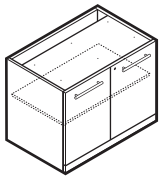

X4H2-LW  
X5H2-LL  
(Front view)

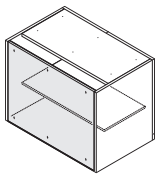

X4H2-LW  
X5H2-LL  
(Back view)

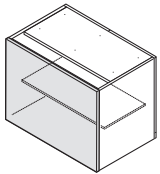

X4H2-LW  
X5H2-LL  
(Back view)

### Features

- Includes case, unfinished top, optional full finished back, adjustable shelf, doors with concealed hinges, glides, and attachment hardware.
- Unfinished top for 23"(584mm) depth storage unit includes a 5"(127mm) horizontal wireway gap. The 18" depth storage unit has no gap.
- One .75"(19mm) thick adjustable shelf has ±1.25"(32mm) adjustment range.
- Adjustable shelf depth sized to allow .5"(13mm) wireway at the rear of the cabinet.
- Factory installed finished wood back option adds .75"(19mm) to the overall storage cabinet depth.
- Door pull options:
  - Finger pull option indicates door with touch latch.
  - Bar pulls available in powdercoat finishes.
  - Linear and Classic pulls are available in satin nickel finish only.
- Optional lock available; lock plug available in black or chrome.
- For lock options, refer to Lock Program section of the Accessories Price List.
- Glides provide 2"(51mm) adjustment range.
- Shipped assembled.

### Specification Tips

- 18"(457mm) and 18.75"(476mm) deep storage units for use under 19"(483mm) deep worksurfaces.
- 23"(584mm) and 23.75"(603mm) deep storage units for use under 24"(610mm) deep worksurfaces.
- Separately specified worksurface may be added to attached storage unit with finished back option for use as freestanding 2H.

### To Order, Specify:

- 1) Product number, including:

#### ① Door Pull Option:

- F** Finger (Touch latch)
- B** Bar
- 8** Linear
- 9** Classic

#### ② Back Option:

- N** No Finished Back
- L** Finished Laminate Back, add **\$323.89** list
- W** Finished Wood Back, add **\$396.29** list

#### ③ Lock Option:

- N** No Lock
- L** Lock, add **\$169.05** list

- 2) Finish code (laminate or wood).
- 3) Laminate edge trim color (if laminate specified).
- 4) Trim color for bar pull (if specified).
- 5) Trim color for lock (if specified).

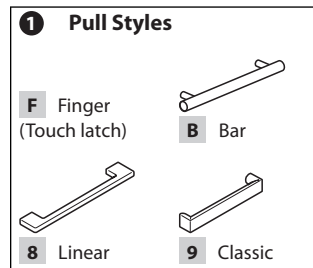

# Masters Series

## 1.5H Attached Sliding Door Storage Unit

### 1.5H Attached Sliding Door Storage Unit

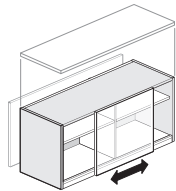

48" - 72" W  
(1 Sliding Doors)

X5SB-1848  
X45B-1848

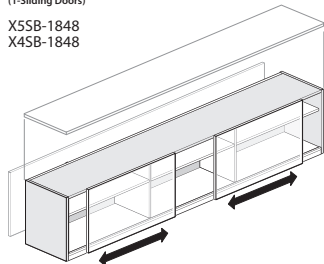

78" - 108" W  
(2 Sliding Doors)

X5SB-1848  
X45B-1848

### Feature

- Includes case with optional back panel , non-locking sliding door(s) and adjustable shelf.

### Specification Tips

- May be used as a stand alone unit.
- May be used adjacent to applicable attached lower storage or modular components to design a credenza storage unit.
- Not for use with a Height Adjustable Convergent Worktop.
- May be used to support a Convergent Worktop - For use with 1.5H Storage (fixed height convergent worktop with stanchion).
- Requires a separately specified Credenza Top.
- The optional finished back panel is .75"(19mm) thick and will increase the overall depth of the attached storage unit.

### To Order, Specify:

#### No Back

- 1) Product number.
- 2) Laminate surface color or wood finish for case and door.
- 3) Edge trim color (laminated only).

#### With Finished Back

- 1) Product number.
- 2) Laminate surface color or wood finish for case, back and door.
- 3) Edge trim color (laminated only).

## Masters Series

## 1.5H Attached Sliding Door Storage Unit

Depth	Width	Number	Number of Door(s) and Divider(s)	Shelf(s)	Laminate A	B	Wood Group A	Wood Group B
<b>Laminate Door — No back</b>								
18"(457mm)	48"(1219mm)	X5SB-1848-NSNNL	1	2	\$2430.01	\$2435.37	N/A	N/A
	54"(1372mm)	X5SB-1854-NSNNL	1	2	2563.19	2579.22	N/A	N/A
	60"(1524mm)	X5SB-1860-NSNNL	1	2	2696.37	2723.07	N/A	N/A
	66"(1676mm)	X5SB-1866-NSNNL	1	2	2829.55	2866.92	N/A	N/A
	72"(1829mm)	X5SB-1872-NSNNL	1	2	2962.73	3010.77	N/A	N/A
	78"(1981mm)	X5SB-1878-NSNNL	2	3	3095.91	3154.62	N/A	N/A
	84"(2134mm)	X5SB-1884-NSNNL	2	3	3229.09	3298.47	N/A	N/A
	90"(2286mm)	X5SB-1890-NSNNL	2	3	3362.27	3442.32	N/A	N/A
	96"(2438mm)	X5SB-1896-NSNNL	2	3	3495.45	3586.17	N/A	N/A
	102"(2591mm)	X5SB-18A2-NSNNL	2	3	3628.63	3730.02	N/A	N/A
	108"(2743mm)	X5SB-18A8-NSNNL	2	3	3761.81	3873.87	N/A	N/A
<b>Wood Door — No back</b>								
18"(457mm)	48"(1219mm)	X4SB-1848-NSNNW	1	2	N/A	N/A	\$3199.10	\$4115.32
	54"(1372mm)	X4SB-1854-NSNNW	1	2	N/A	N/A	3431.85	4362.06
	60"(1524mm)	X4SB-1860-NSNNW	1	2	N/A	N/A	3664.60	4608.80
	66"(1676mm)	X4SB-1866-NSNNW	1	2	N/A	N/A	3897.35	4855.54
	72"(1829mm)	X4SB-1872-NSNNW	1	2	N/A	N/A	4130.10	5102.28
	78"(1981mm)	X4SB-1878-NSNNW	2	3	N/A	N/A	4362.85	5349.02
	84"(2134mm)	X4SB-1884-NSNNW	2	3	N/A	N/A	4595.60	5595.76
	90"(2286mm)	X4SB-1890-NSNNW	2	3	N/A	N/A	4828.35	5842.50
	96"(2438mm)	X4SB-1896-NSNNW	2	3	N/A	N/A	5061.10	6089.24
	102"(2591mm)	X4SB-18A2-NSNNW	2	3	N/A	N/A	5293.85	6335.98
	108"(2743mm)	X4SB-18A8-NSNNW	2	3	N/A	N/A	5526.60	6582.72
<b>Laminate Door — With Finished Back</b>								
18"(457mm)	48"(1219mm)	X5SB-1848-NSLNL	1	2	\$2793.43	\$2798.79	N/A	N/A
	54"(1372mm)	X5SB-1854-NSLNL	1	2	2926.61	2942.64	N/A	N/A
	60"(1524mm)	X5SB-1860-NSLNL	1	2	3059.79	3086.49	N/A	N/A
	66"(1676mm)	X5SB-1866-NSLNL	1	2	3192.97	3230.34	N/A	N/A
	72"(1829mm)	X5SB-1872-NSLNL	1	2	3326.15	3374.19	N/A	N/A
	78"(1981mm)	X5SB-1878-NSLNL	2	3	3459.33	3518.04	N/A	N/A
	84"(2134mm)	X5SB-1884-NSLNL	2	3	3592.51	3661.89	N/A	N/A
	90"(2286mm)	X5SB-1890-NSLNL	2	3	3725.69	3805.74	N/A	N/A
	96"(2438mm)	X5SB-1896-NSLNL	2	3	3858.87	3949.59	N/A	N/A
	102"(2591mm)	X5SB-18A2-NSLNL	2	3	3992.05	4093.44	N/A	N/A
	108"(2743mm)	X5SB-18A8-NSLNL	2	3	4125.23	4237.29	N/A	N/A
<b>Wood Door — With Finished back</b>								
18"(457mm)	48"(1219mm)	X4SB-1848-NSWNNW	1	2	N/A	N/A	\$3803.41	\$4719.63
	54"(1372mm)	X4SB-1854-NSWNNW	1	2	N/A	N/A	4036.16	4966.37
	60"(1524mm)	X4SB-1860-NSWNNW	1	2	N/A	N/A	4268.91	5213.11
	66"(1676mm)	X4SB-1866-NSWNNW	1	2	N/A	N/A	4501.66	5459.85
	72"(1829mm)	X4SB-1872-NSWNNW	1	2	N/A	N/A	4734.41	5706.59
	78"(1981mm)	X4SB-1878-NSWNNW	2	3	N/A	N/A	4967.16	5953.33
	84"(2134mm)	X4SB-1884-NSWNNW	2	3	N/A	N/A	5199.91	6200.07
	90"(2286mm)	X4SB-1890-NSWNNW	2	3	N/A	N/A	5432.66	6446.81
	96"(2438mm)	X4SB-1896-NSWNNW	2	3	N/A	N/A	5665.41	6693.55
	102"(2591mm)	X4SB-18A2-NSWNNW	2	3	N/A	N/A	5898.16	6940.29
	108"(2743mm)	X4SB-18A8-NSWNNW	2	3	N/A	N/A	6130.91	7187.03

# Masters Series

## 2H Attached Sliding Door Storage Unit

### 2H Attached Sliding Door Storage Unit

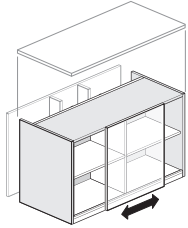

48" - 72"W  
(1 Sliding Doors)

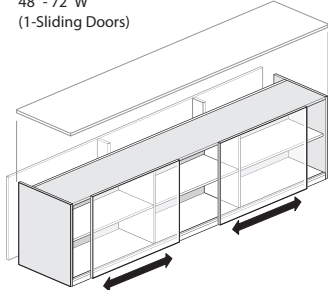

78" - 108"W  
(2 Sliding Doors)

X5CA-2348  
X4CA-2348

### Feature

- Includes case with optional finished back panel, non-locking sliding door, 5"(127mm) deep full height wire way and adjustable shelf.

### Specification Tips

- May be used as a stand alone unit.
- May be used adjacent to applicable attached lower storage or modular components to design a credenza storage unit.
- Not for use with a Convergent Worktop.
- Requires a separately specified Credenza Top
- The optional finished back panel is .75"(19mm) thick and will increase the overall depth of the attached storage unit.

### To Order, Specify:

#### No Back

- 1) Product number.
- 2) Laminate surface color or wood finish for case and door.
- 3) Edge trim color (laminated only).

#### With Finished Back

- 1) Product number.
- 2) Laminate surface color or wood finish for case, back and door.
- 3) Edge trim color (laminated only).

## Masters Series

## 2H Attached Sliding Door Storage Unit

Depth	Width	Number	Number of Door(s) and Divider(s)	Shelf(s)	Laminate A	B	Wood Group A	Wood Group B
<b>Laminate Door — No back</b>								
23"(584mm)	48"(1219mm)	X5CA-2348-NSNNL	1	2	\$2738.76	\$2763.73	N/A	N/A
	54"(1372mm)	X5CA-2354-NSNNL	1	2	2883.26	2919.80	N/A	N/A
	60"(1524mm)	X5CA-2360-NSNNL	1	2	3027.76	3075.87	N/A	N/A
	66"(1676mm)	X5CA-2366-NSNNL	1	2	3172.26	3231.94	N/A	N/A
	72"(1829mm)	X5CA-2372-NSNNL	1	2	3316.76	3388.01	N/A	N/A
	78"(1981mm)	X5CA-2378-NSNNL	2	3	3461.26	3544.08	N/A	N/A
	84"(2134mm)	X5CA-2384-NSNNL	2	3	3605.76	3700.15	N/A	N/A
	90"(2286mm)	X5CA-2390-NSNNL	2	3	3750.26	3856.22	N/A	N/A
	96"(2438mm)	X5CA-2396-NSNNL	2	3	3894.76	4012.29	N/A	N/A
	102"(2591mm)	X5CA-23A2-NSNNL	2	3	4039.26	4168.36	N/A	N/A
	108"(2743mm)	X5CA-23A8-NSNNL	2	3	4183.76	4324.43	N/A	N/A
<b>Wood Door — No back</b>								
23"(584mm)	48"(1219mm)	X4CA-2348-NSNNW	1	2	N/A	N/A	\$4023.02	\$5018.26
	54"(1372mm)	X4CA-2354-NSNNW	1	2	N/A	N/A	4275.56	5285.96
	60"(1524mm)	X4CA-2360-NSNNW	1	2	N/A	N/A	4528.10	5553.66
	66"(1676mm)	X4CA-2366-NSNNW	1	2	N/A	N/A	4780.64	5821.36
	72"(1829mm)	X4CA-2372-NSNNW	1	2	N/A	N/A	5033.18	6089.06
	78"(1981mm)	X4CA-2378-NSNNW	2	3	N/A	N/A	5285.72	6356.76
	84"(2134mm)	X4CA-2384-NSNNW	2	3	N/A	N/A	5538.26	6624.46
	90"(2286mm)	X4CA-2390-NSNNW	2	3	N/A	N/A	5790.80	6892.16
	96"(2438mm)	X4CA-2396-NSNNW	2	3	N/A	N/A	6043.34	7159.86
	102"(2591mm)	X4CA-23A2-NSNNW	2	3	N/A	N/A	6295.88	7427.56
	108"(2743mm)	X4CA-23A8-NSNNW	2	3	N/A	N/A	6548.42	7695.26
<b>Laminate Door — With Finished Back</b>								
23"(584mm)	48"(1219mm)	X5CA-2348-NSLNL	1	2	\$3133.06	\$3158.03	N/A	N/A
	54"(1372mm)	X5CA-2354-NSLNL	1	2	3277.56	3314.10	N/A	N/A
	60"(1524mm)	X5CA-2360-NSLNL	1	2	3422.06	3470.17	N/A	N/A
	66"(1676mm)	X5CA-2366-NSLNL	1	2	3566.56	3626.24	N/A	N/A
	72"(1829mm)	X5CA-2372-NSLNL	1	2	3711.06	3782.31	N/A	N/A
	78"(1981mm)	X5CA-2378-NSLNL	2	3	3855.56	3938.38	N/A	N/A
	84"(2134mm)	X5CA-2384-NSLNL	2	3	4000.06	4094.45	N/A	N/A
	90"(2286mm)	X5CA-2390-NSLNL	2	3	4144.56	4250.52	N/A	N/A
	96"(2438mm)	X5CA-2396-NSLNL	2	3	4289.06	4406.59	N/A	N/A
	102"(2591mm)	X5CA-23A2-NSLNL	2	3	4433.56	4562.66	N/A	N/A
	108"(2743mm)	X5CA-23A8-NSLNL	2	3	4578.06	4718.73	N/A	N/A
<b>Wood Door — With Finished back</b>								
23"(584mm)	48"(1219mm)	X4CA-2348-NSWNNW	1	2	N/A	N/A	\$4692.17	\$5687.41
	54"(1372mm)	X4CA-2354-NSWNNW	1	2	N/A	N/A	4944.71	5955.11
	60"(1524mm)	X4CA-2360-NSWNNW	1	2	N/A	N/A	5197.25	6222.81
	66"(1676mm)	X4CA-2366-NSWNNW	1	2	N/A	N/A	5449.79	6490.51
	72"(1829mm)	X4CA-2372-NSWNNW	1	2	N/A	N/A	5702.33	6758.21
	78"(1981mm)	X4CA-2378-NSWNNW	2	3	N/A	N/A	5954.87	7025.91
	84"(2134mm)	X4CA-2384-NSWNNW	2	3	N/A	N/A	6207.41	7293.61
	90"(2286mm)	X4CA-2390-NSWNNW	2	3	N/A	N/A	6459.95	7561.31
	96"(2438mm)	X4CA-2396-NSWNNW	2	3	N/A	N/A	6712.49	7829.01
	102"(2591mm)	X4CA-23A2-NSWNNW	2	3	N/A	N/A	6965.03	8096.71
	108"(2743mm)	X4CA-23A8-NSWNNW	2	3	N/A	N/A	7217.57	8364.41

# Masters Series

## 1.5H Attached Sliding Door Storage Unit for use with Convergent Worktop

### 1.5H Attached Sliding Door Storage Unit for use with Convergent Worktop

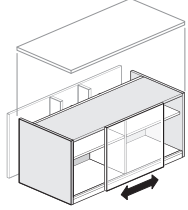

48" - 72" W  
(1 Sliding Doors)

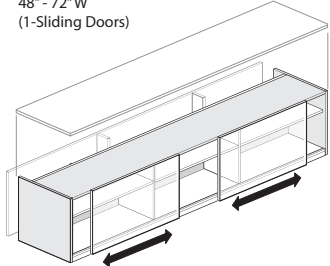

78" - 108" W  
(2 Sliding Doors)

X5CB-2348  
X4CB-2348

### Feature

- Includes case with optional finished back panel, non-locking sliding door, 5"(127mm) deep full height wire way and adjustable shelf.

### Specification Tips

- May be used as a stand alone unit or may be used adjacent to 1.5H attached lower storage units.
- Back of storage unit has a 5"(127mm) deep full height open wireway intended to conceal a height adjustable T-Leg included with a Height Adjustable Convergent Worktop.
- May be used to support a Convergent Worktop - For use with 1.5H Storage (fixed height convergent worktop with stanchion).
- Requires a separately specified Credenza Top.
- The optional finished back panel is .75"(19mm) thick and will increase the overall depth of the attached storage unit.

### To Order, Specify:

#### No Back

- 1) Product number.
- 2) Laminate surface color or wood finish for case and door.
- 3) Edge trim color (laminated only).

#### With Finished Back

- 1) Product number.
- 2) Laminate surface color or wood finish for case, back and door.
- 3) Edge trim color (laminated only).



## Masters Series

1.5H Attached Sliding Door Storage Unit for use with Convergent Worktop

Depth	Width	Number	Number of Door(s) and Divider(s)	Shelf(s)	Laminate		Wood Group A	Wood Group B
					A	B		
<b>Laminate Door — No back</b>								
23"(584mm)	48"(1219mm)	X5CB-2348-NSNNL	1	2	\$2558.56	\$2574.22	N/A	N/A
	54"(1372mm)	X5CB-2354-NSNNL	1	2	2691.74	2718.07	N/A	N/A
	60"(1524mm)	X5CB-2360-NSNNL	1	2	2824.92	2861.92	N/A	N/A
	66"(1676mm)	X5CB-2366-NSNNL	1	2	2958.10	3005.77	N/A	N/A
	72"(1829mm)	X5CB-2372-NSNNL	1	2	3091.28	3149.62	N/A	N/A
	78"(1981mm)	X5CB-2378-NSNNL	2	3	3224.46	3293.47	N/A	N/A
	84"(2134mm)	X5CB-2384-NSNNL	2	3	3357.64	3437.32	N/A	N/A
	90"(2286mm)	X5CB-2390-NSNNL	2	3	3490.82	3581.17	N/A	N/A
	96"(2438mm)	X5CB-2396-NSNNL	2	3	3624.00	3725.02	N/A	N/A
	102"(2591mm)	X5CB-23A2-NSNNL	2	3	3757.18	3868.87	N/A	N/A
	108"(2743mm)	X5CB-23A8-NSNNL	2	3	3890.36	4012.72	N/A	N/A
<b>Wood Door — No back</b>								
23"(584mm)	48"(1219mm)	X4CB-2348-NSNNW	1	2	N/A	N/A	\$3728.60	\$4676.57
	54"(1372mm)	X4CB-2354-NSNNW	1	2	N/A	N/A	3961.35	4923.31
	60"(1524mm)	X4CB-2360-NSNNW	1	2	N/A	N/A	4194.10	5170.05
	66"(1676mm)	X4CB-2366-NSNNW	1	2	N/A	N/A	4426.85	5416.79
	72"(1829mm)	X4CB-2372-NSNNW	1	2	N/A	N/A	4659.60	5663.53
	78"(1981mm)	X4CB-2378-NSNNW	2	3	N/A	N/A	4892.35	5910.27
	84"(2134mm)	X4CB-2384-NSNNW	2	3	N/A	N/A	5125.10	6157.01
	90"(2286mm)	X4CB-2390-NSNNW	2	3	N/A	N/A	5357.85	6403.75
	96"(2438mm)	X4CB-2396-NSNNW	2	3	N/A	N/A	5590.60	6650.49
	102"(2591mm)	X4CB-23A2-NSNNW	2	3	N/A	N/A	5823.35	6897.23
	108"(2743mm)	X4CB-23A8-NSNNW	2	3	N/A	N/A	6056.10	7143.97
<b>Laminate Door — With Finished Back</b>								
23"(584mm)	48"(1219mm)	X5CB-2348-NSLNL	1	2	\$2921.98	\$2937.64	N/A	N/A
	54"(1372mm)	X5CB-2354-NSLNL	1	2	3055.16	3081.49	N/A	N/A
	60"(1524mm)	X5CB-2360-NSLNL	1	2	3188.34	3225.34	N/A	N/A
	66"(1676mm)	X5CB-2366-NSLNL	1	2	3321.52	3369.19	N/A	N/A
	72"(1829mm)	X5CB-2372-NSLNL	1	2	3454.70	3513.04	N/A	N/A
	78"(1981mm)	X5CB-2378-NSLNL	2	3	3587.88	3656.89	N/A	N/A
	84"(2134mm)	X5CB-2384-NSLNL	2	3	3721.06	3800.74	N/A	N/A
	90"(2286mm)	X5CB-2390-NSLNL	2	3	3854.24	3944.59	N/A	N/A
	96"(2438mm)	X5CB-2396-NSLNL	2	3	3987.42	4088.44	N/A	N/A
	102"(2591mm)	X5CB-23A2-NSLNL	2	3	4120.60	4232.29	N/A	N/A
	108"(2743mm)	X5CB-23A8-NSLNL	2	3	4253.78	4376.14	N/A	N/A
<b>Wood Door — With Finished back</b>								
23"(584mm)	48"(1219mm)	X4CB-2348-NSWNNW	1	2	N/A	N/A	\$4332.91	\$5280.88
	54"(1372mm)	X4CB-2354-NSWNNW	1	2	N/A	N/A	4565.66	5527.62
	60"(1524mm)	X4CB-2360-NSWNNW	1	2	N/A	N/A	4798.41	5774.36
	66"(1676mm)	X4CB-2366-NSWNNW	1	2	N/A	N/A	5031.16	6021.10
	72"(1829mm)	X4CB-2372-NSWNNW	1	2	N/A	N/A	5263.91	6267.84
	78"(1981mm)	X4CB-2378-NSWNNW	2	3	N/A	N/A	5496.66	6514.58
	84"(2134mm)	X4CB-2384-NSWNNW	2	3	N/A	N/A	5729.41	6761.32
	90"(2286mm)	X4CB-2390-NSWNNW	2	3	N/A	N/A	5962.16	7008.06
	96"(2438mm)	X4CB-2396-NSWNNW	2	3	N/A	N/A	6194.91	7254.80
	102"(2591mm)	X4CB-23A2-NSWNNW	2	3	N/A	N/A	6427.66	7501.54
	108"(2743mm)	X4CB-23A8-NSWNNW	2	3	N/A	N/A	6660.41	7748.28

# Masters Series

## 2H Attached Sliding Door Storage Unit

### 2H Attached Sliding Door Storage Unit

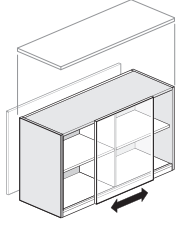

48" - 72" W  
(1 Sliding Doors)

X55A-1848  
X45A-1848

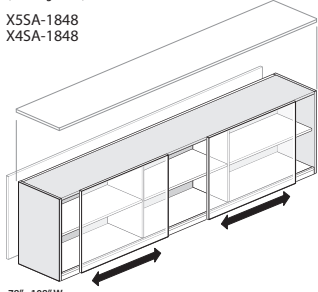

78" - 108" W  
(2 Sliding Doors)

X55A-1848  
X45A-1848

### Feature

- Includes case with optional back panel , non-locking sliding door(s) and adjustable shelf.

### Specification Tips

- May be used as a stand alone unit.
- May be used adjacent to applicable attached lower storage or modular components to design a credenza storage unit.
- Not for use with a Convergent Worktop.
- Requires a separately specified Credenza Top.
- The optional finished back panel is .75"(19mm) thick and will increase the overall depth of the attached storage unit.

### To Order, Specify:

#### No Back

- 1) Product number.
- 2) Laminate surface color or wood finish for case and door.
- 3) Edge trim color (laminated only).

#### With Finished Back

- 1) Product number.
- 2) Laminate surface color or wood finish for case, back and door.
- 3) Edge trim color (laminated only).

## Masters Series

2H Attached Sliding Door Storage Unit

Depth	Width	Number	Number of Door(s) and Divider(s)	Shelf(s)	Laminate A	B	Wood Group A	Wood Group B
<b>Laminate Door — No back</b>								
18"(457mm)	48"(1219mm)	X55A-1848-NSNNL	1	2	\$2500.66	\$2506.48	N/A	N/A
	54"(1372mm)	X55A-1854-NSNNL	1	2	2645.16	2662.55	N/A	N/A
	60"(1524mm)	X55A-1860-NSNNL	1	2	2789.66	2818.62	N/A	N/A
	66"(1676mm)	X55A-1866-NSNNL	1	2	2934.16	2974.69	N/A	N/A
	72"(1829mm)	X55A-1872-NSNNL	1	2	3078.66	3130.76	N/A	N/A
	78"(1981mm)	X55A-1878-NSNNL	2	3	3223.16	3286.83	N/A	N/A
	84"(2134mm)	X55A-1884-NSNNL	2	3	3367.66	3442.90	N/A	N/A
	90"(2286mm)	X55A-1890-NSNNL	2	3	3512.16	3598.97	N/A	N/A
	96"(2438mm)	X55A-1896-NSNNL	2	3	3656.66	3755.04	N/A	N/A
	102"(2591mm)	X55A-18A2-NSNNL	2	3	3801.16	3911.11	N/A	N/A
	108"(2743mm)	X55A-18A8-NSNNL	2	3	3945.66	4067.18	N/A	N/A
<b>Wood Door — No back</b>								
18"(457mm)	48"(1219mm)	X45A-1848-NSNNW	1	2	N/A	N/A	\$3345.22	\$4299.81
	54"(1372mm)	X45A-1854-NSNNW	1	2	N/A	N/A	3597.76	4567.51
	60"(1524mm)	X45A-1860-NSNNW	1	2	N/A	N/A	3850.30	4835.21
	66"(1676mm)	X45A-1866-NSNNW	1	2	N/A	N/A	4102.84	5102.91
	72"(1829mm)	X45A-1872-NSNNW	1	2	N/A	N/A	4355.38	5370.61
	78"(1981mm)	X45A-1878-NSNNW	2	3	N/A	N/A	4607.92	5638.31
	84"(2134mm)	X45A-1884-NSNNW	2	3	N/A	N/A	4860.46	5906.01
	90"(2286mm)	X45A-1890-NSNNW	2	3	N/A	N/A	5113.00	6173.71
	96"(2438mm)	X45A-1896-NSNNW	2	3	N/A	N/A	5365.54	6441.41
	102"(2591mm)	X45A-18A2-NSNNW	2	3	N/A	N/A	5618.08	6709.11
	108"(2743mm)	X45A-18A8-NSNNW	2	3	N/A	N/A	5870.62	6976.81
<b>Laminate Door — With Finished Back</b>								
18"(457mm)	48"(1219mm)	X55A-1848-NSLNL	1	2	\$2894.96	\$2900.78	N/A	N/A
	54"(1372mm)	X55A-1854-NSLNL	1	2	3039.46	3056.85	N/A	N/A
	60"(1524mm)	X55A-1860-NSLNL	1	2	3183.96	3212.92	N/A	N/A
	66"(1676mm)	X55A-1866-NSLNL	1	2	3328.46	3368.99	N/A	N/A
	72"(1829mm)	X55A-1872-NSLNL	1	2	3472.96	3525.06	N/A	N/A
	78"(1981mm)	X55A-1878-NSLNL	2	3	3617.46	3681.13	N/A	N/A
	84"(2134mm)	X55A-1884-NSLNL	2	3	3761.96	3837.20	N/A	N/A
	90"(2286mm)	X55A-1890-NSLNL	2	3	3906.46	3993.27	N/A	N/A
	96"(2438mm)	X55A-1896-NSLNL	2	3	4050.96	4149.34	N/A	N/A
	102"(2591mm)	X55A-18A2-NSLNL	2	3	4195.46	4305.41	N/A	N/A
	108"(2743mm)	X55A-18A8-NSLNL	2	3	4339.96	4461.48	N/A	N/A
<b>Wood Door — With Finished back</b>								
18"(457mm)	48"(1219mm)	X45A-1848-NSWNNW	1	2	N/A	N/A	\$4014.37	\$4968.96
	54"(1372mm)	X45A-1854-NSWNNW	1	2	N/A	N/A	4266.91	5236.66
	60"(1524mm)	X45A-1860-NSWNNW	1	2	N/A	N/A	4519.45	5504.36
	66"(1676mm)	X45A-1866-NSWNNW	1	2	N/A	N/A	4771.99	5772.06
	72"(1829mm)	X45A-1872-NSWNNW	1	2	N/A	N/A	5024.53	6039.76
	78"(1981mm)	X45A-1878-NSWNNW	2	3	N/A	N/A	5277.07	6307.46
	84"(2134mm)	X45A-1884-NSWNNW	2	3	N/A	N/A	5529.61	6575.16
	90"(2286mm)	X45A-1890-NSWNNW	2	3	N/A	N/A	5782.15	6842.86
	96"(2438mm)	X45A-1896-NSWNNW	2	3	N/A	N/A	6034.69	7110.56
	102"(2591mm)	X45A-18A2-NSWNNW	2	3	N/A	N/A	6287.23	7378.26
	108"(2743mm)	X45A-18A8-NSWNNW	2	3	N/A	N/A	6539.77	7645.96

# Masters Series

## 3H Freestanding Open Storage Unit

Height	Depth	Width	Number	Laminate		Wood	
				A	B	Group A	Group B
<b>Laminate</b>							
41.625"(1057mm)	19"(483mm)	30"(762mm)	X5N3-1930-NSSNN	\$1909.92	\$2104.34		
		36"(914mm)	X5N3-1936-NSSNN	1976.26	2170.68		
	24"(610mm)	30"(762mm)	X5N3-2430-NSSNN	\$2486.60	\$2681.02		
		36"(914mm)	X5N3-2436-NSSNN	2552.94	2747.36		
<b>Wood</b>							
41.625"(1057mm)	19"(483mm)	30"(762mm)	X4N3-1930-NSSNN			\$2791.67	\$3110.22
		36"(914mm)	X4N3-1936-NSSNN			2858.01	3176.56
	24"(610mm)	30"(762mm)	X4N3-2430-NSSNN			\$3368.35	\$3686.90
		36"(914mm)	X4N3-2436-NSSNN			3434.69	3753.24

### 3H Open Storage Unit

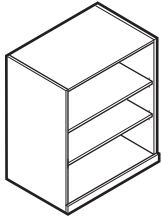

X4N3-NN  
X5N3-NN

#### Features

- Includes case, two adjustable shelves; inset unfinished back and glides.
- Adjustable .75"(19mm) thick shelf has  $\pm 1.25$ "(32mm) adjustment range.
- Glides provide 2"(51mm) adjustment range.
- Shipped assembled.

#### Specification Tips

- Not for use with stack-on storage unit.
- Includes .75"(19mm) proud kick plate.

#### To Order, Specify:

- 1) Product number.
- 2) Finish code (laminate or wood).
- 3) Laminate edge trim color (if laminate specified).

# Masters Series

## 3H Freestanding Storage Unit with Hinged Doors

Height	Depth	Width	Number ① ②	Laminate		Wood	
				A	B	Group A	Group B
<b>Laminate</b>							
41.625"(1057mm)	19"(483mm)	30"(762mm)	X5H3-1930- SS L	\$2226.16	\$2366.82		
		36"(914mm)	X5H3-1936- SS L	2265.66	2406.32		
	24"(610mm)	30"(762mm)	X5H3-2430- SS L	\$2794.93	\$2935.59		
		36"(914mm)	X5H3-2436- SS L	2834.43	2975.09		
<b>Wood</b>							
41.625"(1057mm)	19"(483mm)	30"(762mm)	X4H3-1930- SS W			\$3289.29	\$3668.11
		36"(914mm)	X4H3-1936- SS W			3336.41	3727.48
	24"(610mm)	30"(762mm)	X4H3-2430- SS W			\$3879.05	\$4270.86
		36"(914mm)	X4H3-2436- SS W			3926.17	4330.23

### 3H Freestanding Storage Unit with Hinged Doors

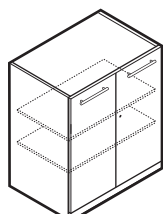

X4H3-LW  
X5H3-LL

#### Features

- Includes case, doors with concealed hinges, one adjustable shelf and one fixed shelf; inset unfinished back and glides.
- Adjustable .75"(19mm) thick shelf has ±1.25"(32mm) adjustment range.
- Door pull options:
  - Finger pull option indicates door with touch latch.
  - Bar pulls available in powdercoat finish.
  - Linear and Classic available in satin nickel finish only.
- Optional lock available; lock plug available in black or chrome.
- For lock options, refer to Lock Program section of the Accessories Price List.
- Glides provide 2"(51mm) adjustment range.
- Shipped assembled.

#### Specification Tips

- Not for use with stack-on storage unit.
- Not designed for application where back of unit is visible.

#### To Order, Specify:

1) Product number, including:

##### ① Door Pull Option:

- F** Finger (Touch latch)
- B** Bar
- 8** Linear
- 9** Classic

##### ② Lock Option:





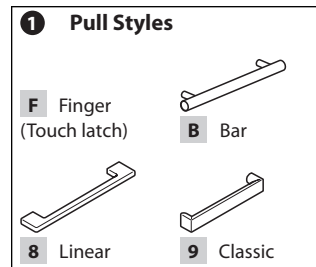











- N** No Lock
- L** Lock, add \$169.05 list

- 2) Finish code (laminate or wood).
- 3) Laminate edge trim color (if laminate specified).
- 4) Trim color for bar pull (if specified).
- 5) Trim color for lock (if specified).



# Masters Series

Freestanding Lateral Files — 3H and 4H

Height	Depth	Width	Number <sup>1</sup> <sup>2</sup>	Laminate		Wood	
				A	B	Group A	Group B
<b>Laminate — 3H</b>							
41.625"(1057mm)	19"(483mm)	30"(762mm)	X5F3-1930-N  SSBLL	\$2884.84	\$3224.06		
		36"(914mm)	X5F3-1936-N  SSBLL	3078.19	3417.41		
	24"(610mm)	30"(762mm)	X5F3-2430-N  SSBLL	3001.80	3341.02		
		36"(914mm)	X5F3-2436-N  SSBLL	3195.15	3534.37		
<b>Laminate — 4H</b>							
55.3125"(1405mm)	19"(483mm)	30"(762mm)	X5F4-1930-N  SSBLL	\$3505.92	\$3894.84		
		36"(914mm)	X5F4-1936-N  SSBLL	3699.27	4088.19		
	24"(610mm)	30"(762mm)	X5F4-2430-N  SSBLL	3622.88	4011.80		
		36"(914mm)	X5F4-2436-N  SSBLL	3816.23	4205.15		
<b>Wood — 3H</b>							
41.625"(1057mm)	19"(483mm)	30"(762mm)	X4F3-1930-N  SSBLW			\$4523.51	\$5001.71
		36"(914mm)	X4F3-1936-N  SSBLW			4772.74	5279.63
	24"(610mm)	30"(762mm)	X4F3-2430-N  SSBLW			4640.47	5132.62
		36"(914mm)	X4F3-2436-N  SSBLW			4889.70	5410.54
<b>Wood — 4H</b>							
55.3125"(1405mm)	19"(483mm)	30"(762mm)	X4F4-1930-N  SSBLW			\$5582.89	\$6167.01
		36"(914mm)	X4F4-1936-N  SSBLW			5832.12	6444.93
	24"(610mm)	30"(762mm)	X4F4-2430-N  SSBLW			5699.85	6297.92
		36"(914mm)	X4F4-2436-N  SSBLW			5949.08	6575.84

## Freestanding Lateral File – 3H and 4H

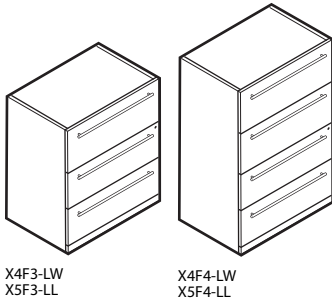

### Features

- Includes finished inset top and case and three or four lateral file drawers; inset unfinished back and glides.
- File drawer with an integrated file hanging system.
- Two file hanging bars included per file drawer.
- File drawers have full extension slides with integrated anti-tip interlock feature.
- Drawer pull options:
  - Bar pulls available in powdercoat finishes.
  - Linear and Classic pulls are available in satin nickel finish only.
  - Finger pull option available with Wood Group B finishes.
- One lock standard per lateral file; includes dual lock bar system.
- Lock plug is available in black or chrome.
- For lock options, refer to Lock Program section of the Accessories Price List.
- Glides provide 2"(51mm) adjustment range.
- Shipped assembled.

### Specification Tips

- Not for use with stack-on storage unit.
- 3H lateral file includes counterweight.
- 4H lateral file does not require counterweight.
- Separately specify a credeza top for more than one file application.

### To Order, Specify:

1) Product number, including:

#### 1 File Drawer Option:

- S** Black Miterfold
- W** Wood  
3H, add \$258.79 list  
4H, add \$344.45 list

#### 2 Drawer Pull Option:

- F** Finger (Wood only)
- B** Bar
- 8** Linear
- 9** Classic

- 2) Finish code (laminate or wood).
- 3) Laminate edge trim color (if laminate specified).
- 4) Trim color for bar pull (if specified).
- 5) Trim color for lock (required).

### 2 Pull Styles

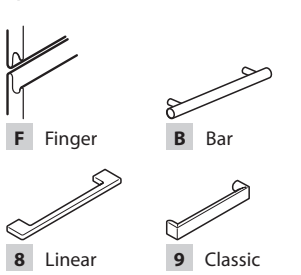

## Masters Series

Freestanding Lateral Files — 3H and 4H

Height	Depth	Width	Number ① ② ③	Laminate		Wood	
				A	B	Group A	Group B
<b>Laminate — 5H</b>							
69"(1753mm)	19"(483mm)	30"(762mm)	X5F5-1930-N █ █ SSB █ L	<b>\$4890.13</b>	<b>\$5403.32</b>		
		36"(914mm)	X5F5-1936-N █ █ SSB █ L	<b>5083.48</b>	<b>5596.67</b>		
	24"(610mm)	30"(762mm)	X5F5-2430-N █ █ SSB █ L	<b>5007.09</b>	<b>5520.28</b>		
		36"(914mm)	X5F5-2436-N █ █ SSB █ L	<b>5200.44</b>	<b>5713.63</b>		
<b>Laminate — 6H</b>							
81.625 "(2073mm)	19"(483mm)	30"(762mm)	X5F6-1930-N █ █ SSB █ L	<b>\$5287.46</b>	<b>\$5832.42</b>		
		36"(914mm)	X5F6-1936-N █ █ SSB █ L	<b>5480.81</b>	<b>6025.77</b>		
	24"(610mm)	30"(762mm)	X5F6-2430-N █ █ SSB █ L	<b>5404.42</b>	<b>5949.38</b>		
		36"(914mm)	X5F6-2436-N █ █ SSB █ L	<b>5597.77</b>	<b>6142.73</b>		
<b>Wood — 5H</b>							
69"(1753mm)	19"(483mm)	30"(762mm)	X4F5-1930-N █ █ SSB █ W			<b>\$8063.27</b>	<b>\$ 8892.14</b>
		36"(914mm)	X4F5-1936-N █ █ SSB █ W			<b>8312.50</b>	<b>9170.06</b>
	24"(610mm)	30"(762mm)	X4F5-2430-N █ █ SSB █ W			<b>8180.23</b>	<b>9023.05</b>
		36"(914mm)	X4F5-2436-N █ █ SSB █ W			<b>8429.46</b>	<b>9300.97</b>
<b>Wood — 6H</b>							
81.625 "(2073mm)	19"(483mm)	30"(762mm)	X4F6-1930-N █ █ SSB █ W			<b>\$8741.01</b>	<b>\$ 9637.68</b>
		36"(914mm)	X4F6-1936-N █ █ SSB █ W			<b>8990.24</b>	<b>9915.60</b>
	24"(610mm)	30"(762mm)	X4F6-2430-N █ █ SSB █ W			<b>8857.97</b>	<b>9768.59</b>
		36"(914mm)	X4F6-2436-N █ █ SSB █ W			<b>9107.20</b>	<b>10046.51</b>

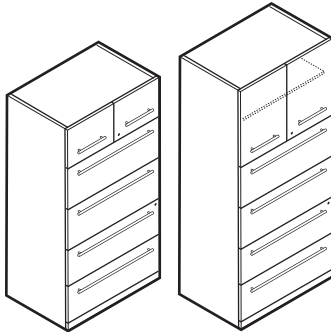
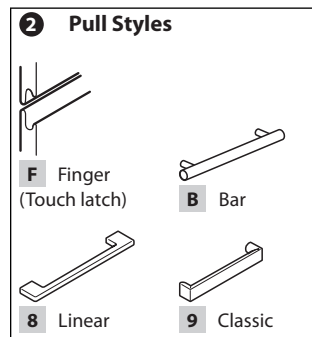
Freestanding Lateral File –  
5H and 6HX4F5-LW  
X5F5-LLX4F6-LW  
X5F6-LL

## Features

- Includes finished top and case, four lateral file drawers and storage cabinet; inset unfinished back and glides.
- File drawer with an integrated file hanging system.
- Two file hanging bars included per file drawer.
- File drawers have full extension slides with integrated anti-tip interlock feature.
- Drawer pull options:
  - Bar pulls available in powdercoat finishes.
  - Linear and Classic pulls are available in satin nickel finish only.
  - Finger pull option includes touch latch on the storage cabinet doors and routed finger pull on cabinet drawers.
  - Finger pull option available with Wood Group B finishes.
- One lock standard per lateral file includes dual lock bar system; optional lock available for upper storage cabinet.
- Lock plug is available in black or chrome.
- For lock options, refer to Lock Program section of the Accessories Price List.
- 6H includes one adjustable shelf.
- Adjustable .75"(19mm) thick shelf has  $\pm 1.25$ "(32mm) adjustment range.
- Glides provide 2"(51mm) adjustment range.
- Shipped assembled.

## Specification Tip

- Not designed for application where back of unit is visible.

## To Order, Specify:

- 1) Product number, including:

## ① File Drawer Option:

- S** Black Miterfold
- W** Wood, add **\$344.45** list

## ② Drawer Pull Option:

- F** Finger (Touch latch) (Wood only)
- B** Bar
- 8** Linear
- 9** Classic

## ③ Storage Cabinet Lock Option:

- N** No Lock
- L** Lock, add **\$169.05** list

- 2) Finish code (laminate or wood).
- 3) Laminate edge trim color (if laminate specified).
- 4) Trim color for bar pull (if specified).
- 5) Trim color for lock (required).

# Masters Series

## Combination Units with Lateral File

Height	Depth	Width	Number	Laminate		Wood	
				A	B	Group A	Group B
<b>Laminate — 5H</b>							
69"(1753mm)	19"(483mm)	30"(762mm)	X5M5-1930-N	SSB	L	\$4003.28	\$4323.60
		36"(914mm)	X5M5-1936-N	SSB	L	4415.65	4744.27
	24"(610mm)	30"(762mm)	X5M5-2430-N	SSB	L	4107.55	4427.87
		36"(914mm)	X5M5-2436-N	SSB	L	4519.92	4848.54
<b>Laminate — 6H</b>							
81.625"(2073mm)	19"(483mm)	30"(762mm)	X5M6-1930-N	SSB	L	\$4260.81	\$4581.13
		36"(914mm)	X5M6-1936-N	SSB	L	4673.18	5001.80
	24"(610mm)	30"(762mm)	X5M6-2430-N	SSB	L	4365.08	4685.40
		36"(914mm)	X5M6-2436-N	SSB	L	4777.45	5106.07
<b>Wood — 5H</b>							
69"(1753mm)	19"(483mm)	30"(762mm)	X4M5-1930-N	SSB	W	\$6168.24	\$6877.07
		36"(914mm)	X4M5-1936-N	SSB	W	6647.32	7412.52
	24"(610mm)	30"(762mm)	X4M5-2430-N	SSB	W	6272.51	6981.34
		36"(914mm)	X4M5-2436-N	SSB	W	6751.59	7516.79
<b>Wood — 6H</b>							
81.625"(2073mm)	19"(483mm)	30"(762mm)	X4M6-1930-N	SSB	W	\$6467.67	\$7211.75
		36"(914mm)	X4M6-1936-N	SSB	W	6946.75	7747.20
	24"(610mm)	30"(762mm)	X4M6-2430-N	SSB	W	6571.94	7316.02
		36"(914mm)	X4M6-2436-N	SSB	W	7051.02	7851.47

### Combination Unit — 5H and 6H

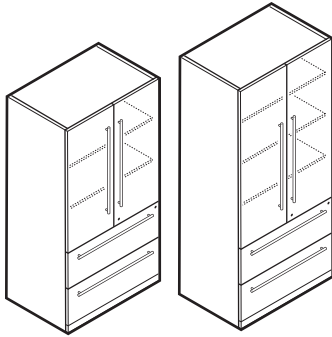

X4M5-LW  
X5M5-LL

X4M6-LW  
X5M6-LL

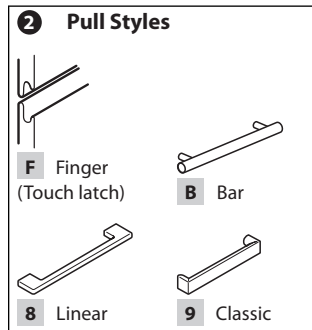

### 2 Pull Styles

F Finger  
(Touch latch)

B Bar

8 Linear

9 Classic

### Features

- Includes 2H lateral file drawers, storage cabinet with two adjustable shelves, unfinished back, glides and concealed hinges.
- Adjustable shelf has  $\pm 1.25$ " (32mm) adjustment range.
- File drawer with an integrated file hanging system.
- File drawers have full extension slides with integrated anti-tip interlock feature.
- Two file hanging bars included per file drawer.
- Drawer/door pull options:
  - Bar pulls available in powdercoat finishes.
  - Linear and Classic pulls are available in satin nickel finish only.
  - Finger pull option includes touch latch on the storage cabinet doors and routed finger pull on cabinet drawers.
  - Finger pull option available with Wood Group B finishes.
- One lock standard per lateral file includes dual lock bar system; Optional lock available for upper storage cabinet.
- Common keys within each storage unit.
- Lock plug is available in black or chrome.
- For lock options, refer to Lock Program section of the Accessories Price List.
- Two adjustable shelves included in 5H. One fixed and two adjustable shelves included in 6H.
- Adjustable shelf has  $\pm 1.25$ " (32mm) adjustment range.
- Glides provide 2" (51mm) adjustment range.
- Lateral file shipped assembled.

### Specification Tip

- Not designed for application where back of unit is visible.

### To Order, Specify:

- 1) Product number, including:

#### 1 File Drawer Option:

- S Black Miterfold
- W Wood, add \$174.86 list

#### 2 Drawer/Door Pull Option:

- F Finger (Touch latch) (Wood only)
- B Bar
- 8 Linear
- 9 Classic

#### 3 Storage Cabinet Lock Option:

- N No Lock
- L Lock, add \$169.05 list

- 2) Finish code (laminate or wood).
- 3) Laminate edge trim color (if laminate specified).
- 4) Trim color for bar pull (if specified).
- 5) Trim color for lock (required).



# Masters Series

Wardrobes with Open Unit

Height	Depth	Width	Number ① ② ③	Laminate		Wood	
				A	B	Group A	Group B
<b>Laminate — 5H</b>							
69"(1753mm)	19"(483mm)	30"(762mm)	X5W5-1930-■ SS ■ L ■	\$2989.89	\$3055.54		
		36"(914mm)	X5W5-1936-■ SS ■ L ■	3079.95	3145.60		
	24"(610mm)	30"(762mm)	X5W5-2430-■ SS ■ L ■	3964.72	4030.37		
		36"(914mm)	X5W5-2436-■ SS ■ L ■	4054.78	4120.43		
<b>Laminate — 6H</b>							
81.625"(2073mm)	19"(483mm)	30"(762mm)	X5W6-1930-■ SS ■ L ■	\$3718.24	\$3783.89		
		36"(914mm)	X5W6-1936-■ SS ■ L ■	3808.30	3873.95		
	24"(610mm)	30"(762mm)	X5W6-2430-■ SS ■ L ■	4693.07	4758.72		
		36"(914mm)	X5W6-2436-■ SS ■ L ■	4783.13	4848.78		
<b>Wood — 5H</b>							
69"(1753mm)	19"(483mm)	30"(762mm)	X4W5-1930-■ SS ■ W ■			\$4902.36	\$5451.11
		36"(914mm)	X4W5-1936-■ SS ■ W ■			5015.28	5604.08
	24"(610mm)	30"(762mm)	X4W5-2430-■ SS ■ W ■			6041.07	6723.76
		36"(914mm)	X4W5-2436-■ SS ■ W ■			6153.99	6876.73
<b>Wood — 6H</b>							
81.625"(2073mm)	19"(483mm)	30"(762mm)	X4W6-1930-■ SS ■ W ■			\$5745.03	\$6402.39
		36"(914mm)	X4W6-1936-■ SS ■ W ■			5857.95	6555.36
	24"(610mm)	30"(762mm)	X4W6-2430-■ SS ■ W ■			6883.74	7675.04
		36"(914mm)	X4W6-2436-■ SS ■ W ■			6996.66	7828.01

**Wardrobe with Open Unit — 5H and 6H**

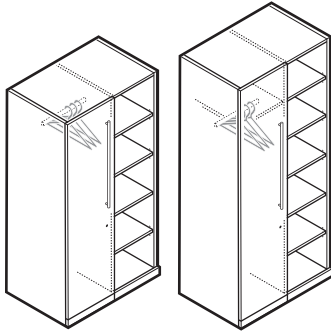

X4W5-WL  
X5W5-LL  
(Left-hand shown)

X4W6-WL  
X5W6-LL  
(Left-hand shown)

**Features**

- Includes open storage with shelves, wardrobe with chrome coat rod, glides and door complete with concealed hinges.
- Case and door front finished; unfinished back.
- Handed left (L) or right (R) by door hinge orientation.
- 5H includes one fixed shelf and three adjustable shelves.
- 6H includes one fixed shelf and four adjustable shelves.
- Fixed shelf in the second position from the bottom.
- Adjustable shelf has ±1.25"(32mm) adjustment range.
- Door pull options:
  - Finger pull option indicates door with touch latch.
  - Bar pulls available in powdercoat finishes.
  - Linear and Classic pulls are available in satin nickel finish only.
- Optional lock available; lock plug available in black or chrome.
- For lock options, refer to Lock Program section of the Accessories Price List.
- Glides provide 1"(25mm) adjustment range.
- Shipped assembled.

**Specification Tip**

- Not designed for application where back of unit is visible.

**To Order, Specify:**

- 1) Product number, including:

**① Door Pull Option:**

- F** Finger (Touch latch)
- B** Bar
- 8** Linear
- 9** Classic

**② Lock Option:**

- N** No Lock
- L** Lock, add \$169.05 list

**③ Wardrobe Orientation:**

- L** Left-hand
- R** Right-hand

- 2) Finish code (laminate or wood).
- 3) Laminate edge trim color (if laminate specified).
- 4) Trim color for bar pull (if specified).
- 5) Trim color for lock (if specified).

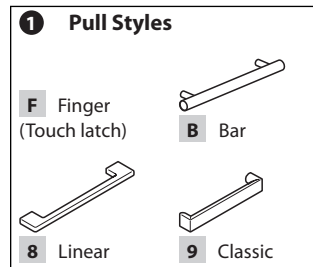

# Masters Series

## Wardrobes with Closed Storage Unit

Height	Depth	Width	Number ① ②	Laminate		Wood	
				A	B	Group A	Group B
<b>Laminate — 5H</b>							
69"(1753mm)	19"(483mm)	30"(762mm)	X5X5-1930- SS L	\$3392.78	\$3458.43		
		36"(914mm)	X5X5-1936- SS L	3482.84	3548.49		
	24"(610mm)	30"(762mm)	X5X5-2430- SS L	4367.61	4433.26		
		36"(914mm)	X5X5-2436- SS L	4457.67	4523.32		
<b>Laminate — 6H</b>							
81.625"(2073mm)	19"(483mm)	30"(762mm)	X5X6-1930- SS L	\$4121.13	\$4186.78		
		36"(914mm)	X5X6-1936- SS L	4211.19	4276.84		
	24"(610mm)	30"(762mm)	X5X6-2430- SS L	5095.96	5161.61		
		36"(914mm)	X5X6-2436- SS L	5186.02	5251.67		
<b>Wood — 5H</b>							
69"(1753mm)	19"(483mm)	30"(762mm)	X4X5-1930- SS W			\$5630.50	\$6179.25
		36"(914mm)	X4X5-1936- SS W			5743.42	6332.22
	24"(610mm)	30"(762mm)	X4X5-2430- SS W			6769.21	7451.90
		36"(914mm)	X4X5-2436- SS W			6882.13	7604.87
<b>Wood — 6H</b>							
81.625"(2073mm)	19"(483mm)	30"(762mm)	X4X6-1930- SS W			\$6473.17	\$7130.53
		36"(914mm)	X4X6-1936- SS W			6586.09	7283.50
	24"(610mm)	30"(762mm)	X4X6-2430- SS W			7611.88	8403.18
		36"(914mm)	X4X6-2436- SS W			7724.80	8556.15

### Wardrobe with Closed Storage Unit — 5H and 6H

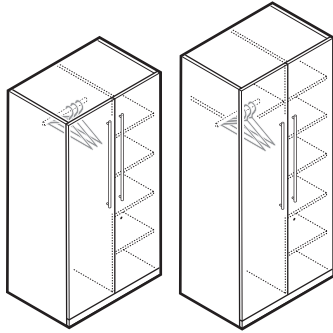

X4X5-LW  
X5X5-LL

X4X6-LW  
X5X6-LL

### Features

- Includes wardrobe with chrome coat rod on left side, storage cabinet with shelves on right side, glides and doors with concealed hinges.
- Case and door front finished; unfinished back.
- 5H includes one fixed shelf and three adjustable shelves.
- 6H includes one fixed shelf and four adjustable shelves.
- Fixed shelf in the second position from the bottom.
- Adjustable shelf has  $\pm 1.25"$  (32mm) adjustment range.
- Door pull options:
  - Finger pull option indicates door with touch latch.
  - Bar pulls available in powdercoat finishes.
  - Linear and Classic pulls are available in satin nickel finish only.
- Optional lock available; lock plug available in black or chrome.
- For lock options, refer to Lock Program section of the Accessories Price List.
- Glides provide 1"(25mm) adjustment range.
- Shipped assembled.

### Specification Tip

- Not designed for application where back of unit is visible.

### To Order, Specify:

- 1) Product number, including:

#### ① Door Pull Option:

- F** Finger (Touch latch)
- B** Bar
- 8** Linear
- 9** Classic

#### ② Lock Option:

- N** No Lock
- L** Lock, add \$169.05 list

- 2) Finish code (laminated or wood).
- 3) Laminate edge trim color (if laminate specified).
- 4) Trim color for bar pull (if specified).
- 5) Trim color for lock (if specified).

### ① Pull Styles

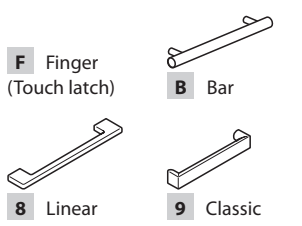

## Masters Series

## Personal Storage Towers with Valet

Height	Depth	Width	Number	① ② ③ ④				Laminate		Wood	
				A	B	Group A	Group B				
<b>Laminate — 5H</b>											
69"(1753mm)	24"(610mm)	24"(610mm)	X5AD-6924-	■	■	SSS	■	L	\$4099.81	\$4511.85	
<b>Laminate — 6H</b>											
81.625"(2073mm)	24"(610mm)	24"(610mm)	X5AD-8124-	■	■	SSS	■	L	\$4971.94	\$5453.68	
<b>Wood — 5H</b>											
69"(1753mm)	24"(610mm)	24"(610mm)	X4AD-6924-	■	■	SSS	■	W			\$6259.85 \$6979.87
<b>Wood — 6H</b>											
81.625"(2073mm)	24"(610mm)	24"(610mm)	X4AD-8124-	■	■	SSS	■	W			\$7277.99 \$8124.56

## Personal Storage Tower with F/F/F and Valet

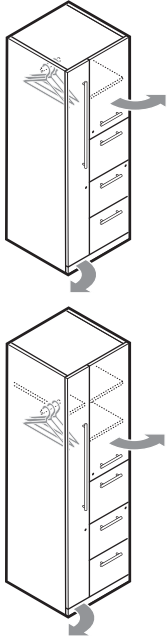

X4AD-WL  
X5AD-LL  
(Left-hand shown)

## Features

- Includes three file drawers, closed storage with two adjustable shelves, glides and valet with chrome coat rod.
- Case and door front finished; unfinished back.
- 5H includes one adjustable shelf in the storage cabinet.
- 6H includes two adjustable shelves in the storage cabinet and a removable hat shelf in the valet.
- Adjustable shelf has  $\pm 1.25"$  (32mm) adjustment range.
- Two file hanging bars included per file drawer.
- File drawers have full extension slides.
- Drawer/door pull options:
  - Bar pulls available in powdercoat finishes.
  - Linear and Classic pulls are available in satin nickel finish only.
  - Finger pull option includes touch latch on the storage cabinet doors and routed finger pull on cabinet drawers.
  - Finger pull option available with Wood Group B finishes.
- Letter width 15.5" (394mm) pedestal.
- One lock standard for file drawers; optional lock available for upper storage cabinet and valet.
- Common keys within each storage unit.
- Lock plug is available in black or chrome.
- For lock options, refer to Lock Program section of the Accessories Price List.
- Glides provide 1" (25mm) adjustment range.
- Shipped assembled.

## Specification Tip

- Not designed for application where back of unit is visible.

## To Order, Specify:

- 1) Product number, including:

## ① Drawer Option:

- S** Black Miterfold
- W** Wood, add \$224.84 list

## ② Drawer/Door Pull Option:

- F** Finger (Touch latch) (Wood only)
- B** Bar
- 8** Linear
- 9** Classic

## ③ Storage Cabinet/Valet Lock Option:

- N** No Lock
- L** Lock, add \$338.11 list

## ④ Valet Door Hinge Orientation:

- L** Left-hand
- R** Right-hand

- 2) Finish code (laminated or wood).
- 3) Laminate edge trim color (if laminate specified).
- 4) Trim color for bar pull (if specified).
- 5) Trim color for lock (required).

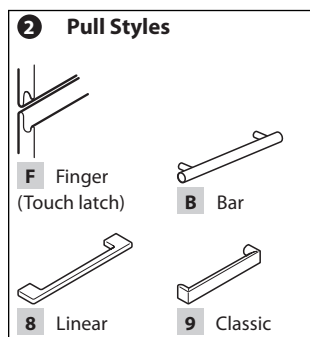

# Masters Series

## Personal Storage Towers with Valet

Height	Depth	Width	Number	①	②	③	④	Laminate A	B	Wood Group A	Group B
<b>Laminate — 5H</b>											
69"(1753mm)	24"(610mm)	24"(610mm)	X5AF-6924-	■	■	SSS	L	\$3350.23	\$3744.12		
<b>Laminate — 6H</b>											
81.625"(2073mm)	24"(610mm)	24"(610mm)	X5AF-8124-	■	■	SSS	L	\$4197.06	\$4709.45		
<b>Wood — 5H</b>											
69"(1753mm)	24"(610mm)	24"(610mm)	X4AF-6924-	■	■	SSS	W			\$5288.59	\$5892.85
<b>Wood — 6H</b>											
81.625"(2073mm)	24"(610mm)	24"(610mm)	X4AF-8124-	■	■	SSS	W			\$6135.42	\$6908.06

### Personal Storage Tower with F/F Pedestal and Valet — 5H and 6H

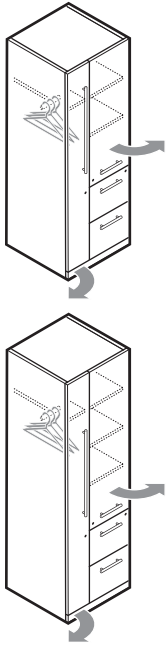

X4AF-WL  
X5AF-LL  
(Left-hand shown)

### Features

- Includes two file drawers, closed storage with adjustable shelves, glides and wardrobe with chrome coat rod.
- Case and door front finished; unfinished back.
- Handed left (L) or right (R) based on valet door hinge orientation.
- 5H includes two adjustable shelves in the storage cabinet.
- 6H includes three adjustable shelves in the storage cabinet and one additional shelf in the valet.
- Adjustable shelf has ±1.25"(32mm) adjustment range.
- Two file hanging bars included per file drawer.
- File drawers have full extension slides.
- Drawer and door pull options:
  - Bar pulls available in powdercoat finishes.
  - Linear and Classic pulls are available in satin nickel finish only.
  - Finger pull option includes touch latch on the storage cabinet doors and routed finger pull on cabinet drawers.
  - Finger pull option available with Wood Group B finishes.
- Letter width 15.5"(394mm) pedestals.
- One lock standard for file drawers; optional lock available for upper storage cabinet and valet.
- Common keys within each storage unit.
- Lock plug is available in black or chrome.
- For lock options, refer to Lock Program section of the Accessories Price List.
- Glides provide 1"(25mm) adjustment range.
- Shipped assembled.

### Specification Tip

- Not designed for application where back of unit is visible.

### To Order, Specify:

- 1) Product number, including:

#### ① Drawer Option:

- S** Black Miterfold
- W** Wood, add \$224.84 list

#### ② Drawer and Door Pull Options:

- F** Finger (Touch latch) (Wood only)
- B** Bar
- 8** Linear
- 9** Classic

#### ③ Storage Cabinet/Valet Lock Option:

- N** No Lock
- L** Lock, add \$338.11 list

#### ④ Valet Door Hinge Orientation:

- L** Left-hand
- R** Right-hand

- 2) Finish code (laminate or wood).
- 3) Laminate edge trim color (if laminate specified).
- 4) Trim color for bar pull (if specified).
- 5) Trim color for lock (required).

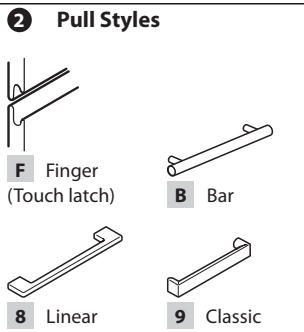

## Masters Series

Storage Tower

Height	Depth	Width	Number	① ② ③ ④				Laminate		Wood	
				A	B	Group A	Group B				
<b>Laminate — 5H</b>											
69"(1753mm)	19"(483mm)	15.5"(394mm)	X5ZF-6919-	■	■	SSS	L	\$2956.83	\$3319.28		
	24"(610mm)		X5ZF-6924-	■	■	SSS	L	3106.92	3481.37		
<b>Laminate — 6H</b>											
81.625"(2073mm)	19"(483mm)	15.5"(394mm)	X5ZF-8119-	■	■	SSS	L	\$3591.98	\$4056.05		
	24"(610mm)		X5ZF-8124-	■	■	SSS	L	3742.07	4218.14		
<b>Wood — 5H</b>											
69"(1753mm)	19"(483mm)	15.5"(394mm)	X4ZF-6919-	■	■	SSS	W			\$4895.19	\$5451.99
	24"(610mm)		X4ZF-6924-	■	■	SSS	W			5045.28	5620.18
<b>Wood — 6H</b>											
81.625"(2073mm)	19"(483mm)	15.5"(394mm)	X4ZF-8119-	■	■	SSS	W			\$5530.34	\$6240.28
	24"(610mm)		X4ZF-8124-	■	■	SSS	W			5680.43	6408.47

## Storage Tower — 5H and 6H

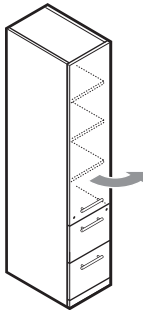
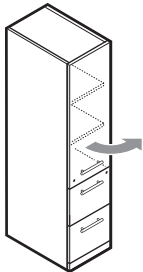

X4ZF-WR  
X5ZF-LR  
(Right-hand shown)

## Features

- Includes two file drawers, closed storage with adjustable shelves and glides.
- Case and door front finished; unfinished back.
- Handed left (L) or right (R) based on closed storage door hinge orientation.
- 5H includes two adjustable shelves in the storage cabinet.
- 6H includes three adjustable shelves in the storage cabinet.
- Adjustable shelf has  $\pm 1.25"$  (32mm) adjustment range.
- Two file hanging bars included per file drawer.
- File drawers have full extension slides.
- Drawer and door pull options:
  - Bar pulls available in powdercoat finishes.
  - Linear and Classic pulls are available in satin nickel finish only.
  - Finger pull option includes touch latch on the storage cabinet doors and routed finger pull on cabinet drawers.
  - Finger pull option available with Wood Group B finishes.
- Letter width 15.5"(394mm) pedestals.
- One lock standard for file drawers; optional lock available for upper storage cabinet and valet.
- Common keys within each storage unit.
- Lock plug is available in black or chrome.
- For lock options, refer to Lock Program section of the Accessories Price List.
- Glides provide 1"(25mm) adjustment range.
- Shipped assembled.

## Specification Tip

- Not designed for application where back of unit is visible.

## To Order, Specify:

- 1) Product number, including:

## ① Drawer Option:

- S** Black Miterfold
- W** Wood, add \$224.84 list

## ② Drawer and Door Pull Options:

- F** Finger (Touch latch) (Wood only)
- B** Bar
- 8** Linear
- 9** Classic

## ③ Storage Cabinet Lock Option:

- N** No Lock
- L** Lock, add \$169.05 list

## ④ Storage Door Hinge Orientation:

- L** Left-hand
- R** Right-hand

- 2) Finish code (laminate or wood).
- 3) Laminate edge trim color (if laminate specified).
- 4) Trim color for bar pull (if specified).
- 5) Trim color for lock (required).

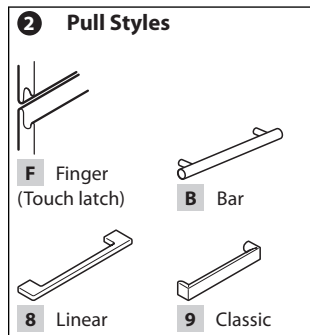

# Masters Series

## Freestanding Wardrobe Tower

Height	Depth	Nominal Width	Interior Width	Number ① ② ③	Laminate A	B	Wood Group A	Group B
<b>Laminate — 5H</b>								
69"(1753mm)	24"(610mm)	16"(406mm)	15.5"(394mm)	X5Y5-2416-SS L	\$1795.45	\$1861.10		
<b>Laminate — 6H</b>								
81.625"(2073mm)	24"(610mm)	16"(406mm)	15.5"(394mm)	X5Y6-2416-SS L	\$2523.80	\$2589.45		
<b>Wood — 5H</b>								
69"(1753mm)	24"(610mm)	16"(406mm)	15.5"(394mm)	X4Y5-2416-SS W			\$3818.46	\$4407.70
<b>Wood — 6H</b>								
81.625"(2073mm)	24"(610mm)	16"(406mm)	15.5"(394mm)	X4Y6-2416-SS W			\$4661.13	\$5358.98

### Freestanding Wardrobe Tower — 5H and 6H

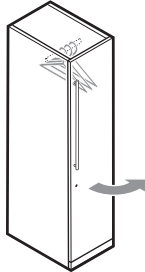

X4Y5-WR  
X5Y5-LR

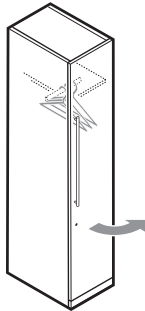

X4Y6-WR  
X5Y6-LR  
(Right-hand shown)

### Features

- Includes wardrobe cabinet with chrome coat rod; inset unfinished back and glides.
- Handed left (L) or right (R) by door hinge orientation.
- Case and door front finished; unfinished back.
- Door pull options:
  - Bar pulls available in powdercoat finishes.
  - Linear and Classic pulls are available in satin nickel finish only.
  - Finger pull option includes touch latch on the wardrobe door.
- Optional lock available; lock plug available in black or chrome.
- For lock options, refer to Lock Program section of the Accessories Price List.
- Glides provide 1"(25mm) adjustment range.
- Shipped assembled.

### Specification Tip

- Not designed for application where back of unit is visible.

### To Order, Specify:

- 1) Product number, including:

#### ① Door Pull Option:

- F** Finger (Touch latch)
- B** Bar
- 8** Linear
- 9** Classic

#### ② Lock Option:

- N** No Lock
- L** Lock, add \$169.05 list

#### ③ Door Hinge Orientation:

- L** Left-hand
- R** Right-hand

- 2) Finish code (laminated or wood).
- 3) Laminate edge trim color (if laminate specified).
- 4) Trim color for bar pull (if specified).
- 5) Trim color for lock (if specified).

### ① Pull Styles

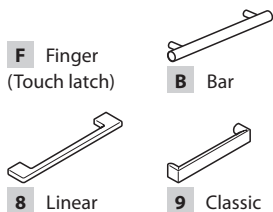

This page intentionally blank

# Masters Series

## Bookcases

### Bookcase — 2H, 3H, 4H, 5H and 6H

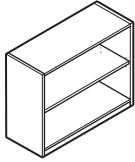

ULB2-S  
UXB2-S

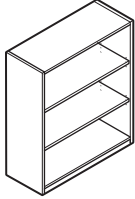

ULB3-S  
UXB3-S

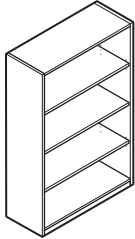

ULB4-S  
UXB4-S

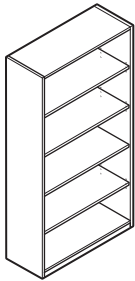

ULB5-S  
UXB5-S

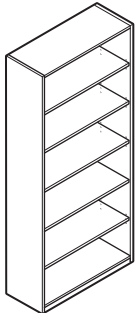

ULB6-S  
UXB6-S

### Features

- Includes bookcase with glides and finished top and shelves; inset unfinished back and inset toe kick.
  - 2H includes one adjustable shelf.
  - 3H includes two adjustable shelves.
  - 4H includes two adjustable shelves and one fixed shelf.
  - 5H includes three adjustable shelves and one fixed shelf.
  - 6H includes four adjustable shelves and one fixed shelf.
- Adjustable .75" (19mm) thick shelf has  $\pm 1.25$ " (32mm) adjustment range.
- .75" (19mm) thick fixed shelf in the second position from the bottom.
- Glides provide 1" (25mm) adjustment range.
- Shipped assembled.

### Specification Tip

- Not designed for application where back of unit is visible.

### To Order, Specify:

- 1) Product number.
- 2) Finish code (laminated or wood).
- 3) Laminate edge trim color (if laminate, paint or wood specified).



## Masters Series

Bookcases

Height	Depth	Width	Number	Laminate A	B	Wood Group A	Group B
<b>Laminate — Letter Depth — 2H</b>							
28"(711mm)	14"(356mm)	30"(762mm)	ULB2-1430-S	\$ 991.26	\$1071.20		
		36"(914mm)	ULB2-1436-S	1035.51	1115.45		
<b>Laminate — Letter Depth — 3H</b>							
41.625"(1057mm)	14"(356mm)	30"(762mm)	ULB3-1430-S	\$1022.74	\$1102.68		
		36"(914mm)	ULB3-1436-S	1093.85	1173.79		
<b>Laminate — Letter Depth — 4H</b>							
55.3125"(1405mm)	14"(356mm)	30"(762mm)	ULB4-1430-S	\$1041.89	\$1121.83		
		36"(914mm)	ULB4-1436-S	1138.27	1218.21		
<b>Laminate — Letter Depth — 5H</b>							
69"(1753mm)	14"(356mm)	30"(762mm)	ULB5-1430-S	\$1321.20	\$1401.14		
		36"(914mm)	ULB5-1436-S	1442.87	1522.81		
<b>Laminate — Letter Depth — 6H</b>							
81.625"(2073mm)	14"(356mm)	30"(762mm)	ULB6-1430-S	\$1664.02	\$1743.96		
		36"(914mm)	ULB6-1436-S	1812.54	1892.48		
<b>Laminate — Legal Depth — 2H</b>							
28"(711mm)	16.5"(419mm)	30"(762mm)	ULB2-1730-S	\$1035.51	\$1115.45		
		36"(914mm)	ULB2-1736-S	1079.76	1159.70		
<b>Laminate — Legal Depth — 3H</b>							
41.625"(1057mm)	16.5"(419mm)	30"(762mm)	ULB3-1730-S	\$1093.85	\$1173.79		
		36"(914mm)	ULB3-1736-S	1164.96	1244.90		
<b>Laminate — Legal Depth — 4H</b>							
55.3125"(1405mm)	16.5"(419mm)	30"(762mm)	ULB4-1730-S	\$1138.27	\$1218.21		
		36"(914mm)	ULB4-1736-S	1234.65	1314.59		
<b>Laminate — Legal Depth — 5H</b>							
69"(1753mm)	16.5"(419mm)	30"(762mm)	ULB5-1730-S	\$1442.87	\$1522.81		
		36"(914mm)	ULB5-1736-S	1564.54	1644.48		
<b>Laminate — Legal Depth — 6H</b>							
81.625"(2073mm)	16.5"(419mm)	30"(762mm)	ULB6-1730-S	\$1812.54	\$1892.48		
		36"(914mm)	ULB6-1736-S	1961.06	2041.00		
<b>Wood — Letter Depth — 2H</b>							
28"(711mm)	14"(356mm)	30"(762mm)	UXB2-1430-S			\$1964.13	\$2228.61
		36"(914mm)	UXB2-1436-S			2008.38	2276.89
<b>Wood — Letter Depth — 3H</b>							
41.625"(1057mm)	14"(356mm)	30"(762mm)	UXB3-1430-S			\$2464.72	\$2729.20
		36"(914mm)	UXB3-1436-S			2535.83	2804.34
<b>Wood — Letter Depth — 4H</b>							
55.3125"(1405mm)	14"(356mm)	30"(762mm)	UXB4-1430-S			\$2965.32	\$3229.80
		36"(914mm)	UXB4-1436-S			3061.70	3330.21
<b>Wood — Letter Depth — 5H</b>							
69"(1753mm)	14"(356mm)	30"(762mm)	UXB5-1430-S			\$3461.85	\$3726.33
		36"(914mm)	UXB5-1436-S			3583.52	3852.03
<b>Wood — Letter Depth — 6H</b>							
81.625"(2073mm)	14"(356mm)	30"(762mm)	UXB6-1430-S			\$3962.43	\$4226.91
		36"(914mm)	UXB6-1436-S			4110.95	4379.46
<b>Wood — Legal Depth — 2H</b>							
28"(711mm)	16.5"(419mm)	30"(762mm)	UXB2-1730-S			\$2008.38	\$2276.89
		36"(914mm)	UXB2-1736-S			2052.63	2325.17
<b>Wood — Legal Depth — 3H</b>							
41.625"(1057mm)	16.5"(419mm)	30"(762mm)	UXB3-1730-S			\$2535.83	\$2804.34
		36"(914mm)	UXB3-1736-S			2606.94	2879.48
<b>Wood — Legal Depth — 4H</b>							
55.3125"(1405mm)	16.5"(419mm)	30"(762mm)	UXB4-1730-S			\$3061.70	\$3330.21
		36"(914mm)	UXB4-1736-S			3158.08	3430.62
<b>Wood — Legal Depth — 5H</b>							
69"(1753mm)	16.5"(419mm)	30"(762mm)	UXB5-1730-S			\$3583.52	\$3852.03
		36"(914mm)	UXB5-1736-S			3705.19	3977.73
<b>Wood — Legal Depth — 6H</b>							
81.625"(2073mm)	16.5"(419mm)	30"(762mm)	UXB6-1730-S			\$4110.95	\$4379.46
		36"(914mm)	UXB6-1736-S			4259.47	4532.01

# Masters Series

## Tables

### Table — Round

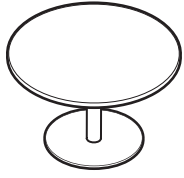

XZAM-1S

Height	Diameter	Number ①	Laminate A	B	Wood Group A	Group B
<b>Laminate</b>						
29.25"(743mm)	30"(762mm)	XLAM-3000-JS	\$2026.89	\$2113.77		
	36"(914mm)	XLAM-3600-JS	2226.52	2309.55		
	42"(1067mm)	XLAM-4200-JS	2461.41	2539.89		
	48"(1219mm)	XLAM-4800-JS	2731.56	2804.79		
<b>Wood</b>						
29.25"(743mm)	30"(762mm)	XZAM-3000- S			\$2171.65	\$2316.34
	36"(914mm)	XZAM-3600- S			2458.18	2619.40
	42"(1067mm)	XZAM-4200- S			2790.45	2970.86
	48"(1219mm)	XZAM-4800- S			3168.46	3370.72

#### Features

- Includes round top and 27"(686mm) disc base.
- 30"(762mm) and 36"(914mm) includes 21"(533mm) disc base.
- 42"(1067mm) and 48"(1219mm) includes 27"(686mm) disc base.
- Fixed height base: 29.25"(743mm).
- 1.1875"(30mm) thick laminate worksurface with edgeband.
- 1.1875"(30mm) thick wood worksurface with a choice of profiled edge (Square, Bevel, Radius or Traditional). Double-cut veneers available with Square 3mm Radius edge only.

#### To Order, Specify:

- 1) Product number, including:

#### ① Edge Option:

Wood:

- 1 Square
- 5 Bevel, add \$278.62 list
- 6 Radius, add \$278.62 list
- 7 Traditional, add \$278.62 list

- 2) Finish code (laminate or wood).
- 3) Laminate edge trim color (if laminate specified).
- 4) Trim code for disc base.

**Note:** \$23.12 upcharge (list) for metallic or accent trim colors.

Height	Depth	Width	Number ①	Laminate A	B	Wood Group A	Wood Group B
<b>Laminate</b>							
29.25"(743mm)	30"(762mm)	30"(762mm)	XLAS-3030-JS	\$2161.62	\$2254.23	N/A	N/A
	36"(914mm)	36"(914mm)	XLAS-3636-JS	2374.69	2463.23	N/A	N/A
	42"(1067mm)	42"(1067mm)	XLAS-4242-JS	2625.36	2709.09	N/A	N/A
<b>Wood</b>							
29.25"(743mm)	30"(762mm)	30"(762mm)	XZAS-3030- S	N/A	N/A	\$2609.06	\$2770.26
	36"(914mm)	36"(914mm)	XZAS-3636- S	N/A	N/A	2954.70	3136.04
	42"(1067mm)	42"(1067mm)	XZAS-4242- S	N/A	N/A	3345.60	3549.74

### Square Tables

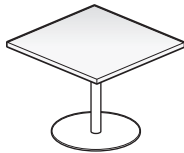

XLAS-3030  
XZAS-3030

#### Features

- Includes square top and 27"(686mm) disc base.
- Includes 1.1875"(36mm) thick laminate worksurface with 3mm edgeband.
- Includes 1.1875"(36mm) thick wood worksurface with a choice of profiled edge (Square, Bevel, Radius or Traditional). **Double-cut veneers available with Square 3mm edge only.**

#### To Order, Specify:

- 1) Product number, including:

#### ① Edge Option:

Wood:





- 1 Square
- 5 Bevel, add \$363.78 list
- 6 Radius, add \$363.78 list
- 7 Traditional, add \$363.78 list

- 2) Finish code (laminate or wood).
- 3) Laminate edge trim color (if laminate specified).
- 4) Trim code for disc base.

**Note:** \$23.12 upcharge (list) for Metallic and accent trim colors.

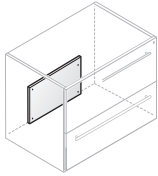
## Masters Series

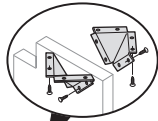
Accessories

	Height	Width	Number	Price	
<b>Counterweight</b>  UXWA Class RA – SIN 33721; Discount Group IX	18.75"(476mm)	14"(356mm)	UXWA-1914	\$78.99	
<b>Features</b> <ul style="list-style-type: none"> <li>Includes counterweight and attachment hardware.</li> <li>Standard in painted black steel only</li> </ul>		<b>To Order, Specify:</b> <ul style="list-style-type: none"> <li>1) Product number. (No finish specification required.)</li> </ul>			
<b>Specification Tips</b> <ul style="list-style-type: none"> <li>Required for use with 1H, 1.5H and 2H attached lateral file with finished back and credenza top in a free-standing application.</li> <li>Not required for 4H, 5H or 6H freestanding lateral file cabinets.</li> </ul>					
<b>Flush Mount Plate</b>  ZUBF-0000-PN Class CA – SIN 33721; Discount Group VIII	Width	Depth	Number	Price	
	4"(102mm)	3"(76mm)	ZUBF-0000-PN	\$35.85	
<b>Features</b> <ul style="list-style-type: none"> <li>Includes one bracket and mounting screws.</li> <li>Mounts straight end of convergent worksurfaces or conference end worksurfaces to panel-hung worksurfaces.</li> <li>Standard in charcoal finish color only.</li> <li>Provides attachment of two worksurfaces at the same height.</li> </ul>		<b>To Order, Specify:</b> <ul style="list-style-type: none"> <li>1) Product number. (No finish specification required.)</li> </ul>			
<b>Tetra Bracket</b>   W111-5298 Open Market Item	Height	Width	Depth	Number	Price
	3.25"(83mm)	6.5"(165mm)	3.75"(95mm)	W111-5298	\$45.60
<b>Features</b> <ul style="list-style-type: none"> <li>Includes bracket and hardware.</li> <li>Standard in black steel only.</li> </ul>		<b>To Order, Specify:</b> <ul style="list-style-type: none"> <li>1) Product number. (No finish specification required.)</li> </ul>			
<b>Specification Tip</b> <ul style="list-style-type: none"> <li>Used to connect end panel to worksurface.</li> </ul>					

# Masters Series

## Accessories

	Height	Depth	Width	Number <sup>1</sup>	Price
<b>Center Drawer</b>	1.875"(48mm)	17.5"(445mm)	24"(610mm)	UXCD-1824-■	<b>\$642.41</b>

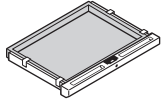

UXCD

Class RA – SIN 33721;  
Discount Group IX

### Features

- Center drawer includes attachment hardware.
- Hardwood front rail with routed pencil channels.
- Drawer body is black miterfold.
- Optional lock available in black or chrome.
- For lock options, refer to Lock Program section of the Accessories Price List.
- Field installation required.

### To Order, Specify:

- 1) Product number, including:

#### **1** Lock Option:

- N** No Lock
- L** Lock, add **\$82.83** list

- 2) Wood finish - Grade B Veneers only available.
- 3) Trim color for lock plug.

### Specification Tip

- For use under worksurface of single pedestal desk, double pedestal desk, convergent D-top, convergent P-top, desk shell, credenza shell and credenzas with pedestals.

	Letter Width				Price
<b>Pencil Tray</b>	1.25"(32mm)	5.5"(140mm)	12.875"(327mm)	JPTA-6	<b>\$55.79</b>
	1.25"(32mm)	5.5"(140mm)	16.28125"(414mm)	JPTA-9	<b>\$53.41</b>

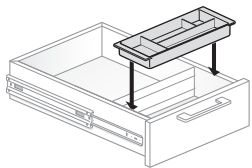

JPTA-6

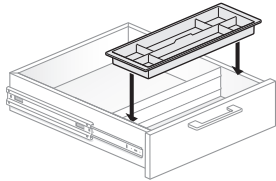

JPTA-9

Class FP – SIN 33721;  
Discount Group XII

### Features

- Includes one black tray.
- Suspends from sides of 6"(152mm) drawer and slides for drawer access.

### To Order, Specify:

- 1) Product number.  
(No finish specification required.)

	Width	Number	Price
<b>File Bars</b>	30"(762mm)	UXAH-0030	<b>\$74.35</b>
	36"(914mm)	UXAH-0036	<b>74.35</b>
	42"(1067mm)	UXAH-0042	<b>74.35</b>

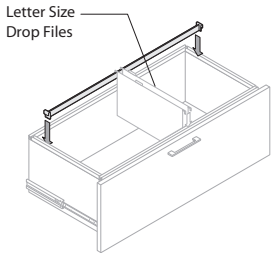

UXAH

Class YA — SIN 33721;  
Discount Group XIII

### Features

- Includes one side-to-side hanging bar.
- Allows for side-to-side letter filing in lateral file drawer.
- Standard in black finish color only.

### To Order, Specify:

- 1) Product number.  
(No finish specification required.)

## Masters Series

Accessories

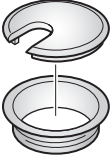
	Height	Inside Diameter	Outside Diameter	Number	Price
<b>Grommet</b>	.625"(16mm)	1.75"(44mm)	2"(51mm)	UXAG-0002	\$47.39
	<b>Features</b>		<b>To Order, Specify:</b>		
	<ul style="list-style-type: none"> <li>Includes one cover.</li> <li>Must be field-installed; requires 1.75"(44mm) field drilled hole.</li> </ul>		<ol style="list-style-type: none"> <li>Product number.</li> <li>Trim color: black or chrome.</li> </ol>		
	<b>Specification Tip</b>		<b>Note:</b> \$44.25 upcharge (list) for chrome.		
	<ul style="list-style-type: none"> <li>Available in black or satin chrome only.</li> </ul>				
UXAG-0002					

	Height	Diameter	Number	Price	
<b>Column Base</b>					
	Painted	28"(711mm)	4"(102mm)	XZEC-2804-NGB	\$312.84
	Chrome	28"(711mm)	4"(102mm)	XZEC-2804-NGC	699.80
	<b>Features</b>		<b>To Order, Specify:</b>		
	<ul style="list-style-type: none"> <li>Includes 4"(102mm) diameter column, 6"(152mm) diameter mounting plate, glide and attachment hardware.</li> <li>Allows for 3"(76mm) adjustment.</li> </ul>		<ol style="list-style-type: none"> <li>Product number.</li> <li>Trim color for Painted Column Base.</li> </ol>		
	<b>Specification Tip</b>				
	<ul style="list-style-type: none"> <li>For use to provide support to separately specified modular worksurfaces; recommended for use with extended corner and radius ender worksurfaces.</li> </ul>				
XZEC-NGB					

# Masters Series — Finish Matrix

## Wood Finish/Color Legend





Because of the natural properties of wood, variations of grain and finish color can be expected. Haworth carefully selects materials used in the manufacturing of products to ensure consistent and acceptable color.

Wood is susceptible to color change from exposure to UV rays. Haworth controls this by using surface finishes to reduce color change. However, change may be more evident in light-colored finishes.

All Haworth Wood Casegoods receive the Haworth EcoShield™ water-based, UV cured finish, except for Suite which receives a hand-applied, water-based finish.

EcoShield and hand-applied, water-based finished products are not designed to go together and are not recommended for use within the same space.

Masters Series has a water-based, UV cured EcoShield finish.

Wood Group	Veneer Type	Variety	Cutting Technique	Surface	Matching Technique	Grain Direction	Finish Name/Color	Specification Number
						Drawer/Door Front		
	Double Cut	Obeche	Double Cut	Open Pore	N/A	Vertical	Applegate	2P-RL
							Dune	WE-RD
							Ebony	WJ-RE
							Echo	2N-RL
							Melba	WE-RT
	Natural Double Cut	Walnut	Double Cut	Open Pore	N/A	Vertical	Walnut Grove*	CQ-WG
	Natural	Cherry	Plain Sliced	Semi-Open Pore	Book Rotate on Tops Slip Match All Other Surfaces	Vertical	Amber on Cherry	VC-CA1
							American on Cherry	VC-W23
							Caramel Cherry	VC-W33
							Heritage Cherry	VC-W30
							Pacific Cherry	VC-W32
	Natural	Maple	Plain Sliced	Semi-Open Pore	Book Rotate on Tops Slip Match All Other Surfaces	Vertical	Light Maple	VP-LM
							Natural Maple	VP-N
	Natural	Walnut	Plain Sliced	Open Pore	Book Rotate on Tops Slip Match All Other Surfaces	Vertical	Espresso on Walnut	VR-W15
							Retro on Walnut	VR-W31
	Quarter Cut	Anegre	Quarter Cut	Semi-Open Pore	N/A	Vertical	Espresso on QC Anegre	NP-W15
	Quarter Cut	Maple	Quarter Cut	Semi-Open Pore	N/A	Vertical	Natural QC Maple	NM-N
	Quarter Cut	Walnut	Quarter Cut	Open Pore	N/A	Vertical	Espresso on QC Walnut	NW-W15
Clear on QC Walnut							NW-W35	
Retro on QC Walnut							NW-W31	
	Rift Cut	White Oak	Rift Cut	Open Pore	N/A	Vertical	Clear on Rift Cut White Oak	NR-W35
							Espresso on Rift Cut White Oak	NR-W15
							Mocha on Rift Cut White Oak	NR-W40

\*Finger pull (F) and profiled edges available in Walnut Grove and Wood Group B only.

### Forest Stewardship Council®

**(FSC®) Statement:** In our continuing support of sustainable forestry and responsible purchasing, Haworth North America is offering FSC certified wood products at no up-charge. By providing FSC certified material, Haworth is supporting our client's green building goals and demonstrating our collective commitment to source materials more sustainably.

Haworth will provide to you the necessary FSC-certified paperwork with your shipment. For more information, FAQs, and a complete FSC product list (including product exceptions), go to the Library and search FSC.

Haworth FSC Trademark License  
#FSC-C002821

### Alert:

These materials are current, however they are being considered for future obsolescence due to low volume.

- Brindle VJ-W42
- Butternut 2R-RL
- Golden NP-W08
- Light NP-W07
- Medium NX-U
- Naturally Walnut VR-W12
- Sand VP-AD
- Wenge WC-RW

## Masters Series — Finish Matrix

	Grommets and Lock Plugs	Column Bases/ Disc Bases/ Stanchions	Glass Door Frames, Table Legs, Bar Pulls	Surface Materials	Edge Trim
<b>Trim Colors</b>					
Black	LR-BL				
Chrome	LR-BP				
<b>Paint — Grade A</b>					
Beige		TR-R	TR-R		
Chalk		TR-AK	TR-AK		
Charcoal		TR-K	TR-K		
Cocoa		TR-C1	TR-C1		
Graphite		TR-J	TR-J		
Gray Tone		TR-G	TR-G		
Putty		TR-AA	TR-AA		
Smoke		TR-E	TR-E		
Smooth Plaster		TR-PLS	TR-PLS		
Snow		TR-FM	TR-FM		
<b>Smooth Paint — Grade A*</b>					
Black				LN-F	
<b>Textured Paint — Grade A</b>					
Grout		TR-TG	TR-TG		
Pitch		TR-TF	TR-TF		
Plaster		TR-TW	TR-TW		
<b>Smooth Paint — Grade B</b>					
Blue Jay				TR-1G	
Brownstone				TR-1R	
Chartreuse				TR-CTS	
Night				TR-1N	
Park				TR-1Q	
Rusty Red				TR-RR	
Sable				TR-1M	
Sky Blue				TR-1J	
Terra				TR-1H	
Wren				TR-1K	
<b>Metallic Paint — Grade B</b>					
Champagne		TR-MC	TR-MC		
Dark Bronze		TR-DM	TR-DM		
Silver		TR-LE	TR-LE		
<b>Textured Metallic Paint — Grade B</b>					
Hellenic		TR-HE	TR-HE		
<b>Laminate - Solid — Grade A</b>					
Beige				H-34	HP-34
Chalk				H-AK	HP-AK
Charcoal				H-8J	HP-8J
Graphite				H-3J	HP-3J
Gray Tone				H-62	HP-62
Linen				H-WL	HP-WL
Platinum				H-3P	HP-3P
Smoke				H-3E	HP-3E
Putty				H-AA	HP-AA
<b>Laminate - Wood — Grade A</b>					
Maple				H-AE	HP-AE
<b>Laminate - Patterned — Grade A</b>					
Linen Casual				H-P1	HP-P1
Linen Classic				H-P2	HP-P2
Linen Crisp				H-P3	HP-P3
Linen Flax				H-P4	HP-P4
<b>Laminate - Premium Wood Grain — Grade B</b>					
Brazilwood				H-KA	HP-KA
Colombian Walnut				H-KG	HP-KG
Field Elm				H-KP	HP-KP
Grey Elm				H-KN	HP-KN
Landmark Wood				H-KM	HP-KM
Neo Walnut				H-KL	HP-KL
New Age Oak				H-KC	HP-KC
Phantom Ecu				H-KR	HP-KR
Phantom Pearl				H-LS	HP-LS
River Cherry				H-KD	HP-KD
Williamsburg Cherry				H-KF	HP-KF

## Masters Series — Finish Matrix

Glass Finish Group	Glass Finishes	Finish Code
A	Clear Tempered	4G-1C
C	Satin Etch Tempered	4G-E21
D	Diffused - Laminated	4G-L01
F	White Back-painted Low Iron Tempered	4G-SLW

\*Paint B metallic while not recommended is available and can be priced through Lynx.

**Alert:**

These materials are current, however they are being considered for future obsolescence due to low volume.

**Laminate:**

Amber Cherry H-AM  
 Medium Cherry H-AD

**Trims:**

Cement TR-TY  
 Chartreuse TR-CTS



# Fabrics/Color Legend

## Vertical Fabrics

### Grade A

Chevron (6X)  
Etch (35)  
Highlands (L6)  
Striae (C1)  
Tailored (PY)

### Grade B

Blanket (4HV)  
Camp (33)  
Classic (L5)  
Fields (34)  
Hobson (3JV)  
Hue (6)  
Novelty (3LV)  
Peca (32)  
Ritz (PV)  
Shimmer (WS)

### Grade C

Birds Nest (PH)  
Sisal (SW)  
Thorman (45)

## Seating Fabrics

### Grade A

Tellure (3A)

### Grade D

Tangram (LV)

**ALERT:** These materials are current, however they are being considered for future obsolescence due to low volume.

#### **Haworth+**

For information on the Haworth+ alliance program, including images and product availability, please refer to:  
Haworth.com > Surface Collection > Haworth+ Library

#### **Customer's Own Material (COM)**

For general Customer's Own Material (COM) information including processes and forms, please refer to:  
Haworth.com > Surface Collection > Resources > COM

For information on approved COM's, please refer to:  
Haworth.com > Surface Collection > COM Library

\* For most current finish and fabric availability please reference [surfaces.haworth.com](https://surfaces.haworth.com).

## Masters Series — COM Yardage Requirements

### Masters Series Tackboard Fabric Usage

Nominal (Inches)		66 Inch Roll (Linear Yards)			54 Inch Roll (Linear Yards)		
Height	Width	Directional	Railroad	Non-directional	Directional	Railroad	Non-directional
<b>Fabric Tackboards for Vertical Storage Units</b>							
22" <sub>(559mm)</sub>	28" <sub>(711mm)</sub>	0.475	0.713		0.475	0.713	
	30" <sub>(762mm)</sub>	0.509	0.764		0.509	0.764	
	36" <sub>(914mm)</sub>	0.611	0.917		0.611	0.917	
	42" <sub>(1067mm)</sub>	0.713	1.069		0.713	1.069	
	48" <sub>(1219mm)</sub>	0.815	1.222		0.815	1.222	
	51" <sub>(1295mm)</sub>	0.866	1.299		0.866	1.299	
	57" <sub>(1448mm)</sub>	0.968	1.452		N/A	N/A	
	63" <sub>(1600mm)</sub>	1.069	1.604		N/A	N/A	
	69" <sub>(1753mm)</sub>	1.171	1.757		N/A	N/A	
	75" <sub>(1905mm)</sub>	1.273	1.910		N/A	N/A	
	81" <sub>(2057mm)</sub>	1.375	2.063		N/A	N/A	
	87" <sub>(2210mm)</sub>	1.477	2.215		N/A	N/A	
	93" <sub>(2362mm)</sub>	1.579	2.368		N/A	N/A	
<b>Fabric Tackboards with Slat Rail for Vertical Storage Units</b>							
22" <sub>(559mm)</sub>	28" <sub>(711mm)</sub>	0.302	0.454		0.302	0.454	
	30" <sub>(762mm)</sub>	0.324	0.486		0.324	0.486	
	36" <sub>(914mm)</sub>	0.389	0.583		0.389	0.583	
	42" <sub>(1067mm)</sub>	0.454	0.681		0.454	0.681	
	48" <sub>(1219mm)</sub>	0.519	0.778		0.519	0.778	
	51" <sub>(1295mm)</sub>	0.551	0.826		0.551	0.826	
	57" <sub>(1448mm)</sub>	0.616	0.924		N/A	N/A	
	63" <sub>(1600mm)</sub>	0.681	1.021		N/A	N/A	
	69" <sub>(1753mm)</sub>	0.745	1.118		N/A	N/A	
	75" <sub>(1905mm)</sub>	0.810	1.215		N/A	N/A	
	81" <sub>(2057mm)</sub>	0.875	1.313		N/A	N/A	
	87" <sub>(2210mm)</sub>	0.940	1.410		N/A	N/A	
	93" <sub>(2362mm)</sub>	1.005	1.507		N/A	N/A	
<b>Fabric Tackboards for Overhead Storage Units</b>							
24" <sub>(610mm)</sub>	30" <sub>(762mm)</sub>	0.556	0.833		0.556	0.833	
	31" <sub>(787mm)</sub>	0.574	0.861		0.574	0.861	
	36" <sub>(914mm)</sub>	0.667	1.000		0.667	1.000	
	37" <sub>(940mm)</sub>	0.685	1.028		0.685	1.028	
	42" <sub>(1067mm)</sub>	0.778	1.167		0.778	1.167	
	48" <sub>(1219mm)</sub>	0.889	1.333		0.889	1.333	
	54" <sub>(1372mm)</sub>	1.000	1.500		N/A	N/A	
	60" <sub>(1524mm)</sub>	1.110	1.667		N/A	N/A	
	66" <sub>(1676mm)</sub>	1.222	1.833		N/A	N/A	
	72" <sub>(1829mm)</sub>	1.333	2.000		N/A	N/A	
	78" <sub>(1981mm)</sub>	1.444	2.167		N/A	N/A	
	84" <sub>(2134mm)</sub>	1.556	2.333		N/A	N/A	
	90" <sub>(2286mm)</sub>	1.667	2.500		N/A	N/A	
	96" <sub>(2438mm)</sub>	1.778	2.667		N/A	N/A	

## Masters Series — COM Yardage Requirements

**Masters Series Tackboard Fabric Usage, (continued)**

Nominal (Inches)		66 Inch Roll (Linear Yards)			54 Inch Roll (Linear Yards)		
Height	Width	Directional	Railroad	Non-directional	Directional	Railroad	Non-directional
<b>Fabric Tackboards with Slat Rail for Overhead Storage Units</b>							
24" <sub>(610mm)</sub>	30" <sub>(762mm)</sub>	0.370	0.556		0.370	0.556	
	31" <sub>(787mm)</sub>	0.383	0.574		0.383	0.574	
	36" <sub>(914mm)</sub>	0.444	0.667		0.444	0.667	
	37" <sub>(940mm)</sub>	0.457	0.685		0.457	0.685	
	42" <sub>(1067mm)</sub>	0.519	0.778		0.519	0.778	
	48" <sub>(1219mm)</sub>	0.593	0.889		0.593	0.889	
	54" <sub>(1372mm)</sub>	0.667	1.000		N/A	N/A	
	60" <sub>(1524mm)</sub>	0.741	1.111		N/A	N/A	
	66" <sub>(1676mm)</sub>	0.815	1.222		N/A	N/A	
	72" <sub>(1829mm)</sub>	0.889	1.333		N/A	N/A	
	78" <sub>(1981mm)</sub>	0.963	1.444		N/A	N/A	
	84" <sub>(2134mm)</sub>	1.037	1.556		N/A	N/A	
	90" <sub>(2286mm)</sub>	1.111	1.667		N/A	N/A	
	96" <sub>(2438mm)</sub>	1.185	1.778		N/A	N/A	
<b>Fabric Tackboards for Reception Stations</b>							
12.5" <sub>(318mm)</sub>	72" <sub>(1829mm)</sub>	0.722	1.083		N/A	N/A	
	84" <sub>(2134mm)</sub>	0.843	1.264		N/A	N/A	

Note: Tackboards over 60"(1524mm) wide are shipped in two equal pieces.

# Index

Products are listed alphabetically in this index by alpha-numeric prefix/suffix codes.

<b>Product Code</b>	<b>Product Description</b>	<b>Page</b>
JPTA-6	Masters Series – Pencil Tray	180
JPTA-9	Masters Series – Pencil Tray	180
MTSV	Masters Series – Tackboards — Vertical Storage Units — Fabric and Slat Rail	90
MTSW	Masters Series – Fabric and Slat Rail	124
MTSW	Masters Series – Tackboards — Wall Mount Overhead Storage Units — Fabric and Slat Rail	123
MTVD	Masters Series – Tackboards — Vertical Storage Units — Fabric	90
MTWD	Masters Series – Fabric Tackboards	124
MTWD	Masters Series – Tackboards — Wall Mount Overhead Storage Units — Fabric	123
UFXS	Masters Series – Adaptable Modesty Panel	136
ULB2-S	Masters Series – Bookcase — 2H, 3H, 4H, 5H and 6H	176
ULB3-S	Masters Series – Bookcase — 2H, 3H, 4H, 5H and 6H	176
ULB4-S	Masters Series – Bookcase — 2H, 3H, 4H, 5H and 6H	176
ULB5-S	Masters Series – Bookcase — 2H, 3H, 4H, 5H and 6H	176
ULB6-S	Masters Series – Bookcase — 2H, 3H, 4H, 5H and 6H	176
ULLD-SN	Masters Series – Overhead Storage Units — 1.5H with Glass Sliding Door	118
ULLD-SN	Masters Series – Overhead Storage Units — 1H with Glass Sliding Door	116
ULLD-SN	Masters Series – Overhead Storage Units — 2H with Glass Sliding Door	120
ULLL-SN	Masters Series – Overhead Storage Units — 1.5H with Glass Sliding Door	118
ULLL-SN	Masters Series – Overhead Storage Units — 1H with Glass Sliding Door	116
ULLL-SN	Masters Series – Overhead Storage Units — 2H with Glass Sliding Door	120
ULMD-SL	Masters Series – Overhead Storage Units — 1.5H with Glass Hinged Doors	112
ULMD-SL	Masters Series – Overhead Storage Units — 1H with Glass Hinged Doors	110
ULMD-SL	Masters Series – Overhead Storage Units — 2H with Glass Hinged Doors	114
ULMD-SN	Masters Series – Overhead Storage Units — 1.5H with Glass Hinged Doors	112
ULMD-SN	Masters Series – Overhead Storage Units — 1H with Glass Hinged Doors	110
ULMD-SN	Masters Series – Overhead Storage Units — 2H with Glass Hinged Doors	114
ULML-SL	Masters Series – Overhead Storage Units — 1.5H with Glass Hinged Doors	112
ULML-SL	Masters Series – Overhead Storage Units — 1H with Glass Hinged Doors	110
ULML-SL	Masters Series – Overhead Storage Units — 2H with Glass Hinged Doors	114
ULML-SN	Masters Series – Overhead Storage Units — 1.5H with Glass Hinged Doors	112
ULML-SN	Masters Series – Overhead Storage Units — 1H with Glass Hinged Doors	110
ULML-SN	Masters Series – Overhead Storage Units — 2H with Glass Hinged Doors	114
ULND-SN	Masters Series – Overhead Storage Units — 1H Open	94
ULND-SN	Masters Series – Overhead Storage Units — 2H Open	96
ULNL-SN	Masters Series – Overhead Storage Units — 1H Open	94
ULNL-SN	Masters Series – Overhead Storage Units — 2H Open	96
ULOD-SL	Masters Series – Overhead Storage Units — 1.5H with Hinged Doors	100
ULOD-SL	Masters Series – Overhead Storage Units — 1H with Hinged Doors	98
ULOD-SL	Masters Series – Overhead Storage Units — 2H with Hinged Doors	102
ULOD-SN	Masters Series – Overhead Storage Units — 1.5H with Hinged Doors	100
ULOD-SN	Masters Series – Overhead Storage Units — 1H with Hinged Doors	98
ULOD-SN	Masters Series – Overhead Storage Units — 2H with Hinged Doors	102
ULOL-SL	Masters Series – Overhead Storage Units — 1.5H with Hinged Doors	100
ULOL-SL	Masters Series – Overhead Storage Units — 1H with Hinged Doors	98
ULOL-SL	Masters Series – Overhead Storage Units — 2H with Hinged Doors	102
ULOL-SN	Masters Series – Overhead Storage Units — 1.5H with Hinged Doors	100
ULOL-SN	Masters Series – Overhead Storage Units — 1H with Hinged Doors	98
ULOL-SN	Masters Series – Overhead Storage Units — 2H with Hinged Doors	102
ULRD-SN	Masters Series – Overhead Storage Units — 1.5H with Sliding Door	106
ULRD-SN	Masters Series – Overhead Storage Units — 1H with Sliding Door	104
ULRD-SN	Masters Series – Overhead Storage Units — 2H with Sliding Door	108
ULRL-SN	Masters Series – Overhead Storage Units — 1.5H with Sliding Door	106
ULRL-SN	Masters Series – Overhead Storage Units — 1H with Sliding Door	104

## Index

<b>Product Code</b>	<b>Product Description</b>	<b>Page</b>
ULRL-SN	Masters Series – Overhead Storage Units — 2H with Sliding Door	108
ULSE	Masters Series – Modular Components — End Panel — 2H	138
ULSE	Masters Series – Modular Components — End Panel — 2H	138
ULSL	Masters Series – Modular Components — L-Support Panel	140
ULSL	Masters Series – Modular Components — Partial Depth L-Support Panel — 2H	142
ULSS-S	Masters Series – Modular Components — Mid-Support Panel — 2H	144
ULSX-SN	Masters Series – Modular Components — T-Support Panel — 2H	144
ULWD-1730-NSN	Masters Series – Open Sided Shelf	92
ULWD-2930-NSN	Masters Series – Open Sided Shelf	92
ULWL-1730-NSN	Masters Series – Open Sided Shelf	92
ULWL-2930-NSN	Masters Series – Open Sided Shelf	92
ULXF-SS	Masters Series – Full Overlay Modesty Panel	134
ULXH-SN2	Masters Series – Hinged Modesty Panel	135
ULXS	Masters Series – Adaptable Modesty Panel	136
UXAG-0002	Masters Series – Grommet	181
UXAH	Masters Series – File Bars	180
UXB2-S	Masters Series – Bookcase — 2H, 3H, 4H, 5H and 6H	176
UXB3-S	Masters Series – Bookcase — 2H, 3H, 4H, 5H and 6H	176
UXB4-S	Masters Series – Bookcase — 2H, 3H, 4H, 5H and 6H	176
UXB5-S	Masters Series – Bookcase — 2H, 3H, 4H, 5H and 6H	176
UXB6-S	Masters Series – Bookcase — 2H, 3H, 4H, 5H and 6H	176
UXCD	Masters Series – Center Drawer	180
UXLD-SN	Masters Series – Overhead Storage Units — 1.5H with Glass Sliding Door	118
UXLD-SN	Masters Series – Overhead Storage Units — 1H with Glass Sliding Door	116
UXLD-SN	Masters Series – Overhead Storage Units — 2H with Glass Sliding Door	120
UXLL-SN	Masters Series – Overhead Storage Units — 1.5H with Glass Sliding Door	118
UXLL-SN	Masters Series – Overhead Storage Units — 1H with Glass Sliding Door	116
UXLL-SN	Masters Series – Overhead Storage Units — 2H with Glass Sliding Door	120
UXMD-SL	Masters Series – Overhead Storage Units — 1.5H with Glass Hinged Doors	112
UXMD-SL	Masters Series – Overhead Storage Units — 1H with Glass Hinged Doors	110
UXMD-SL	Masters Series – Overhead Storage Units — 2H with Glass Hinged Doors	114
UXMD-SN	Masters Series – Overhead Storage Units — 1.5H with Glass Hinged Doors	112
UXMD-SN	Masters Series – Overhead Storage Units — 1H with Glass Hinged Doors	110
UXMD-SN	Masters Series – Overhead Storage Units — 2H with Glass Hinged Doors	114
UXML-SL	Masters Series – Overhead Storage Units — 1.5H with Glass Hinged Doors	112
UXML-SL	Masters Series – Overhead Storage Units — 1H with Glass Hinged Doors	110
UXML-SL	Masters Series – Overhead Storage Units — 2H with Glass Hinged Doors	114
UXML-SN	Masters Series – Overhead Storage Units — 1.5H with Glass Hinged Doors	112
UXML-SN	Masters Series – Overhead Storage Units — 1H with Glass Hinged Doors	110
UXML-SN	Masters Series – Overhead Storage Units — 2H with Glass Hinged Doors	114
UXND-SN	Masters Series – Overhead Storage Units — 1H Open	94
UXND-SN	Masters Series – Overhead Storage Units — 2H Open	96
UXNL-SN	Masters Series – Overhead Storage Units — 1H Open	94
UXNL-SN	Masters Series – Overhead Storage Units — 2H Open	96
UXOD-SL	Masters Series – Overhead Storage Units — 1.5H with Hinged Doors	100
UXOD-SL	Masters Series – Overhead Storage Units — 1H with Hinged Doors	98
UXOD-SL	Masters Series – Overhead Storage Units — 2H with Hinged Doors	102
UXOD-SN	Masters Series – Overhead Storage Units — 1.5H with Hinged Doors	100
UXOD-SN	Masters Series – Overhead Storage Units — 1H with Hinged Doors	98
UXOD-SN	Masters Series – Overhead Storage Units — 2H with Hinged Doors	102
UXOL-SL	Masters Series – Overhead Storage Units — 1.5H with Hinged Doors	100
UXOL-SL	Masters Series – Overhead Storage Units — 1H with Hinged Doors	98
UXOL-SL	Masters Series – Overhead Storage Units — 2H with Hinged Doors	102
UXOL-SN	Masters Series – Overhead Storage Units — 1.5H with Hinged Doors	100

# Index

<b>Product Code</b>	<b>Product Description</b>	<b>Page</b>
UXOL-SN	Masters Series – Overhead Storage Units — 1H with Hinged Doors	.98
UXOL-SN	Masters Series – Overhead Storage Units — 2H with Hinged Doors	.102
UXRD-SN	Masters Series – Overhead Storage Units — 1.5H with Sliding Door	.106
UXRD-SN	Masters Series – Overhead Storage Units — 1H with Sliding Door	.104
UXRD-SN	Masters Series – Overhead Storage Units — 2H with Sliding Door	.108
UXRL-SN	Masters Series – Overhead Storage Units — 1.5H with Sliding Door	.106
UXRL-SN	Masters Series – Overhead Storage Units — 1H with Sliding Door	.104
UXRL-SN	Masters Series – Overhead Storage Units — 2H with Sliding Door	.108
UXSE	Masters Series – Modular Components — End Panel — 2H	.138
UXSE	Masters Series – Modular Components — End Panel — 2H	.138
UXSL	Masters Series – Modular Components — L-Support Panel	.140
UXSL	Masters Series – Modular Components — Partial Depth L-Support Panel — 2H	.142
UXSS-S	Masters Series – Modular Components — Mid-Support Panel — 2H	.144
UXSX-SN	Masters Series – Modular Components — T-Support Panel — 2H	.144
UXWA	Masters Series – Counterweight	.179
UXXF-SS	Masters Series – Full Overlay Modesty Panel	.134
UXXH-SN2	Masters Series – Hinged Modesty Panel	.135
UXXS	Masters Series – Adaptable Modesty Panel	.136
W111-5298	Masters Series – Tetra Bracket	.179
X4AD-WL	Masters Series – Personal Storage Tower with F/F/F and Valet	.171
X4AF-WL	Masters Series – Personal Storage Tower with F/F Pedestal and Valet — 5H and 6H	.172
X4CA-2348	Masters Series – 2H Attached Sliding Door Storage Unit	.158
X4CB-2348	Masters Series – 1.5H Attached Sliding Door Storage Unit for use with Convergent Worktop	.160
X4CD-SW	Masters Series – Stack-On Storage Cabinet with Hinged Doors	.126
X4CL-SW	Masters Series – Stack-On Storage Cabinet with Hinged Doors	.126
X4F1-LW	Masters Series – 1H and 1.5H High and 2H Attached Lateral Files	.150
X4F3-LW	Masters Series – Freestanding Lateral File – 3H and 4H	.166
X4F4-LW	Masters Series – Freestanding Lateral File – 3H and 4H	.166
X4F5-LW	Masters Series – Freestanding Lateral File – 5H and 6H	.167
X4F6-LW	Masters Series – Freestanding Lateral File – 5H and 6H	.167
X4FA-LW	Masters Series – 1H and 1.5H High and 2H Attached Lateral Files	.150
X4FA-LW	Masters Series – 1H and 1.5H High and 2H Attached Lateral Files	.150
X4FA-LW	Masters Series – 1H and 1.5H High and 2H Attached Lateral Files	.150
X4FB-LW	Masters Series – 1H and 1.5H High and 2H Attached Lateral Files	.150
X4FV-LW	Masters Series – 1.5H Attached Lateral File with Open Shelf	.148
X4H2-LW	Masters Series – 2H Storage Unit with Doors	.155
X4H3-LW	Masters Series – 3H Freestanding Storage Unit with Hinged Doors	.165
X4JD-ST	Masters Series – Stack-On Storage Cabinet with Glass Doors	.127
X4JL-ST	Masters Series – Stack-On Storage Cabinet with Glass Doors	.127
X4KD-SN	Masters Series – Stack-On Bookcase	.125
X4KL-SN	Masters Series – Stack-On Bookcase	.125
X4LD-NT	Masters Series – Vertical Storage Unit — 1H with Glass Sliding Door	.86
X4LD-NT	Masters Series – Vertical Storage Unit — 2H with Glass Sliding Door	.88
X4LL-NT	Masters Series – Vertical Storage Unit — 1H with Glass Sliding Door	.86
X4LL-NT	Masters Series – Vertical Storage Unit — 2H with Glass Sliding Door	.88
X4M5-LW	Masters Series – Combination Unit — 5H and 6H	.168
X4M6-LW	Masters Series – Combination Unit — 5H and 6H	.168
X4N1-NN	Masters Series – 1H and 2H Attached Storage Units	.152
X4N2-NN	Masters Series – 1H and 2H Attached Storage Units	.152
X4N3-NN	Masters Series – 3H Open Storage Unit	.164
X4PA-NW	Masters Series – Attached Pedestals	.145
X4PA-YW	Masters Series – Attached Pedestals	.145
X4PB-1860	Masters Series – 1.5H Attached Storage for use with Convergent Worktop — Open Unit	.154
X4PM-BW	Masters Series – Mobile Pedestal	.146

## Index

<b>Product Code</b>	<b>Product Description</b>	<b>Page</b>
X4RD-NW	Masters Series – Vertical Storage Unit — 1H with Sliding Door	.78
X4RD-NW	Masters Series – Vertical Storage Unit — 2H with Sliding Door	.80
X4RL-NW	Masters Series – Vertical Storage Unit — 1H with Sliding Door	.78
X4RL-NW	Masters Series – Vertical Storage Unit — 2H with Sliding Door	.80
X4SA-1848	Masters Series – 2H Attached Sliding Door Storage Unit	.162
X4SA-1848	Masters Series – 2H Attached Sliding Door Storage Unit	.162
X4SB-1848	Masters Series – 1.5H Attached Sliding Door Storage Unit	.156
X4SB-1848	Masters Series – 1.5H Attached Sliding Door Storage Unit	.156
X4SD-LT	Masters Series – Vertical Storage Unit — 1H with Glass Hinged Doors	.82
X4SD-LT	Masters Series – Vertical Storage Unit — 2H with Glass Hinged Doors	.84
X4SD-NT	Masters Series – Vertical Storage Unit — 1H with Glass Hinged Doors	.82
X4SD-NT	Masters Series – Vertical Storage Unit — 2H with Glass Hinged Doors	.84
X4SL-LT	Masters Series – Vertical Storage Unit — 1H with Glass Hinged Doors	.82
X4SL-LT	Masters Series – Vertical Storage Unit — 2H with Glass Hinged Doors	.84
X4SL-NT	Masters Series – Vertical Storage Unit — 1H with Glass Hinged Doors	.82
X4SL-NT	Masters Series – Vertical Storage Unit — 2H with Glass Hinged Doors	.84
X4TR	Masters Series – Tackboards — Reception Station L-Shaped and U-Shaped	.129
X4UD-NN	Masters Series – Vertical Storage Unit — 1H Open	.70
X4UD-NN	Masters Series – Vertical Storage Unit — 2H Open	.72
X4UL-NN	Masters Series – Vertical Storage Unit — 1H Open	.70
X4UL-NN	Masters Series – Vertical Storage Unit — 2H Open	.72
X4VD-LW	Masters Series – Vertical Storage Unit — 1H with Hinged Doors	.74
X4VD-LW	Masters Series – Vertical Storage Unit — 2H with Hinged Doors	.76
X4VD-NW	Masters Series – Vertical Storage Unit — 1H with Hinged Doors	.74
X4VD-NW	Masters Series – Vertical Storage Unit — 2H with Hinged Doors	.76
X4VL-LW	Masters Series – Vertical Storage Unit — 1H with Hinged Doors	.74
X4VL-LW	Masters Series – Vertical Storage Unit — 2H with Hinged Doors	.76
X4VL-NW	Masters Series – Vertical Storage Unit — 1H with Hinged Doors	.74
X4VL-NW	Masters Series – Vertical Storage Unit — 2H with Hinged Doors	.76
X4W5-WL	Masters Series – Wardrobe with Open Unit — 5H and 6H	.169
X4W6-WL	Masters Series – Wardrobe with Open Unit — 5H and 6H	.169
X4X5-LW	Masters Series – Wardrobe with Closed Storage Unit — 5H and 6H	.170
X4X6-LW	Masters Series – Wardrobe with Closed Storage Unit — 5H and 6H	.170
X4Y5-WR	Masters Series – Freestanding Wardrobe Tower — 5H and 6H	.174
X4Y6-WR	Masters Series – Freestanding Wardrobe Tower — 5H and 6H	.174
X4ZF-WR	Masters Series – Storage Tower — 5H and 6H	.173
X5AD-LL	Masters Series – Personal Storage Tower with F/F/F and Valet	.171
X5AF-LL	Masters Series – Personal Storage Tower with F/F Pedestal and Valet — 5H and 6H	.172
X5CA-2348	Masters Series – 2H Attached Sliding Door Storage Unit	.158
X5CB-2348	Masters Series – 1.5H Attached Sliding Door Storage Unit for use with Convergent Worktop	.160
X5CD-SW	Masters Series – Stack-On Storage Cabinet with Hinged Doors	.126
X5CL-SW	Masters Series – Stack-On Storage Cabinet with Hinged Doors	.126
X5F1-LL	Masters Series – 1H and 1.5H High and 2H Attached Lateral Files	.150
X5F3-LL	Masters Series – Freestanding Lateral File – 3H and 4H	.166
X5F4-LL	Masters Series – Freestanding Lateral File – 3H and 4H	.166
X5F5-LL	Masters Series – Freestanding Lateral File – 5H and 6H	.167
X5F6-LL	Masters Series – Freestanding Lateral File – 5H and 6H	.167
X5FA-LL	Masters Series – 1H and 1.5H High and 2H Attached Lateral Files	.150
X5FB-LL	Masters Series – 1H and 1.5H High and 2H Attached Lateral Files	.150
X5FV-LW	Masters Series – 1.5H Attached Lateral File with Open Shelf	.148
X5H2-LL	Masters Series – 2H Storage Unit with Doors	.155
X5H3-LL	Masters Series – 3H Freestanding Storage Unit with Hinged Doors	.165
X5JD-ST	Masters Series – Stack-On Storage Cabinet with Glass Doors	.127
X5JL-ST	Masters Series – Stack-On Storage Cabinet with Glass Doors	.127

## Index

<b>Product Code</b>	<b>Product Description</b>	<b>Page</b>
X5KD-SN	Masters Series – Stack-On Bookcase	.125
X5KL-SN	Masters Series – Stack-On Bookcase	.125
X5LD-NT	Masters Series – Vertical Storage Unit — 1H with Glass Sliding Door	.86
X5LD-NT	Masters Series – Vertical Storage Unit — 2H with Glass Sliding Door	.88
X5LL-NT	Masters Series – Vertical Storage Unit — 1H with Glass Sliding Door	.86
X5LL-NT	Masters Series – Vertical Storage Unit — 2H with Glass Sliding Door	.88
X5M5-LL	Masters Series – Combination Unit — 5H and 6H	.168
X5M6-LL	Masters Series – Combination Unit — 5H and 6H	.168
X5N1-NN	Masters Series – 1H and 2H Attached Storage Units	.152
X5N2-NN	Masters Series – 1H and 2H Attached Storage Units	.152
X5N3-NN	Masters Series – 3H Open Storage Unit	.164
X5PA-NL	Masters Series – Attached Pedestals	.145
X5PA-YL	Masters Series – Attached Pedestals	.145
X5PB-1830	Masters Series – 1.5H Attached Storage for use with Convergent Worktop — Open Unit	.154
X5RD-NL	Masters Series – Vertical Storage Unit — 1H with Sliding Door	.78
X5RD-NL	Masters Series – Vertical Storage Unit — 2H with Sliding Door	.80
X5RL-NL	Masters Series – Vertical Storage Unit — 1H with Sliding Door	.78
X5RL-NL	Masters Series – Vertical Storage Unit — 2H with Sliding Door	.80
X5SA-1848	Masters Series – 2H Attached Sliding Door Storage Unit	.162
X5SA-1848	Masters Series – 2H Attached Sliding Door Storage Unit	.162
X5SB-1848	Masters Series – 1.5H Attached Sliding Door Storage Unit	.156
X5SB-1848	Masters Series – 1.5H Attached Sliding Door Storage Unit	.156
X5SD-LT	Masters Series – Vertical Storage Unit — 1H with Glass Hinged Doors	.82
X5SD-LT	Masters Series – Vertical Storage Unit — 2H with Glass Hinged Doors	.84
X5SD-NT	Masters Series – Vertical Storage Unit — 1H with Glass Hinged Doors	.82
X5SD-NT	Masters Series – Vertical Storage Unit — 2H with Glass Hinged Doors	.84
X5SL-LT	Masters Series – Vertical Storage Unit — 1H with Glass Hinged Doors	.82
X5SL-LT	Masters Series – Vertical Storage Unit — 2H with Glass Hinged Doors	.84
X5SL-NT	Masters Series – Vertical Storage Unit — 1H with Glass Hinged Doors	.82
X5SL-NT	Masters Series – Vertical Storage Unit — 2H with Glass Hinged Doors	.84
X5UD-NN	Masters Series – Vertical Storage Unit — 1H Open	.70
X5UD-NN	Masters Series – Vertical Storage Unit — 2H Open	.72
X5UL-NN	Masters Series – Vertical Storage Unit — 1H Open	.70
X5UL-NN	Masters Series – Vertical Storage Unit — 2H Open	.72
X5VD-LL	Masters Series – Vertical Storage Unit — 1H with Hinged Doors	.74
X5VD-LL	Masters Series – Vertical Storage Unit — 2H with Hinged Doors	.76
X5VD-NL	Masters Series – Vertical Storage Unit — 1H with Hinged Doors	.74
X5VD-NL	Masters Series – Vertical Storage Unit — 2H with Hinged Doors	.76
X5VL-LL	Masters Series – Vertical Storage Unit — 1H with Hinged Doors	.74
X5VL-LL	Masters Series – Vertical Storage Unit — 2H with Hinged Doors	.76
X5VL-NL	Masters Series – Vertical Storage Unit — 1H with Hinged Doors	.74
X5VL-NL	Masters Series – Vertical Storage Unit — 2H with Hinged Doors	.76
X5W5-LL	Masters Series – Wardrobe with Open Unit — 5H and 6H	.169
X5W6-LL	Masters Series – Wardrobe with Open Unit — 5H and 6H	.169
X5X5-LL	Masters Series – Wardrobe with Closed Storage Unit — 5H and 6H	.170
X5X6-LL	Masters Series – Wardrobe with Closed Storage Unit — 5H and 6H	.170
X5Y5-LR	Masters Series – Freestanding Wardrobe Tower — 5H and 6H	.174
X5Y6-LR	Masters Series – Freestanding Wardrobe Tower — 5H and 6H	.174
X5ZF-LR	Masters Series – Storage Tower — 5H and 6H	.173
X7PM-BW	Masters Series – Mobile Pedestal	.146
XLAR-3060	Masters Series – Height Adjustable Table Desk — Rectangular Top — T-Leg Base	.30
XLAR-3072	Masters Series – Table Desk — Rectangular — Hoop Leg	.28
XLAS-3030	Masters Series – Square Tables	.178
XLBF-FS	Masters Series – Bridge	.57



<b>Product Code</b>	<b>Product Description</b>	<b>Page</b>
XLBF-NS	Masters Series – Bridge	57
XLBR-SR	Masters Series – Return Top	60
XLBR-SR	Masters Series – Return Top	60
XLCN-22	Masters Series – Shell — Corner	59
XLDF-LB	Masters Series – Double Pedestal Bow Top Desk with Full Overlay Modesty	23
XLDF-LF	Masters Series – Double Pedestal Rectangular Top Desk with Full Overlay Modesty	22
XLDH-LB	Masters Series – Double Pedestal Bow Top Desk with Inset Modesty	25
XLDH-LF	Masters Series – Double Pedestal Rectangular Top Desk with Inset Modesty	24
XLFS-SN	Masters Series – Modular Components — T-Support Panel	143
XLGS	Masters Series – Modular Components — L-Support Panel	140
XLND-NS	Masters Series – Convergent D-Worktop with Column	49
XLNG-4260	Masters Series – Height Adjustable Convergent Worktop — T-Leg – Wedge Radius	36
XLNG-4272	Masters Series – Convergent Worktop for use with 1.5H Storage — Wedge Radius with Column or Hoop	40
XLNP-LS	Masters Series – Convergent P-Worktop with Column	50
XLNP-RS	Masters Series – Convergent P-Worktop with Column	50
XLNR-3060	Masters Series – Height Adjustable Convergent Worktop — T-Leg – Rectangular	32
XLNR-3072	Masters Series – Convergent Worktop for use with 1.5H Storage — Rectangular with Column or Hoop	38
XLNW-4260	Masters Series – Height Adjustable Convergent Worktop — T-Leg – Wedge Square	34
XLNW-4272	Masters Series – Convergent Worktop for use with 1.5H Storage — Wedge Square with Column or Hoop	39
XLNY-NB	Masters Series – Full Wedge Square Convergent Worktop with Column and Stanchions	51
XLNY-NS	Masters Series – Full Wedge Square Slip Fit Convergent Worktop with Column	52
XLNY-YC	Masters Series – Full Wedge Square Convergent Worktop with Column	51
XLNZ-NB	Masters Series – Half Wedge Square Convergent Worktop with Column and Stanchions	54
XLNZ-NS	Masters Series – Half Wedge Square Slip Fit Convergent Worktop	55
XLNZ-YC	Masters Series – Half Wedge Square Convergent Worktop with Column	53
XLRL-LS	Masters Series – Return with 30" Wide Lateral File	62
XLRP-RS	Masters Series – Return with Pedestal	61
XLS1-3060	Masters Series – Shroud for use with Height Adjustable T-Leg	41
XLSF-LB	Masters Series – Single Pedestal Bow Top Desk with Full Overlay Modesty	19
XLSF-LF	Masters Series – Single Pedestal Rectangular Top Desk with Full Overlay Modesty	18
XLSP-LB	Masters Series – Single Pedestal Bow Top Desk with Inset Modesty	21
XLSP-LF	Masters Series – Single Pedestal Rectangular Top Desk with Inset Modesty	20
XLTH-FL	Masters Series – Convergent T-Worktop – Rectangular	43
XLWF	Masters Series – Modular Component — Credenza Top	131
XLWT-SN	Masters Series – Common Storage Top with Two Profiled Edges	130
XLXS-2260	Masters Series – Modesty Panel for Shroud	42
XLYD-SF	Masters Series – Convergent D-Worktop with T-Support and Column	45
XLYD-SP	Masters Series – Convergent D-Worktop with T-Support and Column	45
XLYH-SB	Masters Series – Shell — Bow Top Desk	27
XLYH-SF	Masters Series – Shell — Rectangular Top Desk	26
XLYP-SF	Masters Series – Convergent P-Worktop with T-Support and Column	47
XLYP-SP	Masters Series – Convergent P-Worktop with T-Support and Column	47
XLZR-2460	Masters Series – Height Adjustable Credenza Desk — Rectangular – T-Leg Base	65
XTNP-RS	Masters Series – Convergent P-Worktop with Column	50
XWBB	Masters Series – Mounting Bracket Masters Overhead Storage Unit to Enclose	122
XZAM-1S	Masters Series – Table — Round	178
XZAR-3060	Masters Series – Height Adjustable Table Desk — Rectangular Top — T-Leg Base	30
XZAR-3072	Masters Series – Table Desk — Rectangular — Hoop Leg	28
XZAS-3030	Masters Series – Square Tables	178
XZBF-FS	Masters Series – Bridge	57
XZBF-NS	Masters Series – Bridge	57
XZBR-SR	Masters Series – Return Top	60
XZBR-SR	Masters Series – Return Top	60
XZCN-22	Masters Series – Shell — Corner	59

# Index

<b>Product Code</b>	<b>Product Description</b>	<b>Page</b>
XZDF-WB	Masters Series – Double Pedestal Bow Top Desk with Full Overlay Modesty	.23
XZDF-WF	Masters Series – Double Pedestal Rectangular Top Desk with Full Overlay Modesty	.22
XZDH-WB	Masters Series – Double Pedestal Bow Top Desk with Inset Modesty	.25
XZDH-WF	Masters Series – Double Pedestal Rectangular Top Desk with Inset Modesty	.24
XZEC-NGB	Masters Series – Column Base	.181
XZFS-SN	Masters Series – Modular Components — T-Support Panel	.143
XZGS	Masters Series – Modular Components — L-Support Panel	.140
XZLR-RB	Masters Series – L-Shaped Reception Station	.128
XZND-NS	Masters Series – Convergent D-Worktop with Column	.49
XZNG-4260	Masters Series – Height Adjustable Convergent Worktop — T-Leg – Wedge Radius	.36
XZNG-4272	Masters Series – Convergent Worktop for use with 1.5H Storage — Wedge Radius with Column or Hoop	.40
XZNP-LS	Masters Series – Convergent P-Worktop with Column	.50
XZNP-RS	Masters Series – Convergent P-Worktop with Column	.50
XZNR-3060	Masters Series – Height Adjustable Convergent Worktop — T-Leg – Rectangular	.32
XZNR-3072	Masters Series – Convergent Worktop for use with 1.5H Storage — Rectangular with Column or Hoop	.38
XZNW-4260	Masters Series – Height Adjustable Convergent Worktop — T-Leg – Wedge Square	.34
XZNW-4272	Masters Series – Convergent Worktop for use with 1.5H Storage — Wedge Square with Column or Hoop	.39
XZNY-NB	Masters Series – Full Wedge Square Convergent Worktop with Column and Stanchions	.51
XZNY-NS	Masters Series – Full Wedge Square Slip Fit Convergent Worktop with Column	.52
XZNY-YC	Masters Series – Full Wedge Square Convergent Worktop with Column	.51
XZNZ-NB	Masters Series – Half Wedge Square Convergent Worktop with Column and Stanchions	.54
XZNZ-NS	Masters Series – Half Wedge Square Slip Fit Convergent Worktop	.55
XZNZ-YC	Masters Series – Half Wedge Square Convergent Worktop with Column	.53
XZRL-LS	Masters Series – Return with 30" Wide Lateral File	.62
XZRP-RS	Masters Series – Return with Pedestal	.61
XZS1-3060	Masters Series – Shroud for use with Height Adjustable T-Leg	.41
XZSC-2116-FA	Masters Series – Storage Cushion	.147
XZSF-WB	Masters Series – Single Pedestal Bow Top Desk with Full Overlay Modesty	.19
XZSF-WF	Masters Series – Single Pedestal Rectangular Top Desk with Full Overlay Modesty	.18
XZSP-WB	Masters Series – Single Pedestal Bow Top Desk with Inset Modesty	.21
XZSP-WF	Masters Series – Single Pedestal Rectangular Top Desk with Inset Modesty	.20
XZTH-FL	Masters Series – Convergent T-Worktop – Rectangular	.43
XZUR-RB	Masters Series – U-Shaped Reception Station	.129
XZWF	Masters Series – Modular Component — Credenza Top	.131
XZWT-SN	Masters Series – Common Storage Top with Two Profiled Edges	.130
XZXS-2260	Masters Series – Modesty Panel for Shroud	.42
XZYD-SF	Masters Series – Convergent D-Worktop with T-Support and Column	.45
XZYD-SP	Masters Series – Convergent D-Worktop with T-Support and Column	.45
XZYH-SB	Masters Series – Shell — Bow Top Desk	.27
XZYH-SF	Masters Series – Shell — Rectangular Top Desk	.26
XZYP-SF	Masters Series – Convergent P-Worktop with T-Support and Column	.47
XZYP-SP	Masters Series – Convergent P-Worktop with T-Support and Column	.47
XZZL-BN	Masters Series – Credenza with 36" Wide Lateral Files	.68
XZZM-BY	Masters Series – Credenza with 30" Wide Lateral Files and Kneespace	.69
XZZP-BY	Masters Series – Credenza with Pedestals	.63
XZZR-2460	Masters Series – Height Adjustable Credenza Desk — Rectangular – T-Leg Base	.65
XZZS-YL	Masters Series – Credenza with Pedestals and Closed Storage	.67
ZUBF-0000-PN	Masters Series – Flush Mount Plate	.179

## Product Compatibility and Limited Warranty Policy

### Great Expectations

You have them as a Haworth customer and so do we. And because we value our customers, we cover our products with the Haworth North America Product Compatibility and Limited Warranty Policy.

### Our Commitment To Product Compatibility – Integrated Product Platforms

As a market leader in the design and manufacture of workspaces that adapt to change, we strive to maintain product compatibility within our various generations of integrated product platforms. This benefits the customer who desires to update or modify their work environment. It also benefits the customer needing to replace a product due to damage or other reasons but which is no longer manufactured or is otherwise unavailable, such as a fabric or finish that is discontinued because of changing market preferences. In both circumstances, we often can provide products with comparable function and performance.

### Our Commitment To Product Quality – The Haworth North America Limited Warranty

To ensure customer satisfaction and peace of mind, we stand behind our products with the Haworth North America Limited Warranty. To review the current version of the limited warranty including its terms and conditions, please go to:

**[www.haworth.com/warranty](http://www.haworth.com/warranty) or contact [OneTouch@Haworth.com](mailto:OneTouch@Haworth.com) or 1 877 429 6784.**

### Warranty Requests or Questions

For questions or service requests pertaining to the Haworth Limited Warranty, please contact your Haworth dealer.

If you are unsure who your dealer is, please contact **[OneTouch@Haworth.com](mailto:OneTouch@Haworth.com) or 1 877 429 6784.**

**Effective: September 1, 2021**

## Terms of Sale

The Terms of Sale apply to all products in the North America Price Lists. To review the current version of the North American Terms of Sale, please go to:

**[www.haworth.com/terms-of-sale](http://www.haworth.com/terms-of-sale) or contact [OneTouch@Haworth.com](mailto:OneTouch@Haworth.com) or 1 877 429 6784.**

**Effective: September 2, 2022**

HAWORTH®

HAWORTH® is a registered trademark of Haworth, Inc.  
© Haworth, Inc. All rights reserved. 2024 2.24 | Item #LIT21020  
haworth.com | 800 344 2600