

HAWORTH

Return to Work(place) Product Catalog

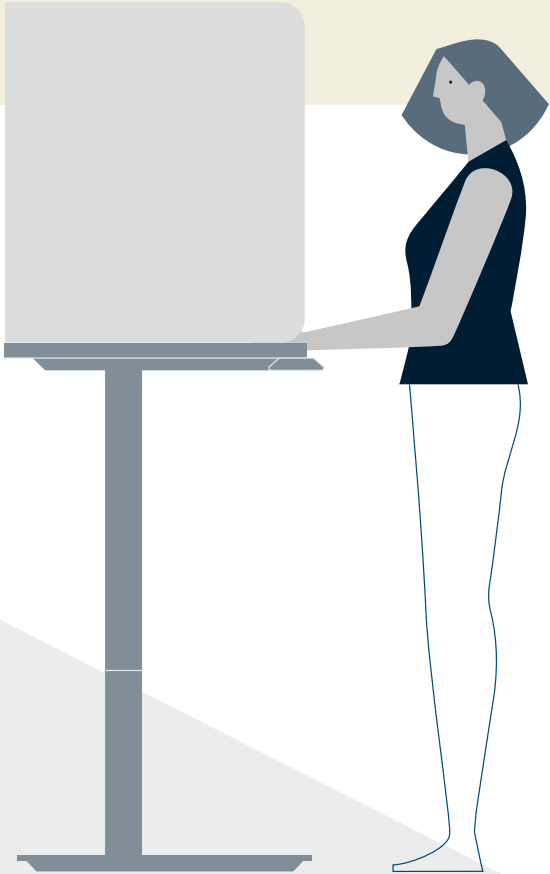
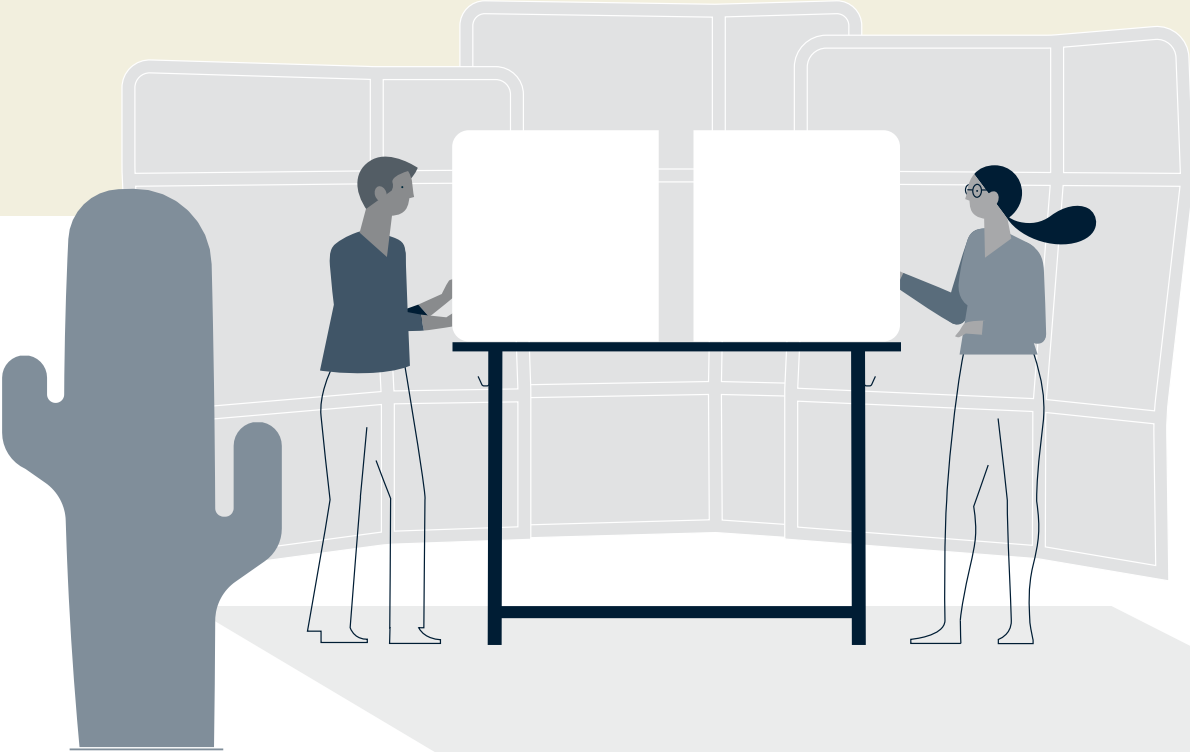

Return to Work(place) Product Catalog

We're here to help you quickly get back to the office when the time is right. These products provide you with solutions that balance the needs of people and space to create a safe and comfortable environment for your employees, while addressing facility requirements and preserving your organizational culture.

Contents

Desktop & Desk-Mounted Screens
Freestanding Territory & Wayfinding Screens
Task Seating Choices for Cleanability

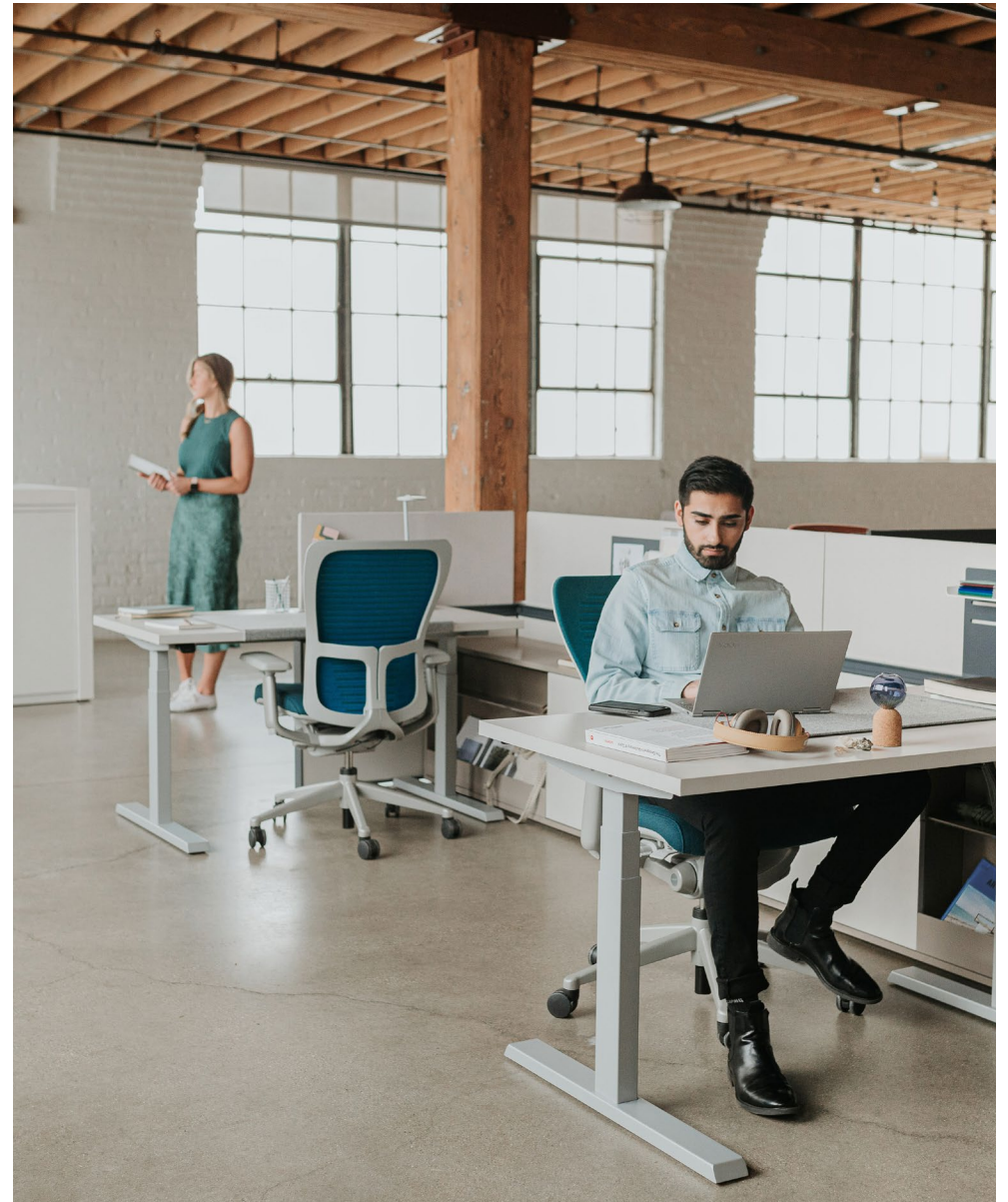

Desktop & Desk-Mounted Screens

Lightweight Desktop Separation Screen

Made from easily disinfected corrugated plastic, this lightweight, corrugated plastic screen provides three-sided privacy for the user on fixed or height-adjustable table surfaces. Attaches with dual-sided, damage-free adhesive. Adjusts in width 42" – 72". Available in 24" and 30" heights.

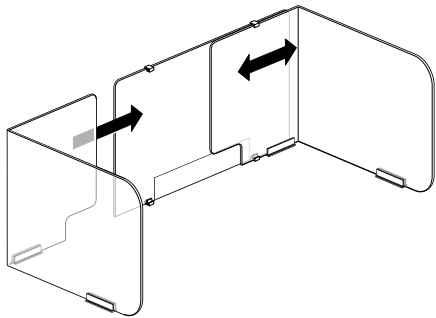

Lightweight Desktop Separation Screen Expanded



Affordable solution for new or existing benching, as well as fixed and height-adjustable tables



Cutouts accommodate cords and select monitor arms

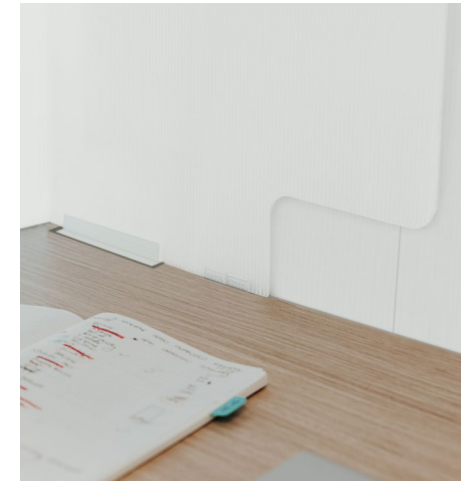

Adjustable 42" – 72" wide

Acrylic Desktop Separation Screen

Made from easily disinfected acrylic plastic, this durable acrylic desktop screen provides three-sided privacy and can be placed on fixed or height-adjustable surfaces. Sits securely on desktop with anti-slip, damage-free rubber bumpers. Available in an assortment of sizes to accommodate a variety of workspaces. Translucent finish only.

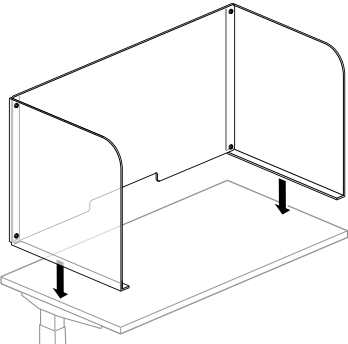

Acrylic Desktop Separation Screen



Universal solution for new or existing benching, as well as fixed and height-adjustable tables



Rests securely on surface with rubber bumpers



Cutouts accommodate cords and select monitor arms

Belong™ Desk-Mounted Screens

Available in cleanable and easily disinfected glass, laminate, veneer, and fabric choices, these back and center screens attach via brackets to most fixed and height-adjustable worksurfaces. Offered in a range of heights and widths for a variety of applications.

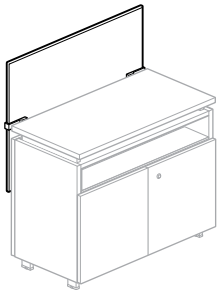

Back Screen on Storage

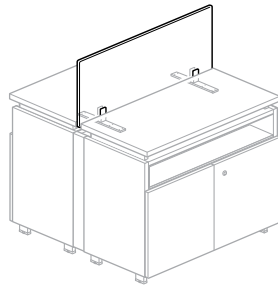

Center Screen on Storage

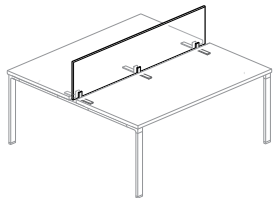

Center Screen on Worksurface



Veneer back screen adds a look of elegance



Works with 120° applications



Mounts to fixed or height-adjustable worksurfaces

Belong™ Territory Screens

Made from easily disinfected painted metal in a variety of colors, these screens provide territory delineation and separation between users. May be used atop fixed and height-adjustable surfaces.

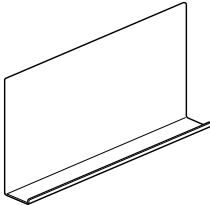

Territory End-of-Run Screen

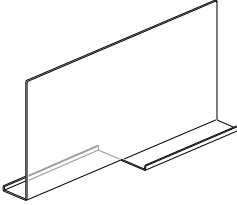

Territory Shared Screen

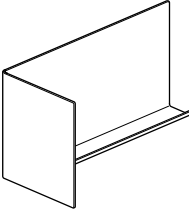

Territory L-Screens - Left-Hand

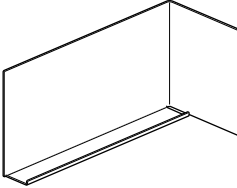

Territory L-Screens - Right-Hand



Shared screens offer protection for users on either side



Corner screens provide protection for worksurface intersections

Belong™ Plus Center Screens

These tackable fabric center screens are available in cleanable and easily disinfected fabrics. They may also be ordered in bleach cleanable fabrics for enhanced cleanability. Ideal for use with Compose Connections™, Compose® Beam, Planes® benching, Intuity®, and Reside® products.

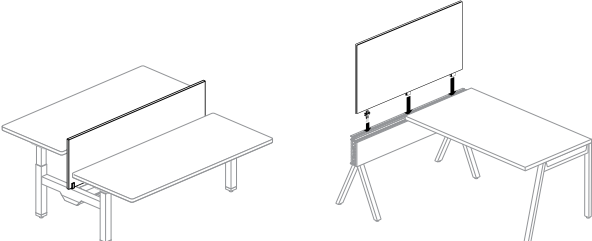

Center Screen

Center Screen on Compose Beam



Ideal for spine-based applications



Tackable for visual reference tools



May be added to a variety of workspace products

Belong™ Plus Back Screens

These tackable fabric back screens are available in cleanable and easily disinfected fabrics. They may also be ordered in bleach cleanable fabrics for enhanced cleanability. Attach with brackets to fixed or height-adjustable tables and benching.

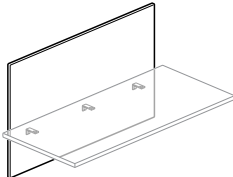

Back Screen on Height-Adjustable Table

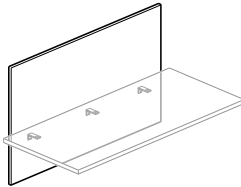

Center Screen on Fixed-Height Worksurface



Minimalistic design complements light-scale applications



Mounts to fixed or height-adjustable worksurfaces



Tackable to support cognitive cues

Belong™ Plus End Screens

These tackable fabric end screens are available in cleanable and easily disinfected fabrics. They may also be ordered in bleach cleanable fabrics for enhanced cleanability. Attach with brackets to provide physical barriers at the ends of fixed or height-adjustable tables and benching.

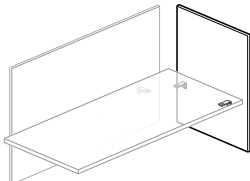

End Screen on Fixed-Height Worksurface

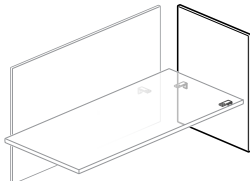

End Screen on Height-Adjustable Table

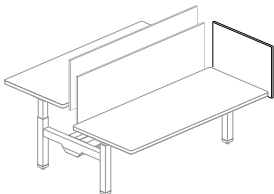

End Screen on Height-Adjustable Benching

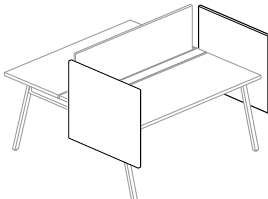

End Screen on Benching



Provides an end barrier for sit-to-stand applications

Belong™ Plus Territory Screens

These tackable fabric territory screens are available in cleanable and easily disinfected fabrics. They may also be ordered in bleach cleanable fabrics for enhanced cleanability. Attach with brackets to provide territory delineation and separation between users. May be used on fixed and height-adjustable surfaces.

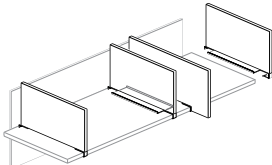

Territory Screen on Fixed-Height Worksurface

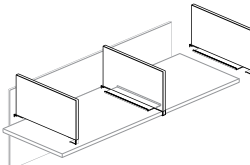

Territory Screen on Height-Adjustable Table



Light-scale screens are ideal for spine-based applications



Extended depth promotes physical separation of users in a variety of applications

Gallery End Panels

Available in easily disinfected laminate, markerboard, and veneer options. These panels add a finished look to workstation ends, while indicating aisleways for traffic. May be used with Compose, Compose Connections, Intuity, Planes height-adjustable benching and Reside desking.

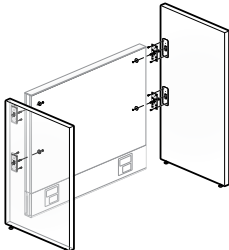

L-Mount Panel

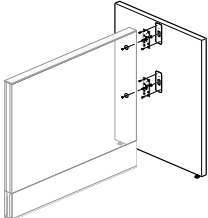

T-Mount Panel



Separate workspaces from passersby

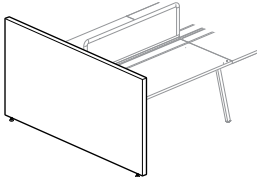

Universal Panel

Tailored Solutions™ Gallery Panels & Desktop Screens

Haworth's Tailored Solutions team can create the custom solutions for any unique needs you may have as you return to the workplace.

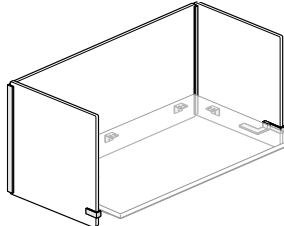

Wrap-Around Screen

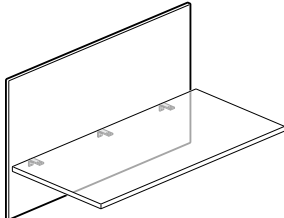

Back Screen

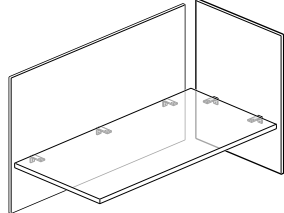

End-Mount Screen

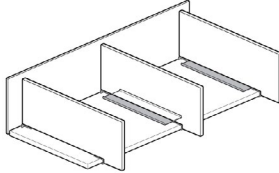

Territory Screen



Customized solutions for any environment



Unique designs and configurations

Active Components™ Center and Corner Screens

These tackable screens are available in a variety of washable fabrics. The center screen mounts to the Intuity rail, Compose Connections work rail, or Active Components screen carriage and rail. The corner screen mounts to Active Components convergent worksurfaces with a 3" minimum corner radius.

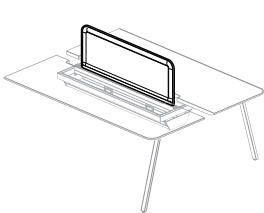

Center Screen

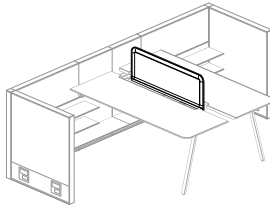

Center Screen

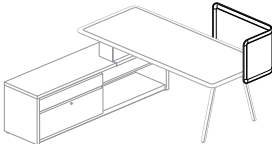

Wrap-Around Screen



Back screen promotes workspace separation while keeping a more open feel



Rounded corners offer a contemporary barrier to traffic areas



Wrap-around protection for open corners

Active Components Territory Screen

With a light-scale tackable design, this screen may be ordered in a variety of washable fabrics to provide territory delineation between users. Designed to be used with Active Components worksurfaces.

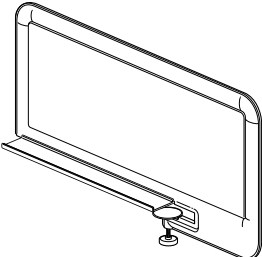

Active Components
Territory Screen



Territory and center screens delineate individual workspaces in shared environments



Territory screens pair with center screens to create convergent workspace separation

Freestanding Territory & Wayfinding Screens

BuzziSpace Screens

BuzziSpace offers a variety of unique freestanding screens in washable fabrics to create barriers that delineate space and traffic patterns to help maintain physical distancing.



BuzziCactus



BuzziFree



BuzziFrio

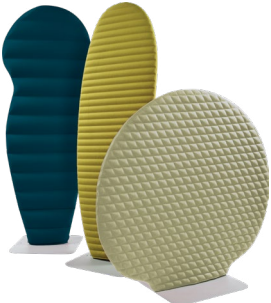

BuzziPlant



BuzziScreen Mix

Planes Easels

Made from easily disinfected painted metal and markerboard surfaces, Planes easels may be used as barriers to delineate space and create traffic patterns that help maintain physical distancing. Casters allow for easy mobility as needed.



Easels with markerboard surfaces serve as mobile barriers and work tools



Large Easel



Standard Easel

Openest® Plume Screens

Plume screens may be ordered in a variety of washable fabrics. Available in three configurations, these screens can delineate space, provide workpoint separation, and create traffic patterns to maintain physical distancing.



Plume 3 screen can act as a barrier to foot traffic

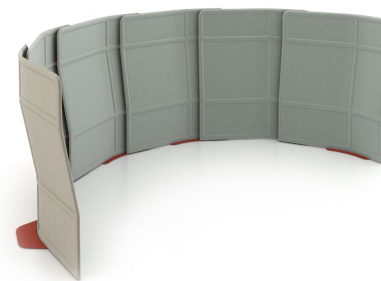

Wider curved Plume 6 screen offers extended protection



Plume 9 screen creates a more private enclosure

Task Seating Choices for Cleanability

Very® & Zody® Task Chairs

As with all Haworth task seating, Very and Zody are cleanable with soap and water or disinfecting wipes. A variety of seat upholstery and back jacket material options, including bleach cleanable fabrics, faux leathers, and leather, offer design choices for advanced disinfection.



Very with back jacket



Zody with back jacket

Fern® & Soji® Task Chairs

As with all Haworth task seating, Fern and Soji are cleanable with soap and water or disinfecting wipes. A variety of full upholstery material options, including bleach cleanable fabrics, faux leathers, and leather, offer design choices for advanced disinfection.



Fern with upholstery on seat and back



Soji with upholstery on seat and back

Haworth Expertise

We know you are anxious to get back to the workplace—so are we. In this new normal, we all seek balance between working remotely and seeing our real coworkers. Through our understanding of employee well-being, organizational culture, and floorplate transformation, Haworth is here to assist with knowledge-based solutions. From floorplate to workpoint, we will help you prioritize the needs of your people, support your culture, and leverage existing products so you can get back to business with ease.

Want to learn more?

Get more in-depth information about how Haworth can help your organization navigate returning to the workplace in a COVID-19 world by visiting haworth.com/rtw.

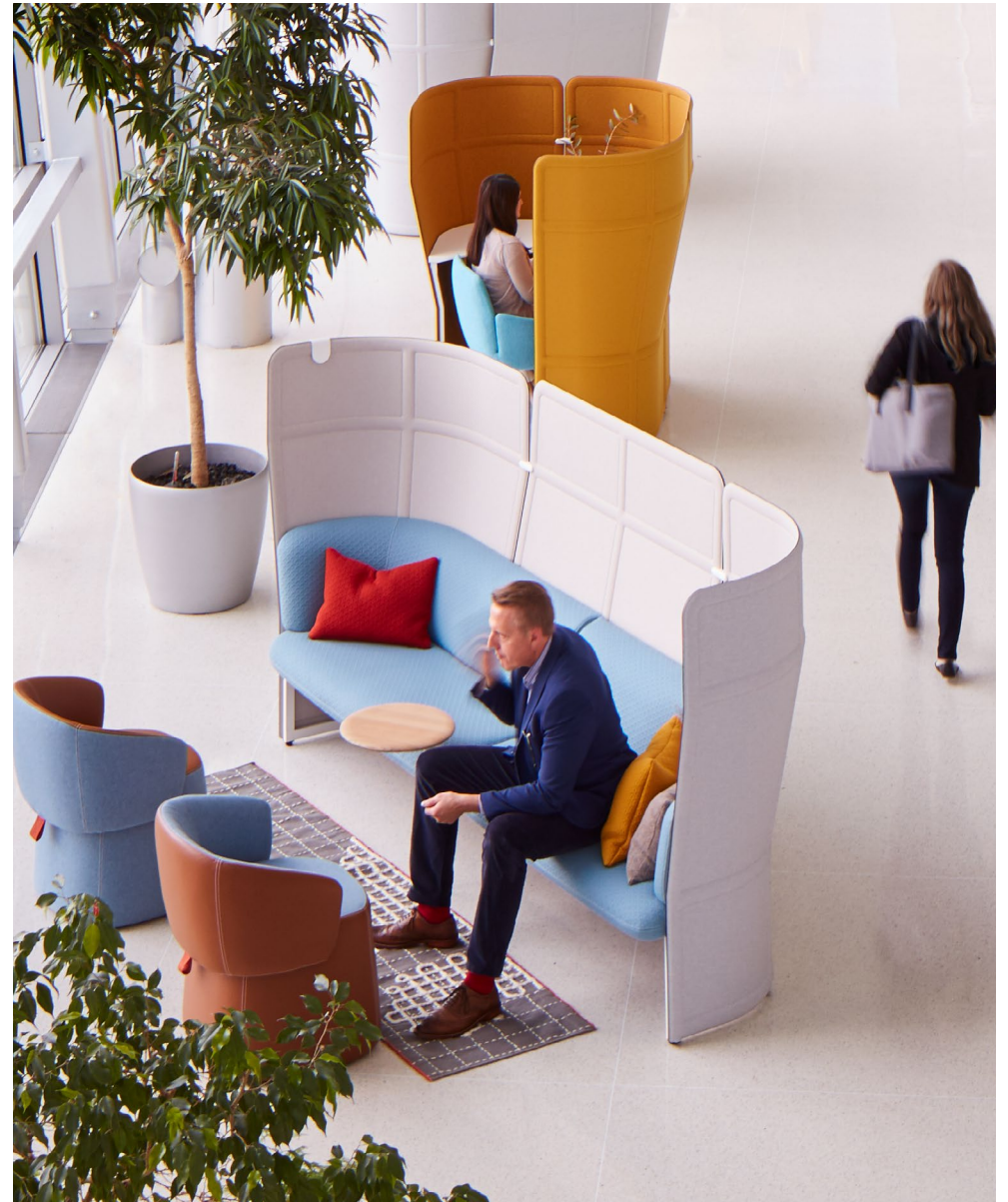

HAWORTH® is a registered trademark of Haworth, Inc.

© Haworth, Inc. All rights reserved. 2020 5.20

haworth.com | 800 344 2600